

2024

MARGRES
CERAMIC TILES

[index](#)



[colour map](#)



[collections](#)



[linea collections](#)



[useful information](#)



MARGRES
CERAMIC TILES

2024

index

— index . index . índice

sizes' index

— index formats . index formate . índice formatos —

collections

| | |
|------------|--------|
| concept | P. 139 |
| endless | P. 57 |
| evoke | P. 105 |
| grove | P. 153 |
| hybrid | P. 93 |
| jungle | P. 117 |
| metropolis | P. 23 |
| natural | P. 187 |
| prestige | P. 127 |
| pure stone | P. 69 |
| slabstone | P. 175 |
| stage | P. 43 |
| subway | P. 191 |
| tecnica | P. 217 |
| time 2.0 | P. 201 |
| tool | P. 163 |

linea collections

| | |
|------------|--------|
| cosmos | P. 259 |
| endless | P. 227 |
| magnetic | P. 251 |
| prestige | P. 271 |
| pure stone | P. 243 |
| slabstone | P. 279 |
| subway | P. 287 |
| time 2.0 | P. 295 |
| tool | P. 263 |

useful information

| | |
|--------------------------|--------|
| calibers | P. 336 |
| certification | P. 310 |
| colour map | P. 8 |
| general sales conditions | P. 340 |
| important notes | P. 347 |
| margres green | P. 308 |
| laying suggestions | P. 339 |
| outdoor extra thick | P. 318 |
| package | P. 334 |
| pr()tect | P. 304 |
| symbols | P. 338 |
| technical information | P. 322 |
| think zero | P. 306 |

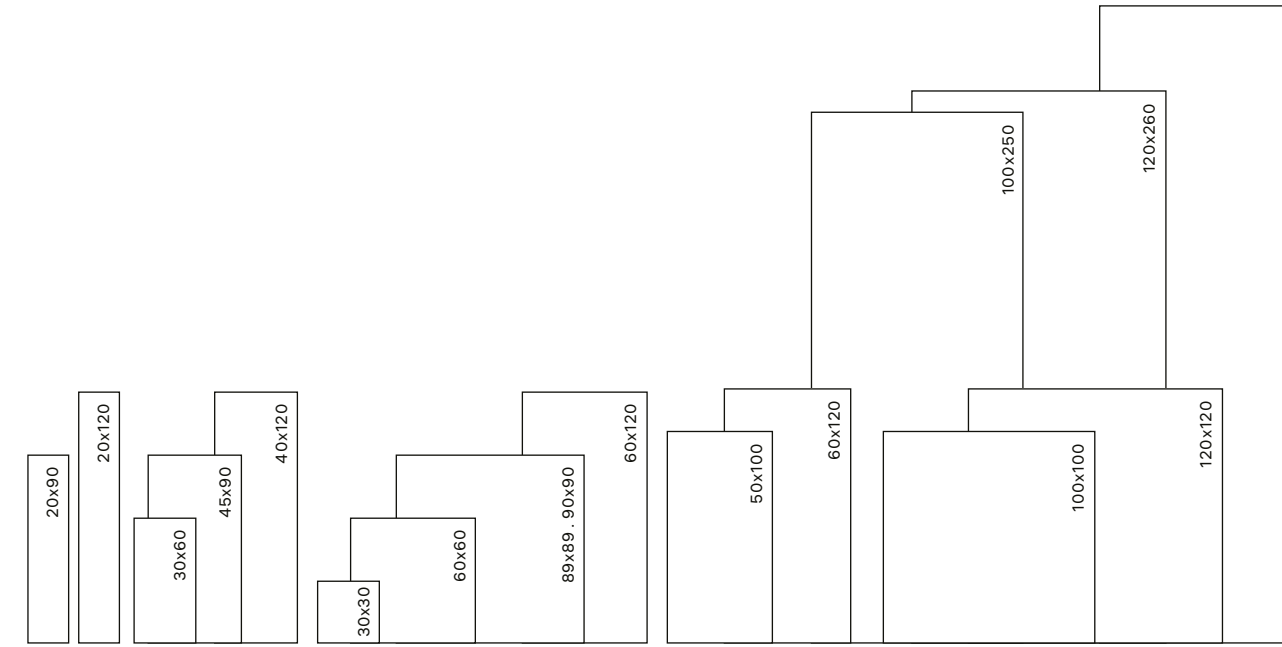

| | | LINEA | | | | | | | | | | | | | | | | | |
|------------|--------|-------|--------|-------|-------|--------|-------|-------|--------|-------|-------|---------|--------|--------|---------|---------|---------|---------|---------|
| | | 20x90 | 20x120 | 30x30 | 30x60 | 40x120 | 45x90 | 60x60 | 60x120 | 89x89 | 90x90 | 120x120 | 50x100 | 60x120 | 100x100 | 100x250 | 100x300 | 120x120 | 120x260 |
| concept | P. 139 | | | | ■ | | ■ | ■ | ■ | | ■ | ■ | | | | | | | |
| cosmos | P. 259 | | | | | | | | | | | | | | ■ | | ■ | | |
| endless | P. 57 | | | | | | | | ■ | ■ | ■ | | ■ | | ■ | ■ | ■ | | |
| evoke | P. 105 | | | | ■ | | | ■ | ■ | | ■ | | | | | | | | |
| grove | P. 153 | | ■ | | | ■ | | | | | | | | | | | | | |
| hybrid | P. 93 | | | | ■ | | | ■ | ■ | | ■ | | | | | | | | |
| jungle | P. 117 | | ■ | | | ■ | | | | | | | | | | | | | |
| magnetic | P. 251 | | | | | | | | | | | | | | ■ | | ■ | | |
| metropolis | P. 23 | | | | ■ | | | ■ | ■ | | ■ | ■ | | | | | | | |
| natural | P. 187 | ■ | | | | | | | | | | | | | | | | | |
| prestige | P. 127 | | | | | | | ■ | ■ | ■ | ■ | | ■ | | ■ | ■ | ■ | | |
| pure stone | P. 69 | | | | ■ | | | ■ | ■ | | ■ | ■ | ■ | ■ | ■ | ■ | ■ | | |
| slabstone | P. 175 | | | | ■ | | ■ | ■ | | | ■ | | ■ | | ■ | | ■ | | |
| stage | P. 43 | | ■ | | | | | | ■ | | | | | | | | | | |
| subway | P. 191 | | | | ■ | | ■ | ■ | | | ■ | | ■ | | ■ | | ■ | | |
| tecnica | P. 217 | | | ■ | | | | | | | | | | | | | | | |
| time 2.0 | P. 201 | | | | ■ | | | ■ | ■ | | ■ | | ■ | | ■ | | ■ | | |
| tool | P. 163 | | | | | | ■ | ■ | | ■ | | | ■ | | | | | ■ | ■ |

index

anti-slip's

finishes

sizes

sizes +finishes
+ thickness

thickness

colour map

collections

linea collections

useful information

finishes' index

— index finitions . index fertigungen . índice acabamentos

| | | A | AS | ASR | E | E ASR | E NR | K | N | NR | SL | SM | P | TC | W |
|-------------------|--------|---|----|-----|---|-------|------|---|---|----|----|----|---|----|---|
| concept | P. 139 | ■ | | ■ | | | | | | ■ | | | | | |
| cosmos | P. 259 | | | | | | | | | ■ | | | | | |
| endless | P. 57 | | | ■ | | | | | | | | ■ | ■ | | |
| evoke | P. 105 | | | ■ | ■ | | | | | ■ | | | | ■ | |
| grove | P. 153 | | ■ | | ■ | | | | ■ | | | | | | |
| hybrid | P. 93 | | | ■ | | | | | | ■ | | | | ■ | |
| jungle | P. 117 | | ■ | | ■ | | | | ■ | ■ | | | | | |
| magnetic | P. 251 | | | | | | | | | ■ | | | | | |
| metropolis | P. 23 | ■ | | ■ | | | | | | ■ | | | | ■ | |
| natural | P. 187 | | | | | | | ■ | ■ | | ■ | | | | |
| prestige | P. 127 | | | ■ | | | | | | ■ | | | ■ | | |
| pure stone | P. 69 | ■ | | ■ | ■ | | | | | ■ | | | | | |
| slabstone | P. 175 | ■ | | ■ | ■ | | | | | ■ | | | | | |
| stage | P. 43 | ■ | | | | | | | | ■ | | | | | |
| subway | P. 191 | ■ | | | ■ | | | | | ■ | | | | | |
| tecnica | P. 217 | | ■ | | ■ | | | | ■ | | | | | | ■ |
| time 2.0 | P. 201 | | | ■ | | ■ | | | | ■ | | | ■ | | |
| tool | P. 163 | ■ | | ■ | ■ | | | | | ■ | | | | ■ | |

reference finishing

— référence
— referenz
— referênciã

— finition
— fertigung
— acabamentoo

| | |
|---------------|---|
| A* | soft shiny . adouci . halbpoliert . amaciado |
| AS | anti-slip . antidérapant . rutschfest . antiderrapante |
| ASR | anti-slip rectified . antidérapant rectifié . rutschfest rektifiziert . antiderrapante retificado |
| E | extra thick . forte épaisseur . überdicke fliese . espessurado |
| E ASR* | extra thick anti-slip . forte épaisseur antidérapant . rutschfestig überdicke fliese . espessurado antiderrapante |
| E NR | extra thick nat. rectified . forte épaisseur nat. rectifié . nat. rektifiziert überdicke fliese . espessurado nat. retificado |
| K | deck |
| N | natural . naturel . naturbelassen . natural |
| NR | nat. rectified . nat. rectifié . nat. rektifiziert . nat. retificado |
| SL | slat |
| SM* | smooth |
| P* | polished . poli . poliert . polido |
| TC* | touch |
| W | wavy . ondulé . wellig . ondulado |

* always rectified . toujours rectifié . immer rektifiziert . sempre retificado

thickness' index

— index épaisseurs . index dicke . índice espessuras

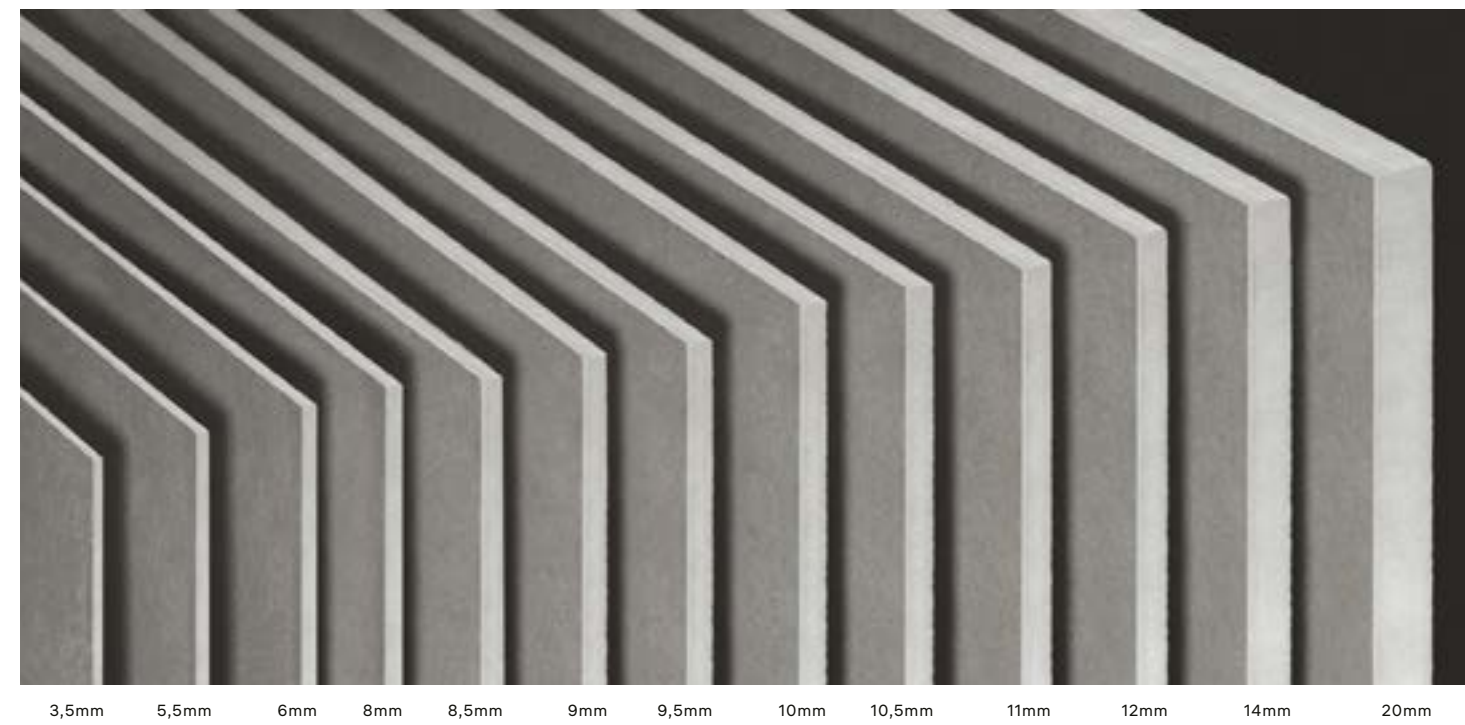

3,5mm 5,5mm 6mm 8mm 8,5mm 9mm 9,5mm 10mm 10,5mm 11mm 12mm 14mm 20mm

| | | LINEA | | | | | | | | | | | | | |
|-------------------|--------|-------|-------|-----|-----|-------|-----|-------|------|--------|------|------|------|------|---|
| | | 3,5mm | 5,5mm | 6mm | 8mm | 8,5mm | 9mm | 9,5mm | 10mm | 10,5mm | 11mm | 12mm | 14mm | 20mm | |
| concept | P. 139 | | | | | | | | ■ | ■ | ■ | | | | |
| cosmos | P. 259 | ■ | | | | | | | | | | | | | |
| endless | P. 57 | | ■ | | | | | | | | ■ | | | | |
| evoke | P. 105 | | | | | | | | ■ | | ■ | | | | ■ |
| grove | P. 153 | | | | | | ■ | | | | | | | | ■ |
| hybrid | P. 93 | | | | | | | | | | ■ | ■ | | | |
| jungle | P. 117 | | | | | | ■ | | | | | | | | ■ |
| magnetic | P. 251 | | | | | ■ | | | | | | | | | |
| metropolis | P. 23 | | | | | | | | ■ | ■ | ■ | | | | |
| natural | P. 187 | | | | | | | | | ■ | | | | | |
| prestige | P. 127 | | ■ | | | | | | ■ | | ■ | | | | |
| pure stone | P. 69 | | | | | ■ | | | ■ | ■ | ■ | | | | ■ |
| slabstone | P. 175 | ■ | | | | | | | ■ | ■ | ■ | | | | ■ |
| stage | P. 43 | | | | | | | | | | ■ | | | | |
| subway | P. 191 | ■ | | | | | | | ■ | ■ | ■ | | | | ■ |
| tecnica | P. 217 | | | | | | | | ■ | | | | ■ | | |
| time 2.0 | P. 201 | ■ | | | | | | | | | ■ | ■ | ■ | | ■ |
| tool | P. 163 | | | | | ■ | | | ■ | ■ | ■ | | | | ■ |

index

anti-slip's

finishes

sizes

sizes + finishes
+ thickness

thickness

colour map

collections

linea collections

useful information

sizes' + finishes' + thickness' index

— index formats + finitions + épaisseurs . index formate + oberfläche + dicke . índice formatos + acabamentos + espessuras

| | | 20x90 | 20x120 | 30x30 | 30x60 | 40x120 | 45x90 | 50x100 | 60x60 | 60x120 | 89x89 | 90x90 | 100x100 | 100x250 | 100x300 | 120x120 | 120x260 |
|-------------------|--------|---------------------|----------------------|------------------------------------|---------------------------------|---------------|--------------------|----------------|--------------------------------------|---------------------------|------------|----------------------------|----------------------|---------------|---------------|-------------|---------|
| concept | P. 139 | | | | NR A 8,5mm | | NR A ASR 9mm | | NR A ASR 8,5mm | NR A 9,5mm | | NR A 9,5mm | | | | NR 9mm | |
| cosmos | P. 259 | | | | | | | | | | | | NR 3,5mm | | NR 3,5mm | | |
| endless | P. 57 | | | | | | | SM P 5,5mm | | SM P 9,5mm | P 9,5mm | SM ASR 9,5mm | SM P 5,5mm | SM P 5,5mm | SM P 5,5mm | | |
| evoke | P. 105 | | | | NR 8,5mm | | | | NR TC ASR 8,5mm | NR TC 9,5mm | | NR TC 9,5mm | | | | | |
| grove | P. 153 | | N AS 8mm | | | E ASR 20mm | | | | | | | | | | | |
| hybrid | P. 93 | | | | NR TC ASR 10mm | | | | NR TC ASR 10mm | NR TC ASR 11mm | | NR TC ASR 11mm | | | | | |
| jungle | P. 117 | | N NR AS 8mm | | | E ASR 20mm | | | | | | | | | | | |
| magnetic | P. 251 | | | | | | | | | | | | NR 6mm | | NR 6mm | | |
| metropolis | P. 23 | | | | NR 8,5mm | | | | NR TC 8,5mm | NR TC ASR 9,5mm | | NR TC A ASR 9,5mm | | | | NR 9mm | |
| natural | P. 187 | N K SL 9mm | | | | | | | | | | | | | | | |
| prestige | P. 127 | | | | | | | NR P 5,5mm | NR P 8,5mm | NR P 9,5mm | P 9,5mm | NR 9,5mm | NR P ASR 5,5mm | NR P 5,5mm | NR P 5,5mm | | |
| pure stone | P. 69 | | | | NR A 8,5mm | | | NR 6mm | NR A ASR 8,5mm | NR A ASR 9,5mm | | NR A ASR 9,5mm | NR 6mm | NR 6mm | NR 6mm | NR A 9mm | |
| slabstone | P. 175 | | | | NR 8,5mm | NR 9mm | NR 3,5mm | | NR A ASR 8,5mm | NR A ASR 9,5mm | | NR ASR 9,5mm | NR 3,5mm | | NR 3,5mm | | |
| stage | P. 43 | | NR A 9,5mm | | | | | | | A 9,5mm | | | | | | | |
| subway | P. 191 | | | | NR 8,5mm | NR 9mm | NR 3,5mm | | NR A ASR 8,5mm | NR A ASR 20mm | | NR 9,5mm | NR 3,5mm | | NR 3,5mm | | |
| tecnica | P. 217 | | | N W AS 8,5mm E 12mm | | | | | | | | | | | | | |
| time 2.0 | P. 201 | | | | NR ASR 10mm P 9,5mm | | | NR 3,5mm | NR ASR 10mm P 9,5mm | NR 11mm P 10,5mm | | NR 11mm P 10,5mm | NR 3,5mm | | NR 3,5mm | | |
| tool | P. 163 | | | | NR ASR 10mm P 9,5mm | | | NR A 9mm | NR TC A 8,5mm E ASR 20mm | NR 6mm | | NR A ASR 9,5mm | | | NR 6mm | NR 6mm | |

anti-slip's index

— index glissement . index rutschen . índice escorregamento

| | | DIN EN 16165 Annex B | | | DIN EN 16165 Annex A | | | DIN EN 16165 Annex C | AS/NZS 4586 | | | ENV 12633 Class | |
|-------------------|--------------|----------------------|-----|----|----------------------|---|---|----------------------|-------------|----|----|-----------------|---|
| | | R11 | R10 | R9 | C | B | A | ≥ 36 | P5 | P4 | P3 | 3 | 2 |
| concept | P. 139 | ■ | ■ | | ■ | ■ | | ■ | | | ■ | ■ | ■ |
| cosmos | P. 259 | | ■ | | | | | | | | | | |
| endless | P. 57 | | ■ | | | ■ | | ■ | | | ■ | | |
| evoke | P. 105 | ■ | ■ | | ■ | ■ | | ■ | | ■ | ■ | | |
| grove | P. 153 | ■ | ■ | | ■ | ■ | | ■ | | ■ | | | |
| hybrid | P. 93 | ■ | ■ | | ■ | ■ | | ■ | ■ | ■ | | ■ | |
| jungle | P. 117 | ■ | ■ | | ■ | ■ | | ■ | | ■ | | | |
| magnetic | P. 251 | | ■ | ■ | | | | | | | | | |
| metropolis | P. 23 | ■ | ■ | | ■ | ■ | | ■ | | ■ | ■ | ■ | ■ |
| natural | P. 187 | ■ | | ■ | ■ | | ■ | ■ | | | | | |
| prestige | P. 127 . 271 | | ■ | | | | | | | | | | |
| pure stone | P. 69 . 243 | | ■ | ■ | ■ | ■ | | ■ | | ■ | ■ | ■ | ■ |
| slabstone | P. 175 . 279 | ■ | ■ | ■ | ■ | ■ | | ■ | | ■ | | | ■ |
| stage | P. 43 | | ■ | | | ■ | | ■ | | | | ■ | |
| subway | P. 191 . 287 | | ■ | | | ■ | | ■ | | ■ | | | |
| tecnica | P. 217 | ■ | ■ | ■ | ■ | ■ | | ■ | | | | ■ | ■ |
| time 2.0 | P. 201 . 295 | ■ | ■ | ■ | ■ | ■ | | ■ | | | | ■ | ■ |
| tool | P. 163 . 263 | ■ | ■ | ■ | ■ | ■ | | ■ | | | | ■ | ■ |

special pieces

pièces spéciales . spezialteile . peças especiais

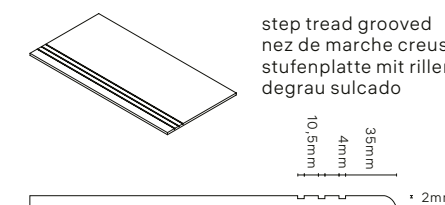

step tread grooved
nez de marche creusé
stufenplatte mit rillen
degrau sulcado

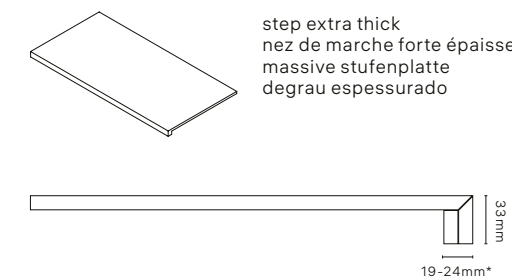

step extra thick
nez de marche forte épaisseur
massive stufenplatte
degrau espessurado

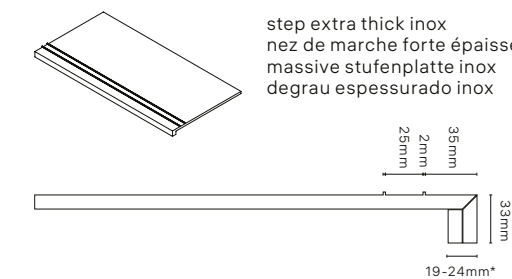

step extra thick inox
nez de marche forte épaisseur inox
massive stufenplatte inox
degrau espessurado inox

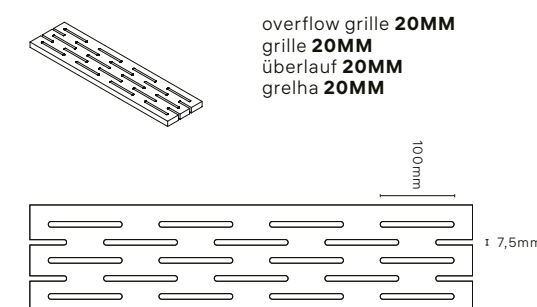

overflow grille **20MM**
grille **20MM**
überlauf **20MM**
grelha **20MM**

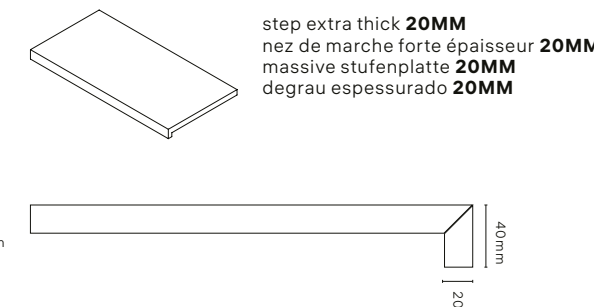

step extra thick **20MM**
nez de marche forte épaisseur **20MM**
massive stufenplatte **20MM**
degrau espessurado **20MM**

* Dimension will vary depending on the base tile thickness.
* La dimension varie selon l'épaisseur du carreau.
* das Maß variiert je nach Dicke der Fliese.
* A dimensão varia consoante a espessura do material cerâmico.

index

anti-slip's

finishes

sizes

sizes + finishes
+ thickness

thickness

colour map

collections

linea collections

useful information

colour map

— stone look

scale 1:3

slabstone white SL1 P. 182



concept white CT1 P. 148



pure stone white PS1 P. 86



hybrid white HB1 P. 100



tecnica branco 44 P. 218



concept beige CT2 P. 148



tecnica granito preto 75 P. 218



slabstone beige SL2 P. 182



concept light grey CT3 P. 149



magnetic stone grey LMS3 P. 257



pure stone light grey PS3 P. 86



slabstone light grey SL4 P. 183



hybrid light grey HB3 P. 101



tecnica platina 41 P. 218



pure stone grey PS4 P. 87



tecnica granito cinza 36 P. 218



colour map

— stone look

1 / 2 ▶

index

colour map

chromatic look

concrete look

marble look

stone look

wood look

collections

linea collections

useful information

colour map

— stone look

◀ 1 / 2

scale 1:3

pure stone beige PS2 P. 86



tecnica granito beige 33 P. 218



hybrid beige HB2 P. 100



slabstone tortora SL3 P. 182



hybrid tortora HB4 P. 101



concept grey CT4 P. 149



slabstone grey SL5 P. 183



hybrid black HB5 P. 101



magnetic stone anthracite LMS4 P. 257



tecnica preto 46 P. 218



colour map

— concrete look

1 / 2 ▶

subway white SW1 P. 196



evoked white EV1 P. 112



metropolis white MT1 P. 36

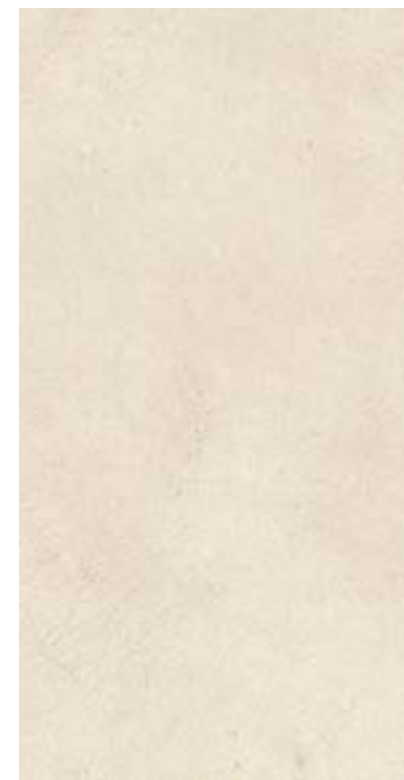

metropolis beige MT2 P. 36



index

colour map

chromatic look

concrete look

marble look

stone look

wood look

collections

linea collections

useful information

colour map

— concrete look

scale 1:3

◀ 1 / 2

tool white TL1 P. 170



evoke light grey EV3 P. 113



tool light grey TL2 P. 171



metropolis light grey MT4 P. 37



subway ash SW2 P. 197



magnetic cement grey LMC1 P. 256



evoke grey EV4 P. 113



metropolis grey MT5 P. 37



evoke beige EV2 P. 112



tool tortora TL3 P. 170



subway clay SW3 P. 196



tool grey TL4 P. 171



subway smoke SW4 P. 197



magnetic cement anthracite LMC2 P. 256



metropolis terracotta MT3 P. 37



colour map

concrete look —

index

colour map

chromatic look

concrete look

marble look

stone look

wood look

collections

linea collections

useful information

colour map

— wood look

scale 1:3

colour map

wood look —

1 / 2 ▶

grove white GR1 P. 160



natural white NT1 P. 188



stage cream SE1 P. 52



jungle beige JU1 P. 125



grove beige GR2 P. 160



natural cream NT2 P. 188

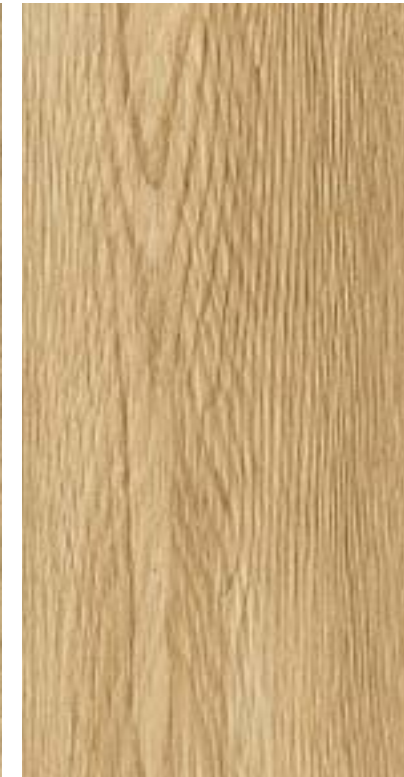

stage beige SE2 P. 52



grove light brown GR5 P. 161



grove grey GR3 P. 160



natural grey NT3 P. 188



grove tortora GR4 P. 161



natural tortora NT4 P. 189



jungle grey JU3 P. 125



natural brown NT5 P. 189

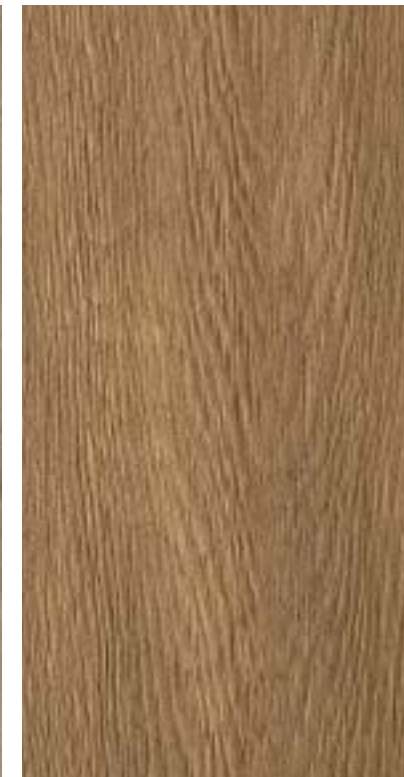

stage brown SE5 P. 52



jungle brown JU2 P. 125



14

15

general catalogue . 2024

general catalogue . 2024

index

colour map

chromatic look

concrete look

marble look

stone look

wood look

collections

linea collections

useful information

colour map

— wood look

◀ 1 / 2

grove brown GR6 P. 161



stage cherry SE4 P. 52



natural wenge NT6 P. 189



— marble look

scale 1:3

prestige calacata PT1 P. 134



prestige corinthian beige PT2 P. 134



endless calacata gold ED1 P. 64



prestige fior di bosco tortora PT4 P. 135



endless breccia capraia ED2 P. 64



prestige emperador black PT5 P. 135



prestige travertino grey PT3 P. 134



endless port black ED4 P. 65

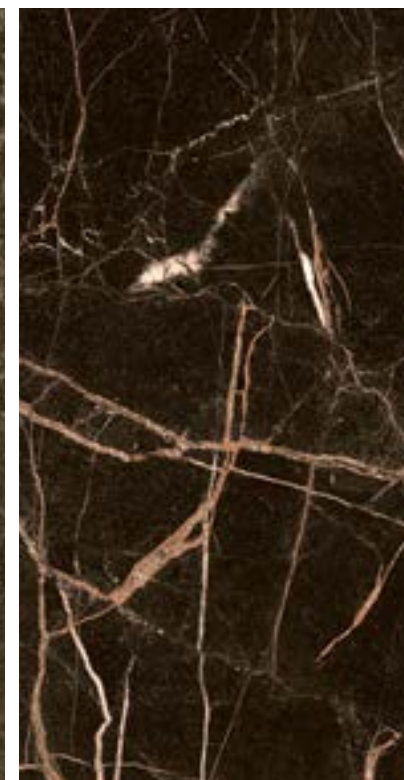

endless travertino ED3 P. 64



endless amazonite ED5 P. 65



colour map

— marble look

index

colour map

chromatic look

concrete look

marble look

stone look

wood look

collections

linea collections

useful information

colour map

— chromatic look

scale 1:3

time 2.0 snow T21 P. 210



time 2.0 white T22 P. 210



time 2.0 cream T23 P. 210



time 2.0 beige T24 P. 211



time 2.0 dove T25 P. 211



cosmos corten LCM1 P. 261



time 2.0 silver T26 P. 212



time 2.0 grey T27 P. 212



time 2.0 carbon T28 P. 213



time 2.0 black T29 P. 213

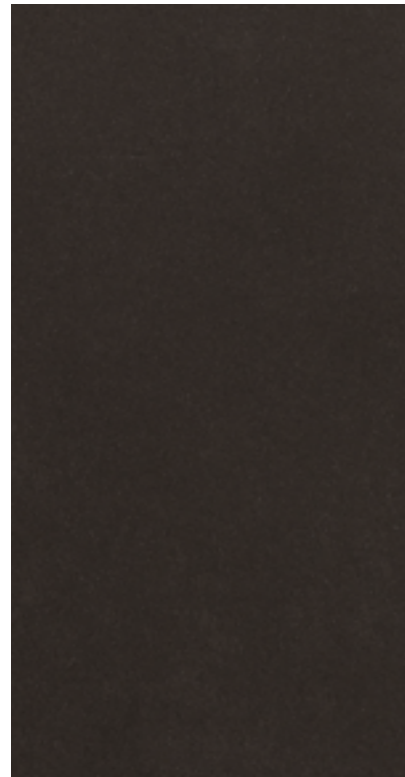

cosmos iron LCM2 P. 261



colour map

chromatic look —

index

colour map

chromatic look

concrete look

marble look

stone look

wood look

collections

linea collections

useful information

collections

collections . kollektionen . coleções —

| | |
|-------------------|--------|
| concept | P. 139 |
| endless | P. 57 |
| evoke | P. 105 |
| grove | P. 153 |
| hybrid | P. 93 |
| jungle | P. 117 |
| metropolis | P. 23 |
| natural | P. 187 |
| prestige | P. 127 |
| pure stone | P. 69 |
| slabstone | P. 175 |
| stage | P. 43 |
| subway | P. 191 |
| tecnica | P. 217 |
| time 2.0 | P. 201 |
| tool | P. 163 |

21

general catalogue . 2024

MARGRES
CERAMIC TILES

index

colour map

collections

concept

endless

evoke

grove

hybrid

jungle

metropolis

natural

prestige

pure stone

slabstone

stage

subway

tecnica

time 2.0

tool

linea collections

useful information



22

general catalogue . 2024

grey MT5 60x120 NR . 120x120 NR

FULL BODY
PORCELAIN

metropolis

collection

↓
DOWNLOAD
CATALOGUE

↓
DOWNLOAD
TECHNICAL
FEATURES

🌐
VIEW
ONLINE

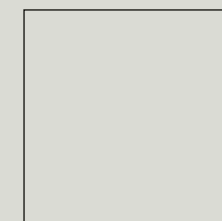

120x120
NR 9mm



60x120
NR . TC . A 9,5mm
ASR 9,5mm



90x90
NR . TC . A 9,5mm
ASR 9,5mm

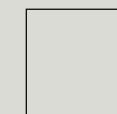

60x60
NR . TC 8,5mm



30x60
NR 8,5mm



white
MT1

beige
MT2

terracotta
MT3

light grey
MT4

grey
MT5

UGL **V2** **R11** **R10**

ASR NR

PROTECT
Antibacterial for Life.

MARGRES
CERAMIC TILES

23

general catalogue . 2024

index

colour map

collections

concept

endless

evoke

grove

hybrid

jungle

metropolis

natural

prestige

pure stone

slabstone

stage

subway

tecnica

time 2.0

tool

linea collections

useful information



24

general catalogue . 2024

25

general catalogue . 2024



26

general catalogue, 2024

white MT1 60x120 NR . 90x90 ASR



27

general catalogue, 2024

beige MT2 60x120 NR . 120x120 NR

index

colour map

collections

concept

endless

evoke

grove

hybrid

jungle

metropolis

natural

prestige

pure stone

slabstone

stage

subway

tecnica

time 2.0

tool

linea collections

useful information



terracotta MT3 60x120 NR

30

general catalogue, 2024



light grey MT4 120x120 NR

general catalogue, 2024

index

colour map

collections

concept

endless

evoke

grove

hybrid

jungle

metropolis

natural

prestige

pure stone

slabstone

stage

subway

tecnica

time 2.0

tool

linea collections

useful information

concept

endless

evoke

grove

hybrid

jungle

metropolis

natural

prestige

pure stone

slabstone

stage

subway

tecnica

time 2.0

tool

linea collections

useful information

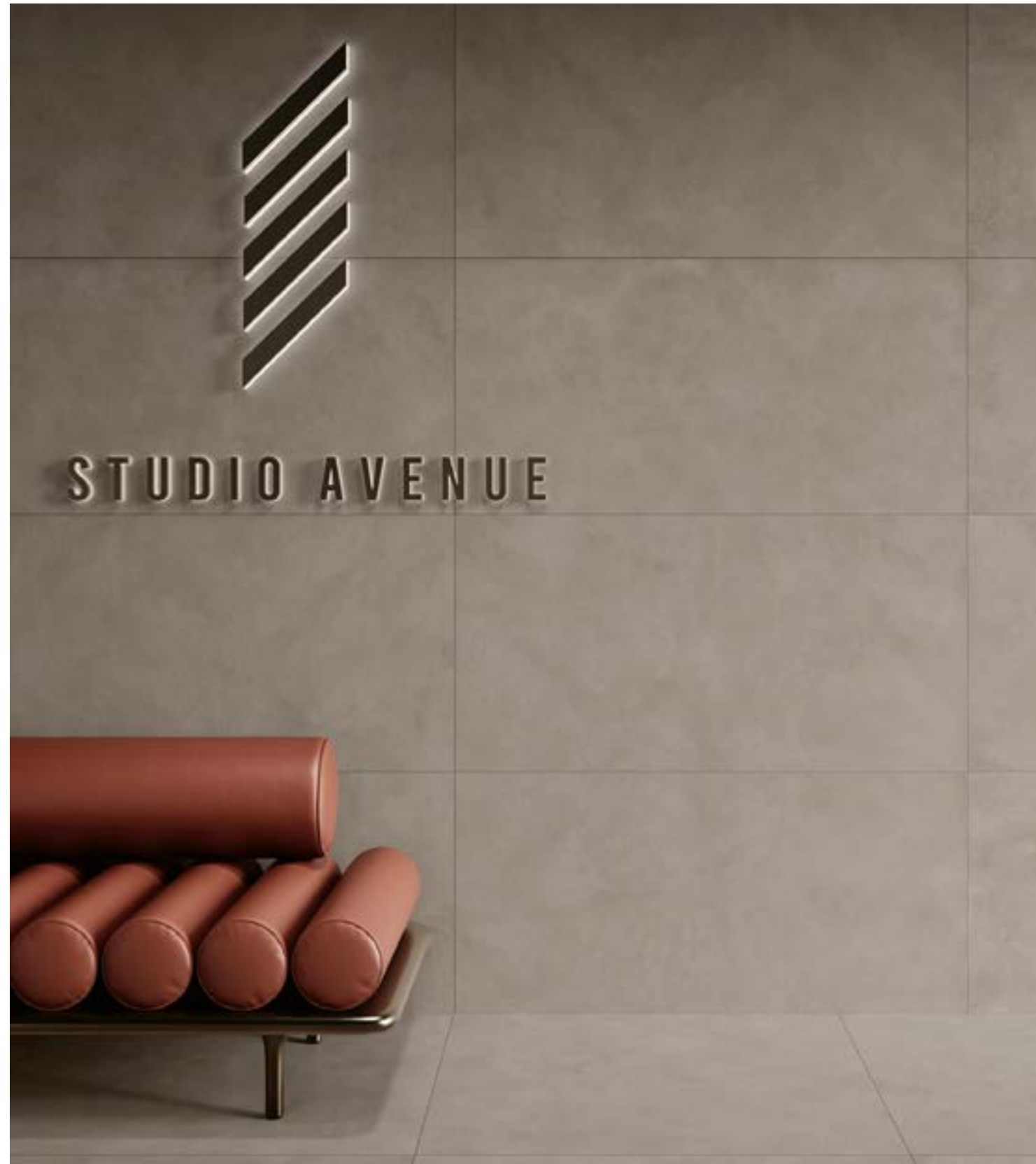

index

colour map

collections

concept

endless

evoke

grove

hybrid

jungle

metropolis

natural

prestige

pure stone

slabstone

stage

subway

tecnica

time 2.0

tool

linea collections

useful information



| | | | | |
|-------------------|-------|-----|-----|---------|
| 30x60 . 12"x24" | 8,5mm | NR | R10 | MG-2095 |
| 60x60 . 24"x24" | 8,5mm | NR | R10 | MG-2765 |
| | 8,5mm | TC | - | MG-2765 |
| | 9,5mm | NR | R10 | MG-3960 |
| 90x90 . 36"x36" | 9,5mm | TC | - | MG-3960 |
| | 9,5mm | A | - | MG-4290 |
| | 9,5mm | ASR | R11 | MG-3960 |
| | 9,5mm | NR | R10 | MG-4695 |
| 60x120 . 24"x48" | 9,5mm | TC | - | MG-4695 |
| | 9,5mm | A | - | MG-4970 |
| | 9,5mm | ASR | R11 | MG-4695 |
| 120x120 . 48"x48" | 9mm | NR | R10 | MG-5450 |

| | | | | |
|------------------|-------|----|-----|---------|
| 90x90 . 36"x36" | 9,5mm | NR | R10 | MG-3960 |
| 60x120 . 24"x48" | 9,5mm | NR | R10 | MG-4695 |

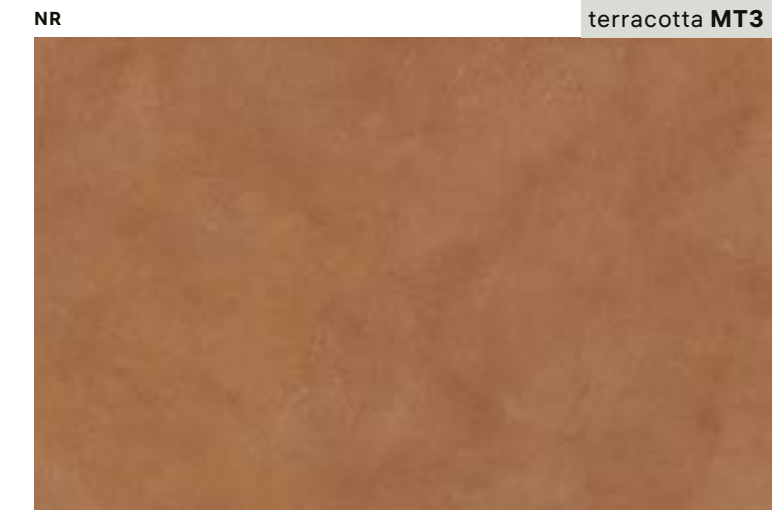

| | | | | |
|-------------------|-------|-----|-----|---------|
| 30x60 . 12"x24" | 8,5mm | NR | R10 | MG-2095 |
| 60x60 . 24"x24" | 8,5mm | NR | R10 | MG-2765 |
| | 8,5mm | TC | - | MG-2765 |
| | 9,5mm | NR | R10 | MG-3960 |
| 90x90 . 36"x36" | 9,5mm | TC | - | MG-3960 |
| | 9,5mm | A | - | MG-4290 |
| | 9,5mm | ASR | R11 | MG-3960 |
| | 9,5mm | NR | R10 | MG-4695 |
| 60x120 . 24"x48" | 9,5mm | TC | - | MG-4695 |
| | 9,5mm | A | - | MG-4970 |
| | 9,5mm | ASR | R11 | MG-4695 |
| 120x120 . 48"x48" | 9mm | NR | R10 | MG-5450 |

| | | | | |
|-------------------|-------|-----|-----|---------|
| 30x60 . 12"x24" | 8,5mm | NR | R10 | MG-2095 |
| 60x60 . 24"x24" | 8,5mm | NR | R10 | MG-2765 |
| | 8,5mm | TC | - | MG-2765 |
| | 9,5mm | NR | R10 | MG-3960 |
| 90x90 . 36"x36" | 9,5mm | TC | - | MG-3960 |
| | 9,5mm | A | - | MG-4290 |
| | 9,5mm | ASR | R11 | MG-3960 |
| | 9,5mm | NR | R10 | MG-4695 |
| 60x120 . 24"x48" | 9,5mm | TC | - | MG-4695 |
| | 9,5mm | A | - | MG-4970 |
| | 9,5mm | ASR | R11 | MG-4695 |
| 120x120 . 48"x48" | 9mm | NR | R10 | MG-5450 |



| | | | | |
|-------------------|-------|-----|-----|---------|
| 30x60 . 12"x24" | 8,5mm | NR | R10 | MG-2095 |
| 60x60 . 24"x24" | 8,5mm | NR | R10 | MG-2765 |
| | 8,5mm | TC | - | MG-2765 |
| | 9,5mm | NR | R10 | MG-3960 |
| 90x90 . 36"x36" | 9,5mm | TC | - | MG-3960 |
| | 9,5mm | A | - | MG-4290 |
| | 9,5mm | ASR | R11 | MG-3960 |
| | 9,5mm | NR | R10 | MG-4695 |
| 60x120 . 24"x48" | 9,5mm | TC | - | MG-4695 |
| | 9,5mm | A | - | MG-4970 |
| | 9,5mm | ASR | R11 | MG-4695 |
| 120x120 . 48"x48" | 9mm | NR | R10 | MG-5450 |



PROTECT

Antibacterial for Life.

An exclusive line of extremely high performance antimicrobial floor and wall tiles, designed for healthy, safe and protected living spaces. Available only in natural rectified, touch and soft shiny finishes.
 Une ligne exclusive de sols et revêtements antibactériens aux performances très élevées, pour un habitat sain, sûr et protégé. Uniquement disponible dans les finitions finitions naturel, touch et adouci.
 Eine exklusive Linie an hochwertigen Fußböden und antibakteriellen Wandverkleidungen, für ein gesundes, sicheres und geschütztes Leben. Nur auf rektifiziert naturbelassen, touch und halbpoliert erhältlich.
 Uma linha exclusiva de pavimentos e revestimentos antimicrobianos de altíssima performance, projetada para ambientes saudáveis, seguros e protegidos. Disponível unicamente nos acabamentos natural retificado, touch e amaciado.



decors

décorations . dekorationen . decorações

9,5MM

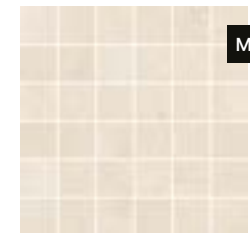

mosaic metropolis 5x5 white
30x30 . 12"x12"
A MG-9745

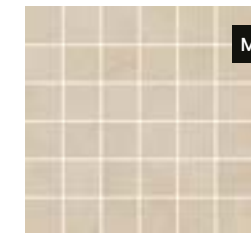

mosaic metropolis 5x5 beige
30x30 . 12"x12"
A MG-9745

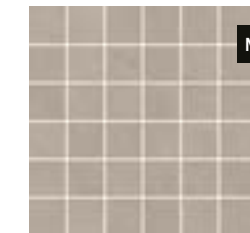

mosaic metropolis 5x5 light grey
30x30 . 12"x12"
A MG-9745

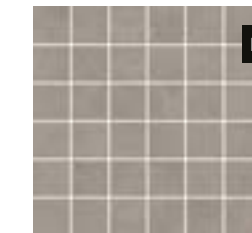

mosaic metropolis 5x5 grey
30x30 . 12"x12"
A MG-9745

listel brushed gold*
1x1x120 . 0,4"x0,4"x47"
MP-6500

listel brushed silver*
1x1x120 . 0,4"x0,4"x47"
MP-6520

listel brushed copper*
1x1x120 . 0,4"x0,4"x47"
MP-6560

Mosaic decors are net mounted. All decors may feature shade variations regarding the corresponding floor/wall tile standard tile.

La décoration Mosaic est sur trame. Toutes les décorations peuvent souffrir variations de tonalité par rapport aux carreaux base.

Die Mosaic Dekoration ist netzverklebt. Alle Dekorationen können im Vergleich zu den jeweiligen Grundiesen Farbunterschiede aufweisen.

A decoração Mosaic é sobre rede. Todas as decorações podem sofrer variações de tonalidade em relação aos respectivos mosaicos base.

*Decorative pieces with precious metals are sensitive to acid attacks. For further information on cleaning metallic decorations – Gold, Silver and Copper – please see section 08 from page 327.

*Les pièces décoratives en métaux précieux sont sensibles aux attaques d'acides. Pour des informations concernant le nettoyage des décors métalliques – Gold, Silver et Copper – veuillez consulter le point 08 à la page 327.

*Dekorative teile mit Edelmetallen sind gegen Säure empfindlich. Informationen zur Reinigung der Metalldekorationen – Gold, Silver und Copper – finden Sie in Punkt 08 auf Seite 327.

*Peças decorativas com metais preciosos são sensíveis aos ataques ácidos. Para informações sobre limpeza das decorações metálicas – Gold, Silver e Copper – por favor consulte o ponto 08 da página 327.

metropolis

collection

metropolis

collection

decors

décorations . dekorationen . decorações

9,5MM



capital white *
30x120
A MP-6415



capital beige *
30x120
A MP-6415

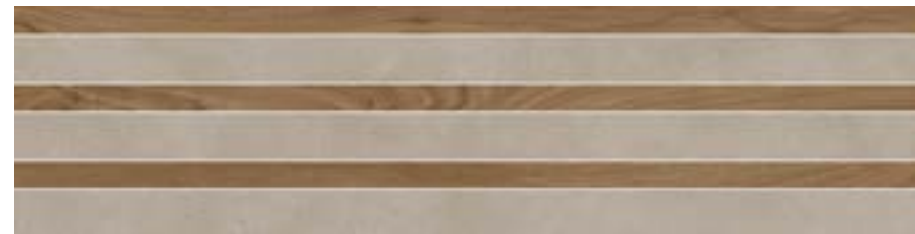

capital light grey **
30x120
A MP-6415

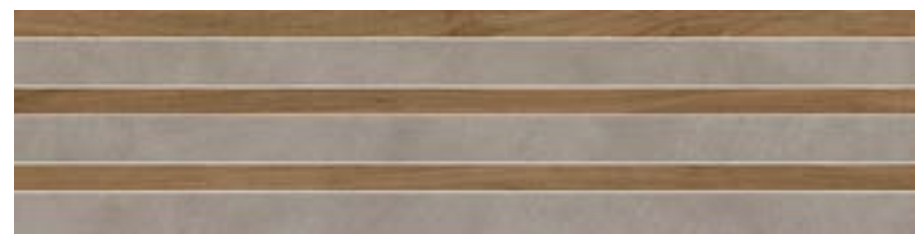

capital grey **
30x120
A MP-6415

* Wood insert: Stage Beige
Insert Bois: Stage Beige
Holzprofil eingefügt: Stage Beige
Inserto de madeira: Stage Beige

** Wood insert: Stage Brown
Insert Bois: Stage Brown
Holzprofil eingefügt: Stage Brown
Inserto de madeira: Stage Brown

Capital decor is net mounted. All decors may feature shade variations regarding the corresponding floor/wall tile standard tile.
La décoration Capital est sur trame. Toutes les décorations peuvent souffrir variations de tonalité par rapport aux carreaux base.
Die Capital Dekoration ist netzverklebt. Alle Dekorationen können im Vergleich zu den jeweiligen Grundiesen Farbunterschiede aufweisen.
A decoração Capital é sobre rede. Todas as decorações podem sofrer variações de tonalidade em relação aos respectivos mosaicos base.

special pieces

pièces spéciales . spezialteile . peças especiais

9,5 . 8,5MM

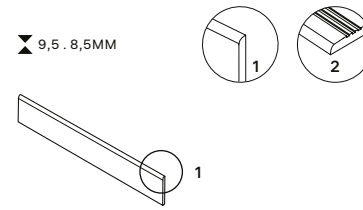

skirting
plinthe
sockel
rodapé boleado
8x60
NR . TC MP-6170
8x90
NR . TC MP-6260
A MP-6270
8x120
NR . TC MP-6260
A MP-6270

step tread grooved
nez de marche creusé
stufenplatte mit rillen
degrau sulcado
30x60
NR . TC MP-6240
30x90
NR . TC . ASR MP-6430
A MP-6445
30x120
NR . TC . ASR MP-6445
A MP-6470

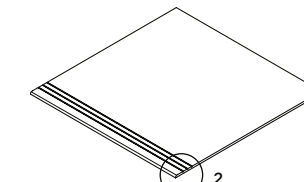

step tread grooved
nez de marche creusé
stufenplatte mit rillen
degrau sulcado
60x60
NR . TC MP-6400

9,5 . 8,5MM

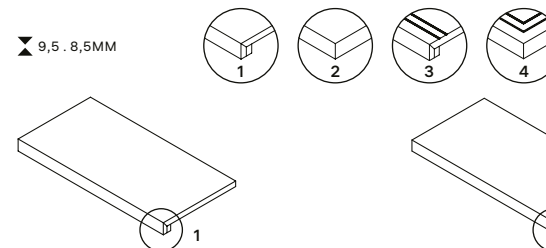

step extra thick
nez de marche forte épaisseur
massive stufenplatte
degrau espessurado
30x60
NR . TC MP-6560
30x90
NR . TC . A . ASR MP-6590
30x120
NR . TC . A . ASR MP-6595

step extra thick corner*
nez de marche forte épaisseur angle*
ecke massive stufenplatte*
degrau espessurado canto*
30x60
NR . TC MP-6630
30x90
NR . TC . A . ASR MP-6645
30x120
NR . TC . A . ASR MP-6655

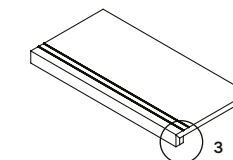

step extra thick inox
nez de marche forte épaisseur inox
massive stufenplatte inox
degrau espessurado inox
30x60
NR . TC MP-6580
30x90
NR . TC . A MP-6640
30x120
NR . TC . A MP-6670

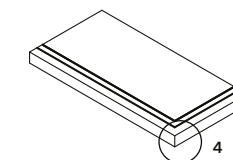

step extra thick corner inox*
nez de marche forte épaisseur angle inox*
ecke massive stufenplatte inox*
degrau espessurado canto inox*
30x60
NR . TC MP-6650
30x90
NR . TC . A MP-6690
30x120
NR . TC . A MP-6710

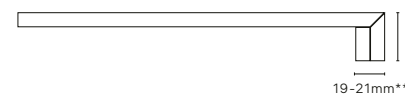

step extra thick corner . nez de marche forte épaisseur angle
ecke massive stufenplatte . degrau espessurado canto

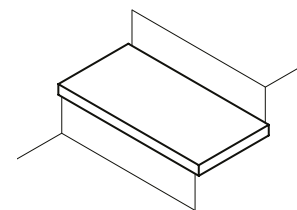

right corner . angle droit
rechten ecke . canto direito

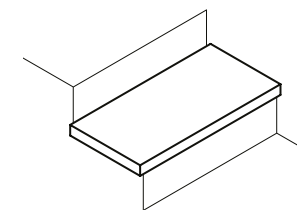

left corner . angle gauche
links ecke . canto esquerdo



step extra thick corner inox . nez de marche forte épaisseur angle inox
ecke massive stufenplatte inox . degrau espessurado canto inox

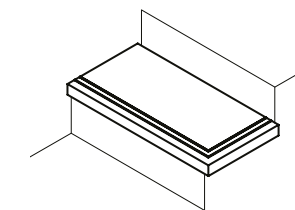

right corner . angle droit
rechten ecke . canto direito

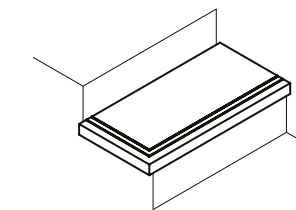

left corner . angle gauche
links ecke . canto esquerdo

Available in all colours
Disponible dans toutes les couleurs
Erhältlich in allen Farben
Disponível em todas as cores

Terracotta colour is only available in the Natural Rectified finish and sizes 30x90, 30x120, 8x90 and 8x120.
La couleur Terracotta est disponible uniquement en finition Naturel Rectifié et dans les formats 30x90, 30x120, 8x90 et 8x120.
Die Farbe Terracotta ist nur in der natural rektifizierte Oberfläche und in den Formaten 30x90, 30x120, 8x90 und 8x120 erhältlich.
A cor Terracotta está disponível unicamente no acabamento Natural Retificado e nos formatos 30x90, 30x120, 8x90 e 8x120.

*Available in right and left corner
*Disponible dans les coin droit et gauche
*Erhältlich in der rechten Ecke und links
*Disponível no canto direito e esquerdo

MARGRES
CERAMIC TILES

index

colour map

collections

concept

endless

evoke

grove

hybrid

jungle

metropolis

natural

prestige

pure stone

slabstone

stage

subway

tecnica

time 2.0

tool

linea collections

useful information



beige SE2 20X120 A

DIGITEK
PORCELAIN
STONEWARE

stage

collection

↓
DOWNLOAD
CATALOGUE

↓
DOWNLOAD
TECHNICAL
FEATURES

🌐
VIEW
ONLINE



60x120
A 9,5mm



20x120
NR 9,5mm
A 9,5mm



cream
SE1

beige
SE2

cherry
SE4

brown
SE5

UGL **V2** **R10** 
NR

PROTECT

Antibacterial for Life.

MARGRES
CERAMIC TILES

index

colour map

collections

concept

endless

evoke

grove

hybrid

jungle

metropolis

natural

prestige

pure stone

slabstone

stage

subway

tecnica

time 2.0

tool

linea collections

useful information

stage
collection



44

general catalogue, 2024

cream SE1 20X120 A

stage
collection

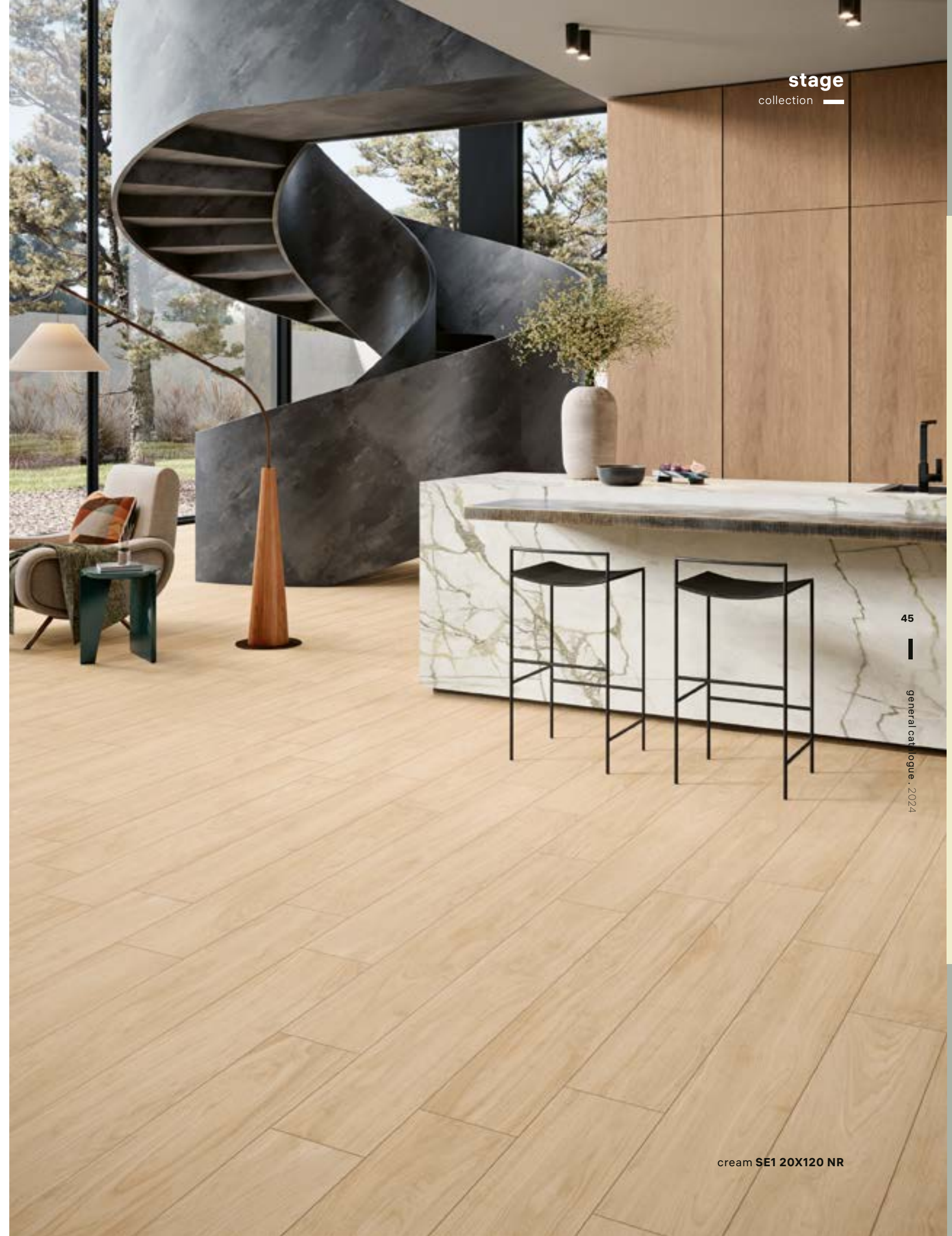

45

general catalogue, 2024

cream SE1 20X120 NR

index

colour map

collections

concept

endless

evoke

grove

hybrid

jungle

metropolis

natural

prestige

pure stone

slabstone

stage

subway

tecnica

time 2.0

tool

linea collections

useful information

stage
— collection



cherry SE4 20x120 NR



stage
— collection

chevron cherry 20X120 A

index

colour map

collections

concept

endless

evoke

grove

hybrid

jungle

metropolis

natural

prestige

pure stone

slabstone

stage

subway

tecnica

time 2.0

tool

linea collections

useful information



stage
— collection

stage
— collection

STAGEWOOD
AUDITORIUM

50

51

general catalogue . 2024

general catalogue . 2024

index

colour map

collections

concept

endless

evoke

grove

hybrid

jungle

metropolis

natural

prestige

pure stone

slabstone

stage

subway

tecnica

time 2.0

tool

linea collections

useful information

brown SE5 60X120 A



| | | | | |
|------------------|-------|----|-----|---------|
| 20x120 . 8"x48" | 9,5mm | NR | R10 | MG-1330 |
| | 9,5mm | A | - | MG-1450 |
| 60x120 . 24"x48" | 9,5mm | A | - | MG-4950 |



| | | | | |
|------------------|-------|----|-----|---------|
| 20x120 . 8"x48" | 9,5mm | NR | R10 | MG-1330 |
| | 9,5mm | A | - | MG-1450 |
| 60x120 . 24"x48" | 9,5mm | A | - | MG-4950 |



| | | | | |
|------------------|-------|----|-----|---------|
| 20x120 . 8"x48" | 9,5mm | NR | R10 | MG-1330 |
| | 9,5mm | A | - | MG-1450 |
| 60x120 . 24"x48" | 9,5mm | A | - | MG-4950 |



| | | | | |
|------------------|-------|----|-----|---------|
| 20x120 . 8"x48" | 9,5mm | NR | R10 | MG-1330 |
| | 9,5mm | A | - | MG-1450 |
| 60x120 . 24"x48" | 9,5mm | A | - | MG-4950 |

decors

décorations . dekorationen . decorações

9,5MM



chevron cream
20x100 . 8"x39,4"
NR MG-9525
A MG-9715



taco cream
6,5x40 . 2,6"x15,7"
A MG-9730



chevron beige
20x100 . 8"x39,4"
NR MG-9525
A MG-9715



taco beige
6,5x40 . 2,6"x15,7"
A MG-9730



chevron cherry
20x100 . 8"x39,4"
NR MG-9525
A MG-9715



taco cherry
6,5x40 . 2,6"x15,7"
A MG-9730



chevron brown
20x100 . 8"x39,4"
NR MG-9525
A MG-9715



taco brown
6,5x40 . 2,6"x15,7"
A MG-9730

special pieces

pièces spéciales . spezialteile . peças especiais

9,5MM

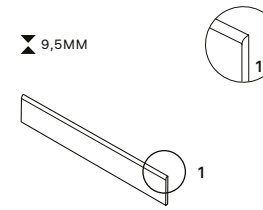

skirting
plinthe
sockel
rodapé boleado
8x120 . 3,2"x48"
NR MP-6260
A MP-6270

9,5MM

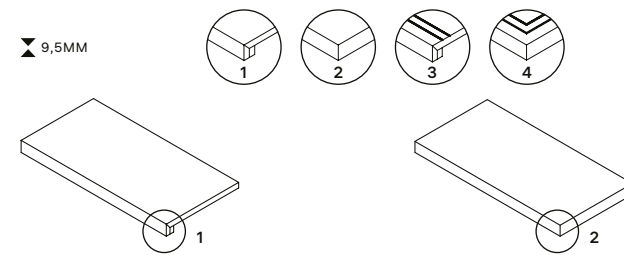

step extra thick
nez de marche forte épaisseur
massive stufenplatte
degrau espessurado
30x120 . 12"x48"
NR . A MP-6595

step extra thick corner*
nez de marche forte épaisseur angle*
ecke massive stufenplatte*
degrau espessurado canto*
30x120 . 12"x48"
NR . A MP-6655

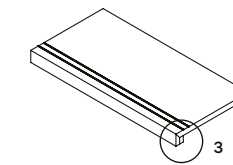

step extra thick inox
nez de marche forte épaisseur inox
massive stufenplatte inox
degrau espessurado inox
30x120 . 12"x48"
NR . A MP-6670

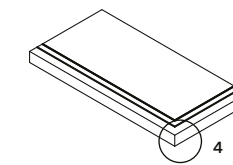

step extra thick corner inox*
nez de marche forte épaisseur angle inox*
ecke massive stufenplatte inox*
degrau espessurado canto inox*
30x120 . 12"x48"
NR . A MP-6710



step extra thick corner . nez de marche forte épaisseur angle
ecke massive stufenplatte . degrau espessurado canto

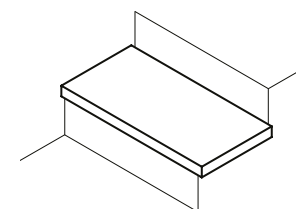

right corner . angle droit
rechten ecke . canto direito

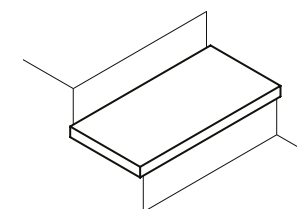

left corner . angle gauche
links ecke . canto esquerdo

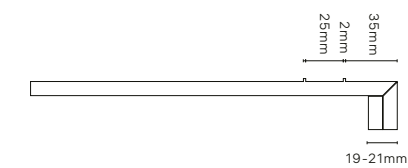

step extra thick corner inox . nez de marche forte épaisseur angle inox
ecke massive stufenplatte inox . degrau espessurado canto inox

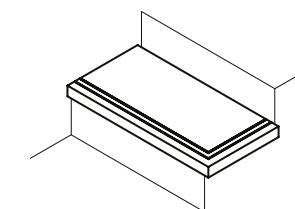

right corner . angle droit
rechten ecke . canto direito

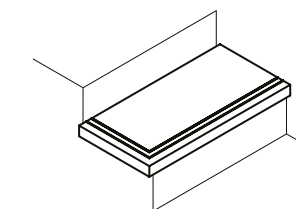

left corner . angle gauche
links ecke . canto esquerdo

Available in all colours
Disponible dans toutes les couleurs
Erhältlich in allen Farben
Disponível em todas as cores

*Available in right and left corner
*Disponible dans les coin droit et gauche
*Erhältlich in der rechten Ecke und links
*Disponível no canto direito e esquerdo



breccia capraia ED2 60x120 P

LAMINATED
PORCELAIN
STONEWARE

DIGITEK
PORCELAIN
STONEWARE

endless

collection



100x300
SM . P 5,5mm



100x250
SM . P 5,5mm

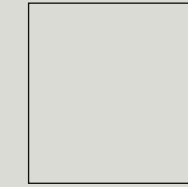

100x100
SM . P 5,5mm



50x100
SM . P 5,5mm



60x120
SM . P 9,5mm

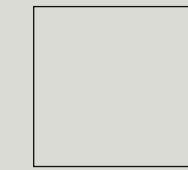

90x90
SM . ASR 9,5mm



89x89
P 9,5mm

↓
DOWNLOAD
CATALOGUE

↓
DOWNLOAD
TECHNICAL
FEATURES

🌐
VIEW
ONLINE

rectified products . produits rectifiés . rektifizierete produkte . produtos retificados



calacatta
gold
ED1 . LED1

breccia
capraia
ED2 . LED2

travertino
ED3 . LED3

port black
ED4 . LED4

amazonite
ED5 . LED5

UGL V2 R10
ASR SM . ASR P

PROTECT

Antibacterial for Life.

MARGRES
CERAMIC TILES

index

colour map

collections

concept

endless

evoke

grove

hybrid

jungle

metropolis

natural

prestige

pure stone

slabstone

stage

subway

tecnica

time 2.0

tool

linea collections

useful information



index

colour map

collections

concept

endless

evoke

grove

hybrid

jungle

metropolis

natural

prestige

pure stone

slabstone

stage

subway

tecnica

time 2.0

tool

linea collections

useful information





62
general catalogue, 2024

calacatta gold ED1 60x120 SM



63
general catalogue, 2024

amazonite ED5 60x120 P

index

colour map

collections

concept

endless

evoke

grove

hybrid

jungle

metropolis

natural

prestige

pure stone

slabstone

stage

subway

tecnica

time 2.0

tool

linea collections

useful information

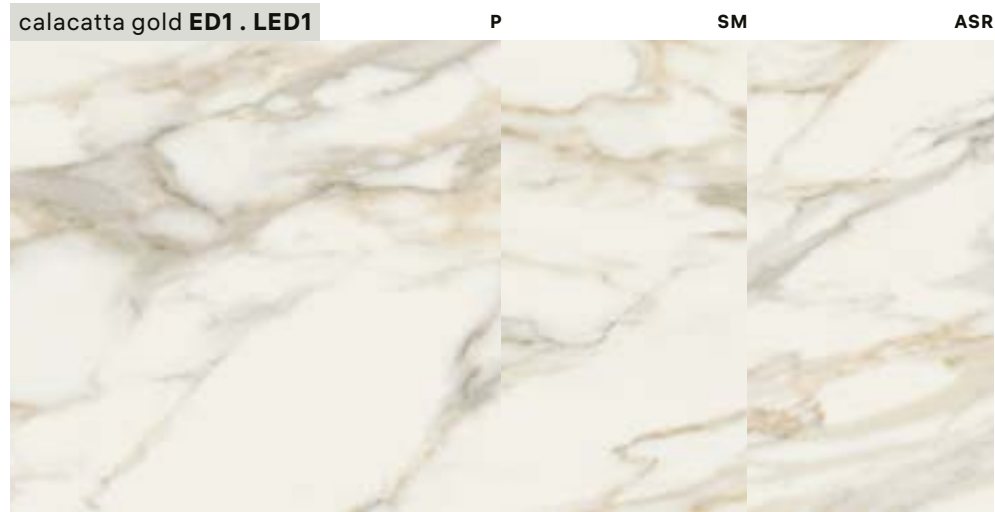

| | | | | |
|-------------------------|-------|------------|-----|---------|
| 89x89 . 35"x35" | 9,5mm | P | - | MG-4470 |
| | 9,5mm | SM | - | MG-3955 |
| 90x90 . 36"x36" | 9,5mm | ASR | R10 | MG-3955 |
| | 9,5mm | SM | - | MG-4680 |
| 60x120 . 24"x48" | 9,5mm | P | - | MG-5160 |

| | | | | |
|------------------------------|-------|-----------|---|---------|
| LINEA | | | | |
| 50x100 . 19,6"x39,4" | 5,5mm | SM | - | M3-1930 |
| | 5,5mm | P | - | M3-2330 |
| 100x100 . 39,4"x39,4" | 5,5mm | SM | - | M3-2730 |
| | 5,5mm | P | - | M3-3130 |
| 100x250 . 39,4"x98,4" | 5,5mm | SM | - | M3-3530 |
| | 5,5mm | P | - | M3-3830 |
| 100x300 . 39,4"x118" | 5,5mm | SM | - | M3-4230 |
| | 5,5mm | P | - | M3-4630 |



| | | | | |
|-------------------------|-------|------------|-----|---------|
| 89x89 . 35"x35" | 9,5mm | P | - | MG-4470 |
| | 9,5mm | SM | - | MG-3955 |
| 90x90 . 36"x36" | 9,5mm | ASR | R10 | MG-3955 |
| | 9,5mm | SM | - | MG-4680 |
| 60x120 . 24"x48" | 9,5mm | P | - | MG-5160 |

| | | | | |
|------------------------------|-------|-----------|---|---------|
| LINEA | | | | |
| 50x100 . 19,6"x39,4" | 5,5mm | SM | - | M3-1930 |
| | 5,5mm | P | - | M3-2330 |
| 100x100 . 39,4"x39,4" | 5,5mm | SM | - | M3-2730 |
| | 5,5mm | P | - | M3-3130 |
| 100x250 . 39,4"x98,4" | 5,5mm | SM | - | M3-3530 |
| | 5,5mm | P | - | M3-3830 |
| 100x300 . 39,4"x118" | 5,5mm | SM | - | M3-4230 |
| | 5,5mm | P | - | M3-4630 |

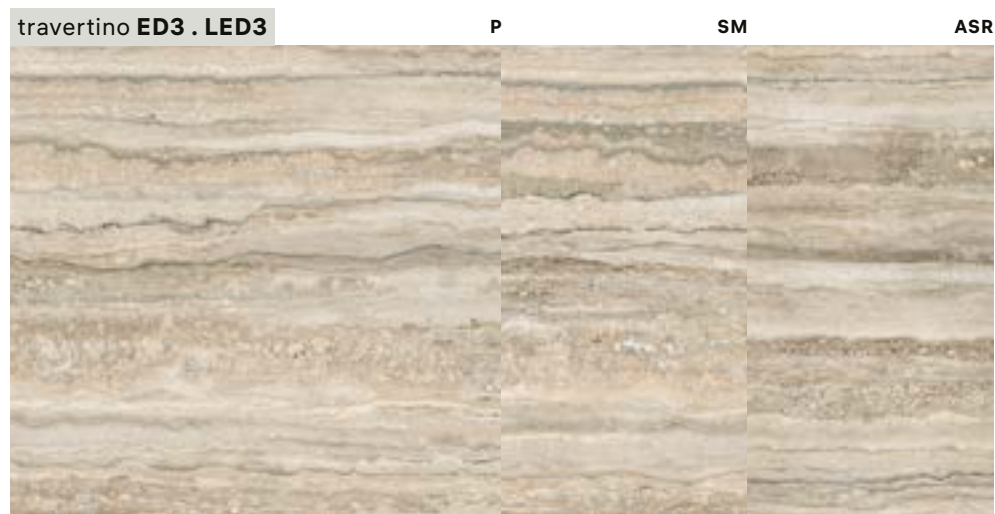

| | | | | |
|-------------------------|-------|------------|-----|---------|
| 89x89 . 35"x35" | 9,5mm | P | - | MG-4470 |
| | 9,5mm | SM | - | MG-3955 |
| 90x90 . 36"x36" | 9,5mm | ASR | R10 | MG-3955 |
| | 9,5mm | SM | - | MG-4680 |
| 60x120 . 24"x48" | 9,5mm | P | - | MG-5160 |

| | | | | |
|------------------------------|-------|-----------|---|---------|
| LINEA | | | | |
| 50x100 . 19,6"x39,4" | 5,5mm | SM | - | M3-1930 |
| | 5,5mm | P | - | M3-2330 |
| 100x100 . 39,4"x39,4" | 5,5mm | SM | - | M3-2730 |
| | 5,5mm | P | - | M3-3130 |
| 100x250 . 39,4"x98,4" | 5,5mm | SM | - | M3-3530 |
| | 5,5mm | P | - | M3-3830 |
| 100x300 . 39,4"x118" | 5,5mm | SM | - | M3-4230 |
| | 5,5mm | P | - | M3-4630 |

| | | | | |
|-------------------------|-------|----------|---|---------|
| 89x89 . 35"x35" | 9,5mm | P | - | MG-4470 |
| 60x120 . 24"x48" | 9,5mm | P | - | MG-5160 |

| | | | | |
|------------------------------|-------|----------|---|---------|
| LINEA | | | | |
| 50x100 . 19,6"x39,4" | 5,5mm | P | - | M3-2330 |
| 100x100 . 39,4"x39,4" | 5,5mm | P | - | M3-3130 |
| 100x250 . 39,4"x98,4" | 5,5mm | P | - | M3-3830 |
| 100x300 . 39,4"x118" | 5,5mm | P | - | M3-4630 |

| | | | | |
|-------------------------|-------|----------|---|---------|
| 89x89 . 35"x35" | 9,5mm | P | - | MG-4470 |
| 60x120 . 24"x48" | 9,5mm | P | - | MG-5160 |

| | | | | |
|------------------------------|-------|----------|---|---------|
| LINEA | | | | |
| 50x100 . 19,6"x39,4" | 5,5mm | P | - | M3-2330 |
| 100x100 . 39,4"x39,4" | 5,5mm | P | - | M3-3130 |
| 100x250 . 39,4"x98,4" | 5,5mm | P | - | M3-3830 |
| 100x300 . 39,4"x118" | 5,5mm | P | - | M3-4630 |

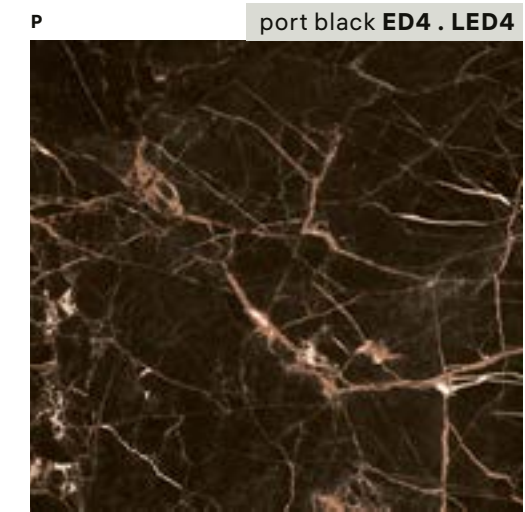

Products with a polished finish are more sensitive to abrasion and stains, what requires special conditions. Please see page 328 in chapter 09.
Les produits à finition polie sont plus sensibles à l'abrasion et aux taches, ce qui requiert des conditions particulières. Veuillez-vous consulter la page 328 du chapitre 09.
Produkte mit einer polierten Oberfläche sind empfindlicher gegen Abrieb und Fleckenbildung, was besondere Bedingungen erfordert. Bitte beachten Sie Seite 328 in Kapitel 09.
Os produtos com acabamento polido são mais sensíveis à abrasão e às manchas, o que requer condições especiais. Por favor consulte a página 328 no capítulo 09.

PROTECT

Antibacterial for Life.

An exclusive line of extremely high performance antimicrobial floor and wall tiles, designed for healthy, safe and protected living spaces. Available only in smooth and polished finishes.
Une ligne exclusive de sols et revêtements antibactériens aux performances très élevées, pour un habitat sain, sûr et protégé. Uniquement disponible dans les finitions smooth et poli.
Eine exklusive Linie an hochwertigen Fußböden und antibakteriellen Wandverkleidungen, für ein gesundes, sicheres und geschütztes Leben. Nur auf smooth und poliert erhältlich.
Uma linha exclusiva de pavimentos e revestimentos antimicrobianos de altíssima performance, projetada para ambientes saudáveis, seguros e protegidos. Disponível unicamente nos acabamentos smooth e polido.

endless
collection

decors

décorations . dekorationen . decorações

9,5MM

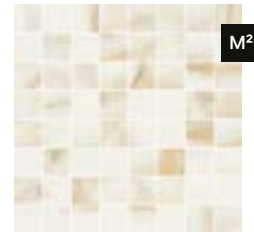

mosaic endless 3,5x3,5
calacatta gold
30x30 . 12"x12"
SM MG-9580
P MG-9830



mosaic endless 3,5x3,5
breccia capraia
30x30 . 12"x12"
SM MG-9580
P MG-9830

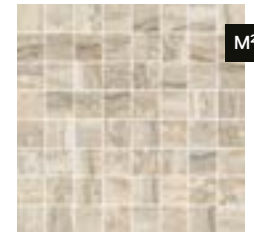

mosaic endless 3,5x3,5
travertino
30x30 . 12"x12"
SM MG-9580
P MG-9830

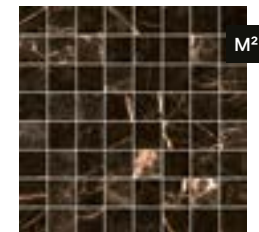

mosaic endless 3,5x3,5
port black
30x30 . 12"x12"
P MG-9830

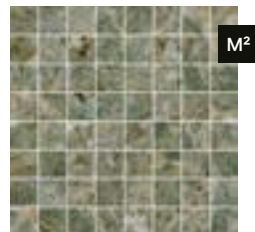

mosaic endless 3,5x3,5
amazonite
30x30 . 12"x12"
P MG-9830

endless
collection

special pieces

pièces spéciales . spezialteile . peças especiais

9,5 MM

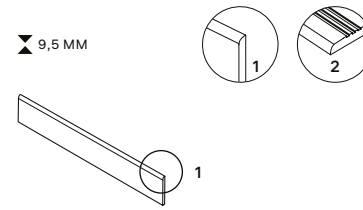

skirting
plinthe
sockel
rodapé boleado

8x89 . 3,2"x35"
P MP-6270
8x90 . 3,2"x36"
SM MP-6260
8x120 . 3,2"x48"
SM MP-6260
P MP-6270

step tread grooved
nez de marche creusé
stufenplatte mit rillen
degrau sulcado

30x89 . 12"x35"
P MP-6445
30x90 . 12"x36"
SM . ASR MP-6430
30x120 . 12"x48"
SM MP-6445
P MP-6470

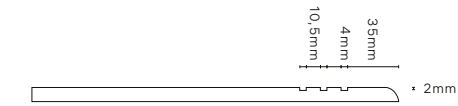

9,5 MM

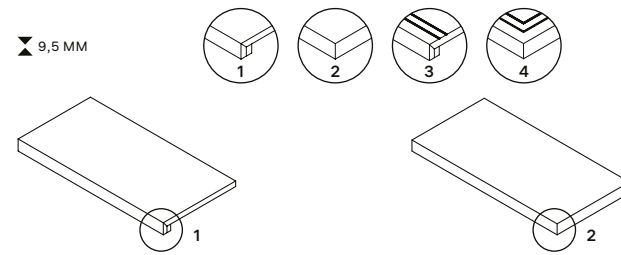

step extra thick
nez de marche forte épaisseur
massive stufenplatte
degrau espessurado

30x89 . 12"x35"
P MP-6590
30x90 . 12"x36"
SM . ASR MP-6590
30x120 . 12"x48"
SM . P MP-6595

step extra thick corner*
nez de marche forte épaisseur angle*
ecke massive stufenplatte*
degrau espessurado canto*

30x89 . 12"x35"
P MP-6650
30x90 . 12"x36"
SM . ASR MP-6645
30x120 . 12"x48"
SM . P MP-6655

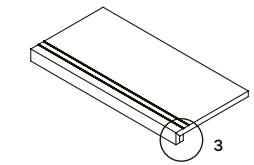

step extra thick inox
nez de marche forte épaisseur inox
massive stufenplatte inox
degrau espessurado inox

30x89 . 12"x35"
P MP-6640
30x90 . 12"x36"
SM MP-6640
30x120 . 12"x48"
SM . P MP-6670

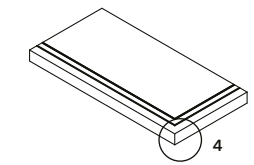

step extra thick corner inox*
nez de marche forte épaisseur angle inox*
ecke massive stufenplatte inox*
degrau espessurado canto inox*

30x89 . 12"x35"
P MP-6690
30x90 . 12"x36"
SM MP-6690
30x120 . 12"x48"
SM . P MP-6710

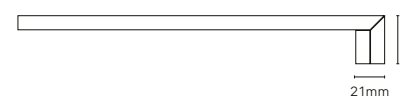

step extra thick corner . nez de marche forte épaisseur angle
ecke massive stufenplatte . degrau espessurado canto

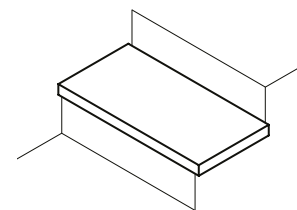

right corner . angle droit
rechten ecke . canto direito

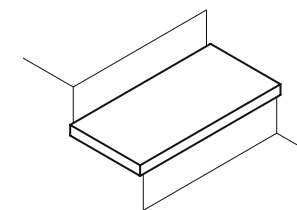

left corner . angle gauche
links ecke . canto esquerdo



step extra thick corner inox . nez de marche forte épaisseur angle inox
ecke massive stufenplatte inox . degrau espessurado canto inox

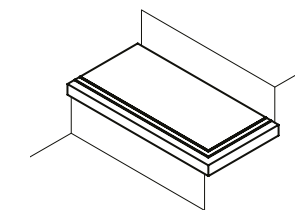

right corner . angle droit
rechten ecke . canto direito

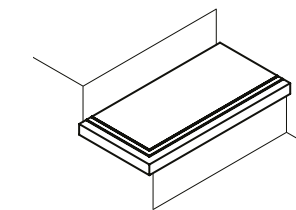

left corner . angle gauche
links ecke . canto esquerdo

Available in all colours
Disponible dans toutes les couleurs
Erhältlich in allen Farben
Disponível em todas as cores

*Available in right and left corner
*Disponible dans les coin droit et gauche
*Erhältlich in der rechten Ecke und links
*Disponível no canto direito e esquerdo

Mosaic decors are net mounted. All decors may feature shade variations regarding the corresponding floor/wall tile standard tile.
Les décorations Mosaic sont sur trame. Toutes les décorations peuvent souffrir variations de tonalité par rapport aux carreaux base.
Die Mosaic Dekoration liegen auf einem Netz. Alle Dekorationen können im Vergleich zu den jeweiligen Grundiesen Farbunterschiede aufweisen.
As decorações Mosaic são sobre rede. Todas as decorações podem sofrer variações de tonalidade em relação aos respectivos mosaicos base.

index

colour map

collections

concept

endless

evoke

grove

hybrid

jungle

metropolis

natural

prestige

pure stone

slabstone

stage

subway

tecnica

time 2.0

tool

linea collections

useful information









grey PS4 120x120 NR



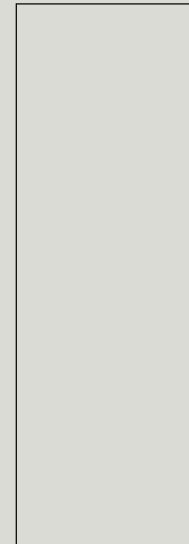

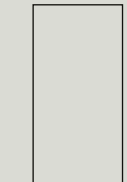
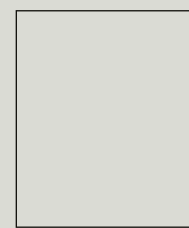
LAMINATED
PORCELAIN
STONEWARE

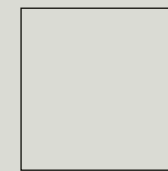
FULL BODY
PORCELAIN

pure stone

collection

| | | | | |
|---|---|---|---|---|
|  |  |  |  | |
| 100x300 NR 6mm | 100x250 NR 6mm | 100x100 NR 6mm | 50x100 NR 6mm | |
|  |  |  |  |  |
| 120x120 NR . A 9,0mm | 60x120 NR . A 9,5mm ASR 9,5mm E ASR 20mm | 90x90 NR . A 9,5mm ASR 9,5mm | 60x60 NR . A 8,5mm ASR 8,5mm | 30x60 NR . A 8,5mm |

-  DOWNLOAD CATALOGUE
-  DOWNLOAD TECHNICAL FEATURES
-  VIEW ONLINE
-  DOWNLOAD CATALOGUE OUTDOOR EXTRA THICK
-  DOWNLOAD BIM

rectified products . produits rectifiés . rektifizierete produkte . produtos retificados

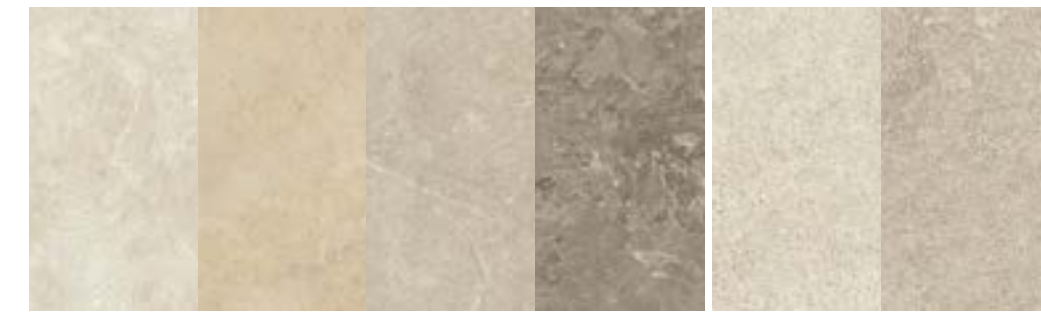

white PS1 . LPS1 beige PS2 . LPS2 light grey PS3 . LPS3 grey PS4 . LPS4 forge white LPS1F forge light grey LPS3F

UGL V2 R11 R10 R9
ASR FORGE LINEA
NR NR NR



PROTECT®
Antibacterial for Life.

pour plus d'informations, consultez
<https://evaluation.cstb.fr>

MARGRES
CERAMIC TILES

index

colour map

collections

- concept
- endless
- evoke
- grove
- hybrid
- jungle
- metropolis
- natural
- prestige
- pure stone**
- slabstone
- stage
- subway
- tecnica
- time 2.0
- tool

linea collections

useful information

pure stone
collection

pure stone
collection

index

colour map

collections

concept

endless

evoke

grove

hybrid

jungle

metropolis

natural

prestige

pure stone

slabstone

stage

subway

tecnica

time 2.0

tool

linea collections

useful information

70

general catalogue . 2024

71

general catalogue . 2024

white PS1 120x120 NR

concept

endless

evoke

grove

hybrid

jungle

metropolis

natural

prestige

pure stone

slabstone

stage

subway

tecnica

time 2.0

tool

linea collections

useful information





74

general catalogue . 2024

75

general catalogue . 2024



white PS1 90x90 NR . grey PS4 NR . listel brushed gold 1x120



light grey PS3 60x120 A . 60x60 A . listel brushed copper 1x120



pure stone
collection



chevron grey 48x64 A



pure stone
collection

beige PS2 90x90 A

index

colour map

collections

concept

endless

evoke

grove

hybrid

jungle

metropolis

natural

prestige

pure stone

slabstone

stage

subway

tecnica

time 2.0

tool

linea collections

useful information

concept

endless

evoke

grove

hybrid

jungle

metropolis

natural

prestige

pure stone

slabstone

stage

subway

tecnica

time 2.0

tool

linea collections

useful information



pure stone
collection

pure stone
collection

index

colour map

collections

concept

endless

evoke

grove

hybrid

jungle

metropolis

natural

prestige

pure stone

slabstone

stage

subway

tecnica

time 2.0

tool

linea collections

useful information

84

general catalogue . 2024

85

general catalogue . 2024

grey PS4 60x120 NR . 60x120 ASR . 60x120 E ASR

pure stone
collection

white **PS1 . LPS1** A NR ASR E ASR



| | | | | |
|--------------------------|-------|--------------|-----|---------|
| 30x60 . 12"x24" | 8,5mm | NR | R10 | MG-2095 |
| | 8,5mm | A | - | MG-2370 |
| 60x60 . 24"x24" | 8,5mm | NR | R10 | MG-2765 |
| | 8,5mm | A | - | MG-3080 |
| | 8,5mm | ASR | R11 | MG-2765 |
| 90x90 . 36"x36" | 9,5mm | NR | R10 | MG-3960 |
| | 9,5mm | A | - | MG-4290 |
| | 9,5mm | ASR | R11 | MG-3960 |
| 60x120 . 24"x48" | 9,5mm | NR | R10 | MG-4695 |
| | 9,5mm | A | - | MG-4970 |
| | 9,5mm | ASR | R11 | MG-4695 |
| | 20mm | E ASR | R11 | MG-7490 |
| 120x120 . 48"x48" | 9mm | NR | R10 | MG-5450 |
| | 9mm | A | - | MG-5700 |

LINEA

| | | | | |
|------------------------------|-----|-----------|----|---------|
| 50x100 . 19,6"x39,4" | 6mm | NR | R9 | M3-5230 |
| 100x100 . 39,4"x39,4" | 6mm | NR | R9 | M3-6230 |
| 100x250 . 39,4"x98,4" | 6mm | NR | R9 | M3-7300 |
| 100x300 . 39,4"x118" | 6mm | NR | R9 | M3-7730 |

beige **PS2 . LPS2** A NR ASR E ASR



| | | | | |
|--------------------------|-------|--------------|-----|---------|
| 30x60 . 12"x24" | 8,5mm | NR | R10 | MG-2095 |
| | 8,5mm | A | - | MG-2370 |
| 60x60 . 24"x24" | 8,5mm | NR | R10 | MG-2765 |
| | 8,5mm | A | - | MG-3080 |
| | 8,5mm | ASR | R11 | MG-2765 |
| 90x90 . 36"x36" | 9,5mm | NR | R10 | MG-3960 |
| | 9,5mm | A | - | MG-4290 |
| | 9,5mm | ASR | R11 | MG-3960 |
| 60x120 . 24"x48" | 9,5mm | NR | R10 | MG-4695 |
| | 9,5mm | A | - | MG-4970 |
| | 9,5mm | ASR | R11 | MG-4695 |
| | 20mm | E ASR | R11 | MG-7490 |
| 120x120 . 48"x48" | 9mm | NR | R10 | MG-5450 |
| | 9mm | A | - | MG-5700 |

LINEA

| | | | | |
|------------------------------|-----|-----------|----|---------|
| 50x100 . 19,6"x39,4" | 6mm | NR | R9 | M3-5230 |
| 100x100 . 39,4"x39,4" | 6mm | NR | R9 | M3-6230 |
| 100x250 . 39,4"x98,4" | 6mm | NR | R9 | M3-7300 |
| 100x300 . 39,4"x118" | 6mm | NR | R9 | M3-7730 |

light grey **PS3 . LPS3** A NR ASR E ASR



| | | | | |
|--------------------------|-------|--------------|-----|---------|
| 30x60 . 12"x24" | 8,5mm | NR | R10 | MG-2095 |
| | 8,5mm | A | - | MG-2370 |
| 60x60 . 24"x24" | 8,5mm | NR | R10 | MG-2765 |
| | 8,5mm | A | - | MG-3080 |
| | 8,5mm | ASR | R11 | MG-2765 |
| 90x90 . 36"x36" | 9,5mm | NR | R10 | MG-3960 |
| | 9,5mm | A | - | MG-4290 |
| | 9,5mm | ASR | R11 | MG-3960 |
| 60x120 . 24"x48" | 9,5mm | NR | R10 | MG-4695 |
| | 9,5mm | A | - | MG-4970 |
| | 9,5mm | ASR | R11 | MG-4695 |
| | 20mm | E ASR | R11 | MG-7490 |
| 120x120 . 48"x48" | 9mm | NR | R10 | MG-5450 |
| | 9mm | A | - | MG-5700 |

LINEA

| | | | | |
|------------------------------|-----|-----------|----|---------|
| 50x100 . 19,6"x39,4" | 6mm | NR | R9 | M3-5230 |
| 100x100 . 39,4"x39,4" | 6mm | NR | R9 | M3-6230 |
| 100x250 . 39,4"x98,4" | 6mm | NR | R9 | M3-7300 |
| 100x300 . 39,4"x118" | 6mm | NR | R9 | M3-7730 |

pure stone
collection

E ASR ASR NR A grey **PS4 . LPS4**

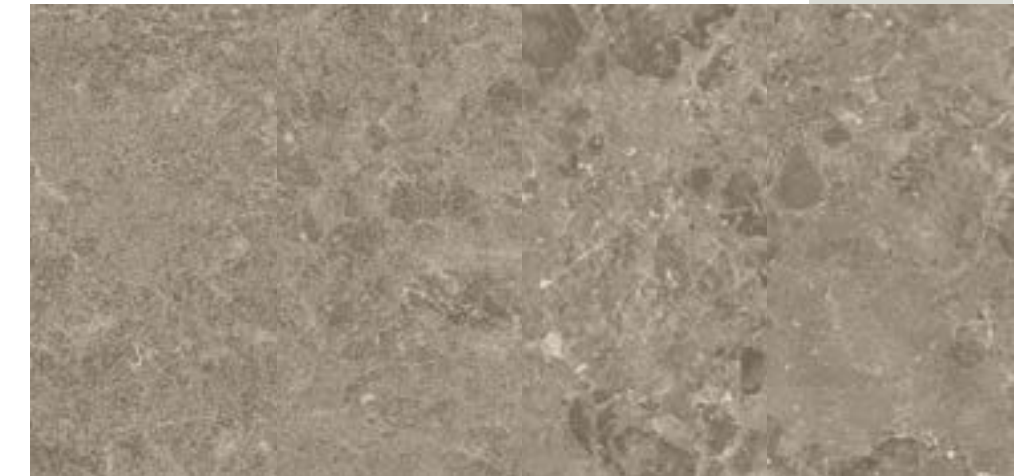

| | | | | |
|--------------------------|-------|--------------|-----|---------|
| 30x60 . 12"x24" | 8,5mm | NR | R10 | MG-2095 |
| | 8,5mm | A | - | MG-2370 |
| 60x60 . 24"x24" | 8,5mm | NR | R10 | MG-2765 |
| | 8,5mm | A | - | MG-3080 |
| | 8,5mm | ASR | R11 | MG-2765 |
| 90x90 . 36"x36" | 9,5mm | NR | R10 | MG-3960 |
| | 9,5mm | A | - | MG-4290 |
| | 9,5mm | ASR | R11 | MG-3960 |
| 60x120 . 24"x48" | 9,5mm | NR | R10 | MG-4695 |
| | 9,5mm | A | - | MG-4970 |
| | 9,5mm | ASR | R11 | MG-4695 |
| | 20mm | E ASR | R11 | MG-7490 |
| 120x120 . 48"x48" | 9mm | NR | R10 | MG-5450 |
| | 9mm | A | - | MG-5700 |

LINEA

| | | | | |
|------------------------------|-----|-----------|----|---------|
| 50x100 . 19,6"x39,4" | 6mm | NR | R9 | M3-5230 |
| 100x100 . 39,4"x39,4" | 6mm | NR | R9 | M3-6230 |
| 100x250 . 39,4"x98,4" | 6mm | NR | R9 | M3-7300 |
| 100x300 . 39,4"x118" | 6mm | NR | R9 | M3-7730 |

NR forge white **LPS1F**



| | | | | |
|------------------------------|-----|-----------|-----|---------|
| LINEA | | | | |
| 50x100 . 19,6"x39,4" | 6mm | NR | R10 | M3-5230 |
| 100x100 . 39,4"x39,4" | 6mm | NR | R10 | M3-6230 |
| 100x250 . 39,4"x98,4" | 6mm | NR | R10 | M3-7300 |
| 100x300 . 39,4"x118" | 6mm | NR | R10 | M3-7730 |

NR forge light grey **LPS3F**



| | | | | |
|------------------------------|-----|-----------|-----|---------|
| LINEA | | | | |
| 50x100 . 19,6"x39,4" | 6mm | NR | R10 | M3-5230 |
| 100x100 . 39,4"x39,4" | 6mm | NR | R10 | M3-6230 |
| 100x250 . 39,4"x98,4" | 6mm | NR | R10 | M3-7300 |
| 100x300 . 39,4"x118" | 6mm | NR | R10 | M3-7730 |

PROTECT

Antibacterial for Life.

An exclusive line of extremely high performance antimicrobial floor and wall tiles, designed for healthy, safe and protected living spaces. Available only in natural rectified and soft shiny finishes.
 Une ligne exclusive de sols et revêtements antibactériens aux performances très élevées, pour un habitat sain, sûr et protégé. Uniquement disponible dans les finitions finitions naturel et adouci.
 Eine exklusive Linie an hochwertigen Fußböden und antibakteriellen Wandverkleidungen, für ein gesundes, sicheres und geschütztes Leben. Nur auf rektifiziert naturbelassen und halbpoliert erhältlich.
 Uma linha exclusiva de pavimentos e revestimentos antimicrobianos de altíssima performance, projetada para ambientes saudáveis, seguros e protegidos. Disponível unicamente nos acabamentos natural retificado e amaciado.



decors

décorations . dekorationen . decorações

8,5MM

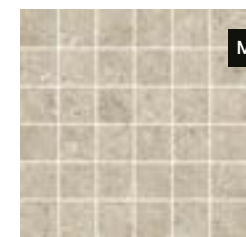

mosaic pure stone 5x5
(all colours)
30x30 . 12"x12"
A MG-9745



bricks pure stone
(all colours)
30x60 . 12"x24"
A MP-6350

8,5MM



mosaic circles pure stone
5x5 white beige
28x31,5 . 11"x12,4"
A MP-6488



mosaic circles pure stone
5x5 white light grey
28x31,5 . 11"x12,4"
A MP-6488



mosaic circles pure stone
5x5 grey
28x31,5 . 11"x12,4"
A MP-6488

listel brushed gold*

1x1x120 . 0,4"x0,4"x47"
MP-6500

listel brushed silver*

1x1x120 . 0,4"x0,4"x47"
MP-6520

listel brushed copper*

1x1x120 . 0,4"x0,4"x47"
MP-6560

*Decorative pieces with precious metals are sensitive to acid attacks. For further information on cleaning metallic decorations – Gold, Silver and Copper – please see section 08 from page 327.

*Les pièces décoratives en métaux précieux sont sensibles aux attaques d'acides. Pour des informations concernant le nettoyage des décors métalliques – Gold, Silver et Copper – veuillez consulter le point 08 à la page 327.

*Dekorative teile mit Edelmetallen sind gegen Säure empfindlich. Informationen zur Reinigung der Metalldekorationen – Gold, Silver und Copper – finden Sie in Punkt 08 auf Seite 327.

*Peças decorativas com metais preciosos são sensíveis aos ataques ácidos. Para informações sobre limpeza das decorações metálicas – Gold, Silver e Copper – por favor consulte o ponto 08 da página 327.

Mosaic and Brick decors are net mounted. All decors may feature shade variations regarding the corresponding floor/wall tile standard tile.

Les décorations Mosaic et Brick sont sur trame. Toutes les décorations peuvent souffrir variations de tonalité par rapport aux carreaux base.

Die Mosaic und Brick Dekoration liegen auf einem Netz. Alle Dekorationen können im Vergleich zu den jeweiligen Grundiesen Farbunterschiede aufweisen.

As decorações Mosaic and Brick são sobre rede. Todas as decorações podem sofrer variações de tonalidade em relação aos respectivos mosaicos base.

pure stone

collection

decors

décorations . dekorationen . decorações

8,5MM



mase pure stone (all colours)

60x60 . 24"x24"

A MG-9720



Example of 4 pieces Mase 60x60 and Insert Pure Stone Silver 10x10 composition.

Exemple de composition avec 4 pièces Mase 60x60 et Insert Pure Stone Silver 10x10.

Ein Beispiel für die Zusammensetzung mit 4 Teilen Mase 60x60 und Insert Pure Stone Silver 10x10.

Exemplo de composição com 4 peças Mase 60x60 e Insert Pure Stone Silver 10x10.



insert pure stone silver*

10x10 . 4"x4"

A MP-6150

9,5MM



chevron pure stone (all colours)

48x64 . 19"x25"

A MG-9735

(sold per two pieces set_ vendu à la paire_ Paarweise verkauft_ vendida ao par)

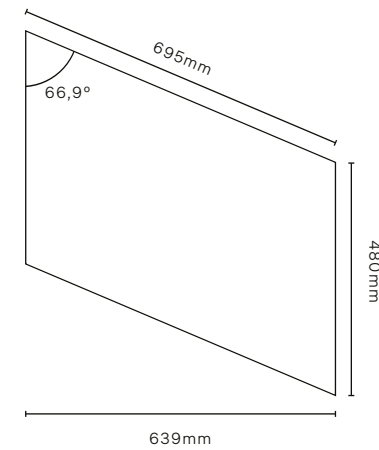

*Decorative pieces with precious metals are sensitive to acid attacks.

*Les pièces décoratives en métaux précieux sont sensibles aux attaques d'acides.

*Dekorative teile mit Edelmetallen sind gegen Säure empfindlich.

*Peças decorativas com metais preciosos são sensíveis aos ataques ácidos.

MARGRES
CERAMIC TILES

special pieces

pièces spéciales . spezialteile . peças especiais

9,5 . 8,5MM

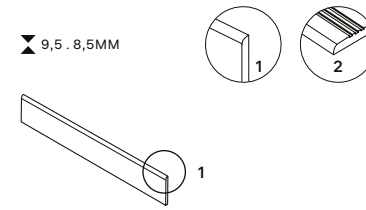

skirting
plinthe
sockel
rodapé boleado

8x60 . 3,2"x24"

NR MP-6170

A MP-6180

8x90 . 3,2"x36"

NR MP-6260

A MP-6270

8x120 . 3,2"x48"

NR MP-6260

A MP-6270

9,5 . 8,5MM

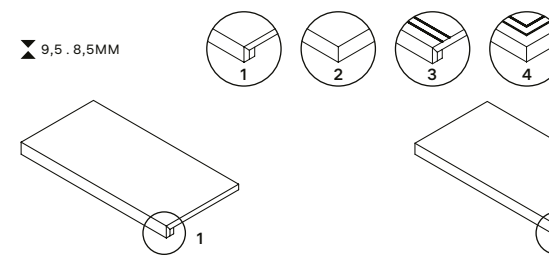

step extra thick
nez de marche forte épaisseur
massive stufenplatte
degrau espessurado

30x60 . 12"x24"

NR . A . ASR MP-6560

30x90 . 12"x36"

NR . A . ASR MP-6590

30x120 . 12"x48"

NR . A . ASR MP-6595

step extra thick corner*
nez de marche forte épaisseur angle*
ecke massive stufenplatte*
degrau espessurado canto*

30x60 . 12"x24"

NR . A . ASR MP-6630

30x90 . 12"x36"

NR . A . ASR MP-6645

30x120 . 12"x48"

NR . A . ASR MP-6655



step extra thick corner . nez de marche forte épaisseur angle
ecke massive stufenplatte . degrau espessurado canto

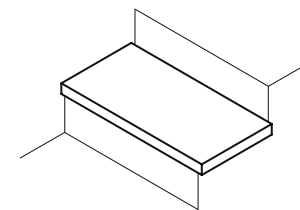

right corner . angle droit
rechten ecke . canto direito

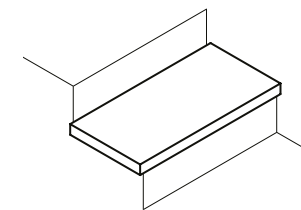

left corner . angle gauche
links ecke . canto esquerdo

Available in all colours

Disponible dans toutes les couleurs

Erhältlich in allen Farben

Disponível em todas as cores

*Available in right and left corner

*Disponible dans les coin droit et gauche

*Erhältlich in der rechten Ecke und links

*Disponível no canto direito e esquerdo

** Dimension will vary depending on the base tile thickness.

** La dimension varie selon l'épaisseur du carreau.

** das Maß variiert je nach Dicke der Fliese.

** A dimensão varia consoante a espessura do material cerâmico.

pure stone

collection

index

colour map

collections

concept

endless

evoke

grove

hybrid

jungle

metropolis

natural

prestige

pure stone

slabstone

stage

subway

tecnica

time 2.0

tool

linea collections

useful information

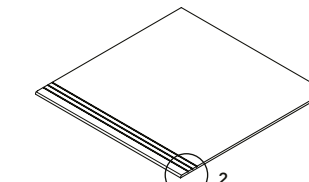
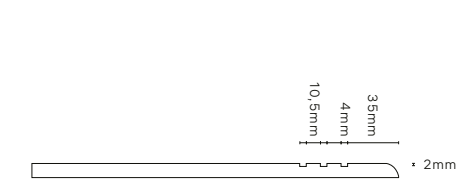

step tread grooved
nez de marche creusé
stufenplatte mit rillen
degrau sulcado

60x60 . 24"x24"

NR . ASR MP-6400

A MP-6430

30x60 . 12"x24"

NR . ASR MP-6430

A MP-6445

30x90 . 12"x36"

NR . ASR MP-6445

A MP-6470

9,5 . 8,5MM

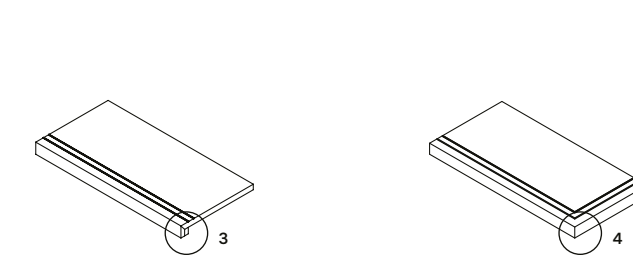

step extra thick inox
nez de marche forte épaisseur inox
massive stufenplatte inox
degrau espessurado inox

30x60 . 12"x24"

NR . A MP-6580

30x90 . 12"x36"

NR . A MP-6640

30x120 . 12"x48"

NR . A MP-6670

step extra thick corner inox*
nez de marche forte épaisseur angle inox*
ecke massive stufenplatte inox*
degrau espessurado canto inox*

30x60 . 12"x24"

NR . A MP-6650

30x90 . 12"x36"

NR . A MP-6690

30x120 . 12"x48"

NR . A MP-6710



step extra thick corner inox . nez de marche forte épaisseur angle inox
ecke massive stufenplatte inox . degrau espessurado canto inox

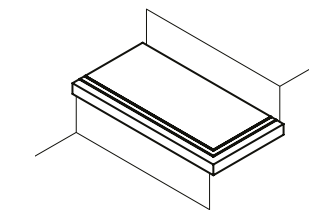

right corner . angle droit
rechten ecke . canto direito

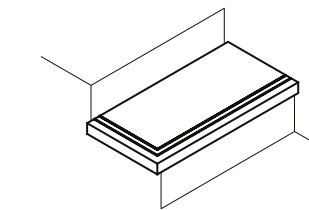

left corner . angle gauche
links ecke . canto esquerdo

OUTDOOR

EXTRA THICK

Special 20MM pieces please refer to page 320.

Pièces spéciales 20MM, veuillez consulter la page 320.

Speziellfertigungen 20MM siehe Seite 320.

Peças especiais 20MM, por favor consulte a página 320.

91

general catalogue . 2024

90

general catalogue . 2024

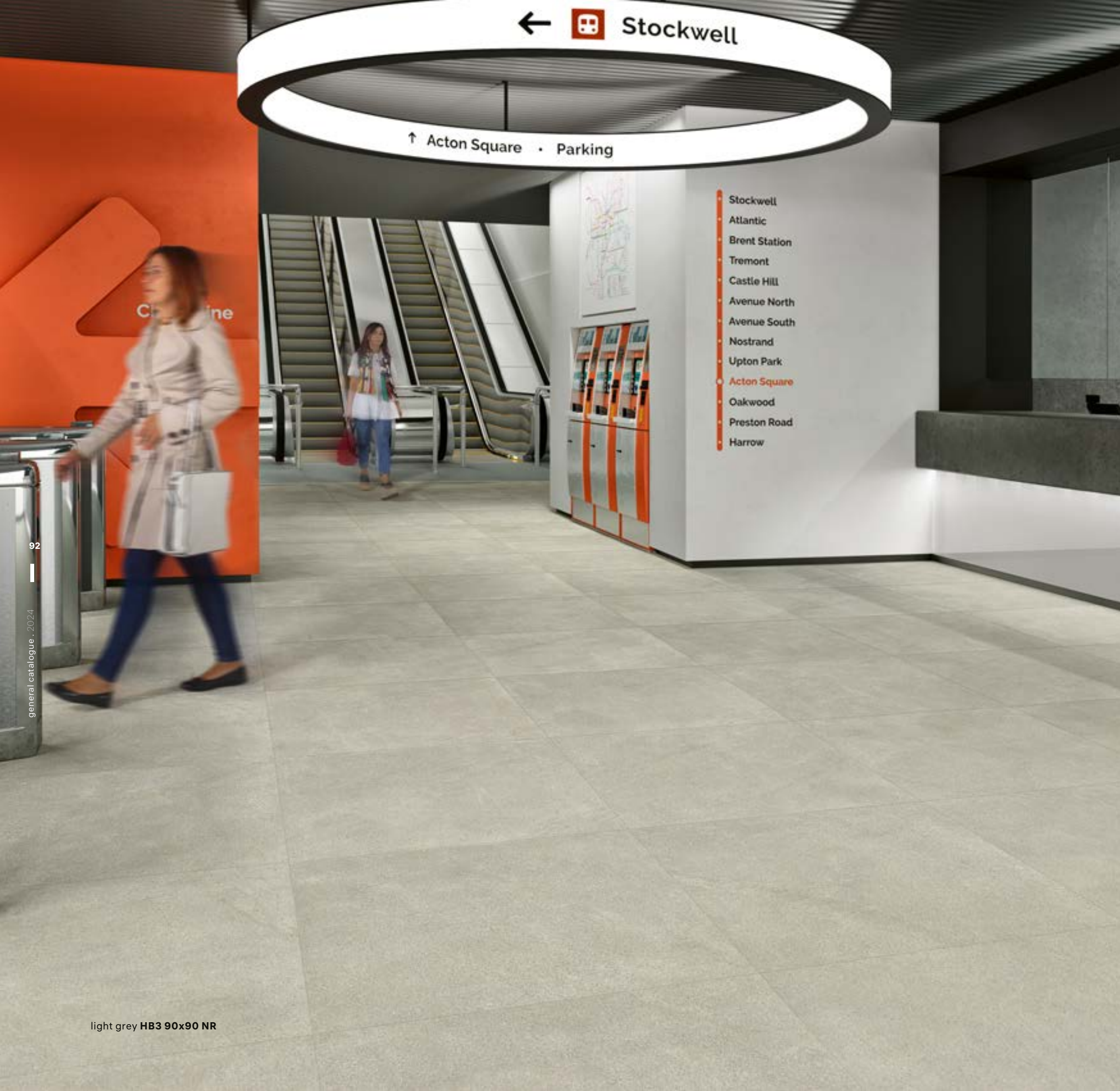





light grey HB3 90x90 NR

TECHNICAL
FULL BODY
PORCELAIN

hybrid
collection

- ↓
DOWNLOAD
CATALOGUE
- ↓
DOWNLOAD
TECHNICAL
FEATURES
- ↓
DOWNLOAD
BIM
- 🌐
VIEW
ONLINE
- ▶
ENJOY THE
VIDEO

| | | | |
|---|---|---|---|
|  |  |  |  |
| 60x120 NR 11mm TC 11mm ASR 11mm | 90x90 NR 11mm TC 11mm ASR 11mm | 60x60 NR 10mm TC 10mm ASR 10mm | 30x60 NR 10mm TC 10mm ASR 10mm |

rectified products . produits rectifiés . rektifizierete produkte . produtos retificados



white HB1 beige HB2 light grey HB3 tortora HB4 black HB5

UGL **V3** **R11** **R10** 
ASR NR



pour plus d'informations, consultez
<https://evaluation.cstb.fr>

MARGRES
CERAMIC TILES

- index —
- colour map —
- collections** —
- concept
- endless
- evoke
- grove
- hybrid** —
- jungle
- metropolis
- natural
- prestige
- pure stone
- slabstone
- stage
- subway
- tecnica
- time 2.0
- tool
- linea collections —
- useful information —





white HB1 60x60 TC



beige HB2 90x90 NR

index

colour map

collections

concept

endless

evoke

grove

hybrid

jungle

metropolis

natural

prestige

pure stone

slabstone

stage

subway

tecnica

time 2.0

tool

linea collections

useful information



hybrid
collection

tortora HB4 60x120 TC



hybrid
collection

tortora HB4 90x90 ASR

index

colour map

collections

concept

endless

evoke

grove

hybrid

jungle

metropolis

natural

prestige

pure stone

slabstone

stage

subway

tecnica

time 2.0

tool

linea collections

useful information



| | | | | |
|------------------|------|-----|-----|---------|
| 30x60 . 12"x24" | 10mm | NR | R10 | MG-2235 |
| | 10mm | TC | - | MG-2235 |
| | 10mm | ASR | R11 | MG-2235 |
| 60x60 . 24"x24" | 10mm | NR | R10 | MG-2890 |
| | 10mm | TC | - | MG-2890 |
| | 10mm | ASR | R11 | MG-2890 |
| 90x90 . 36"x36" | 11mm | NR | R10 | MG-4100 |
| | 11mm | TC | - | MG-4100 |
| | 11mm | ASR | R11 | MG-4100 |
| 60x120 . 24"x48" | 11mm | NR | R10 | MG-4790 |
| | 11mm | TC | - | MG-4790 |
| | 11mm | ASR | R11 | MG-4790 |



| | | | | |
|------------------|------|-----|-----|---------|
| 30x60 . 12"x24" | 10mm | NR | R10 | MG-2125 |
| | 10mm | TC | - | MG-2125 |
| | 10mm | ASR | R11 | MG-2125 |
| 60x60 . 24"x24" | 10mm | NR | R10 | MG-2810 |
| | 10mm | TC | - | MG-2810 |
| | 10mm | ASR | R11 | MG-2810 |
| 90x90 . 36"x36" | 11mm | NR | R10 | MG-4055 |
| | 11mm | TC | - | MG-4055 |
| | 11mm | ASR | R11 | MG-4055 |
| 60x120 . 24"x48" | 11mm | NR | R10 | MG-4720 |
| | 11mm | TC | - | MG-4720 |
| | 11mm | ASR | R11 | MG-4720 |



| | | | | |
|------------------|------|-----|-----|---------|
| 30x60 . 12"x24" | 10mm | NR | R10 | MG-2125 |
| | 10mm | TC | - | MG-2125 |
| | 10mm | ASR | R11 | MG-2125 |
| 60x60 . 24"x24" | 10mm | NR | R10 | MG-2810 |
| | 10mm | TC | - | MG-2810 |
| | 10mm | ASR | R11 | MG-2810 |
| 90x90 . 36"x36" | 11mm | NR | R10 | MG-4055 |
| | 11mm | TC | - | MG-4055 |
| | 11mm | ASR | R11 | MG-4055 |
| 60x120 . 24"x48" | 11mm | NR | R10 | MG-4720 |
| | 11mm | TC | - | MG-4720 |
| | 11mm | ASR | R11 | MG-4720 |

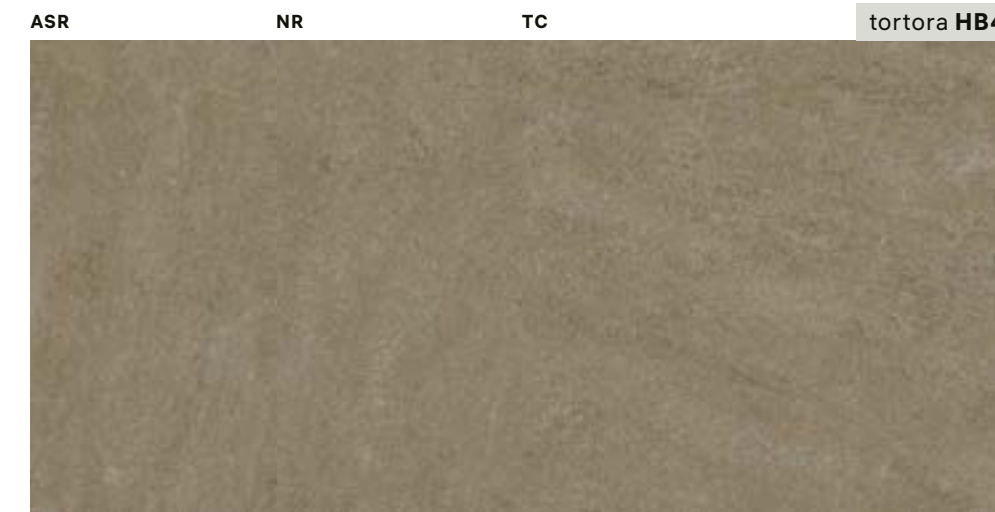

| | | | | |
|------------------|------|-----|-----|---------|
| 30x60 . 12"x24" | 10mm | NR | R10 | MG-2125 |
| | 10mm | TC | - | MG-2125 |
| | 10mm | ASR | R11 | MG-2125 |
| 60x60 . 24"x24" | 10mm | NR | R10 | MG-2810 |
| | 10mm | TC | - | MG-2810 |
| | 10mm | ASR | R11 | MG-2810 |
| 90x90 . 36"x36" | 11mm | NR | R10 | MG-4055 |
| | 11mm | TC | - | MG-4055 |
| | 11mm | ASR | R11 | MG-4055 |
| 60x120 . 24"x48" | 11mm | NR | R10 | MG-4720 |
| | 11mm | TC | - | MG-4720 |
| | 11mm | ASR | R11 | MG-4720 |

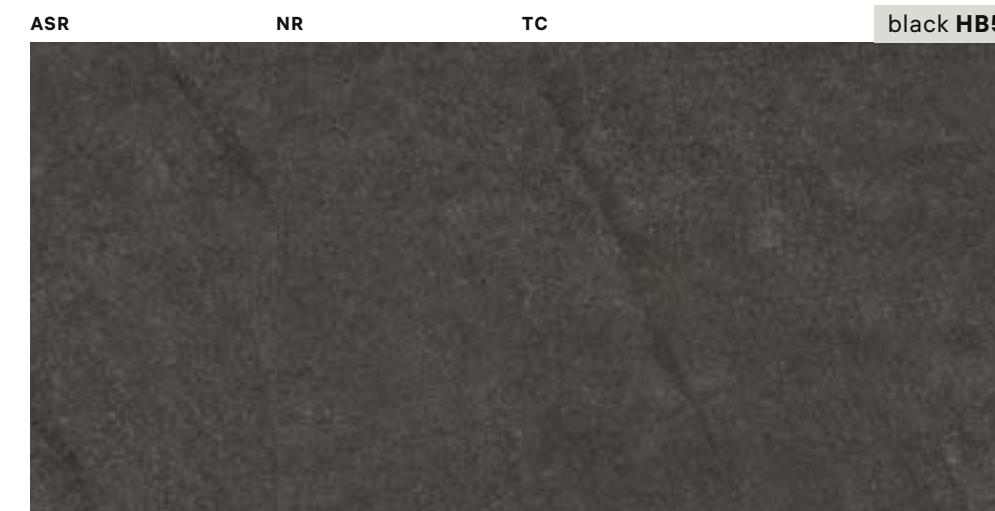

| | | | | |
|------------------|------|-----|-----|---------|
| 30x60 . 12"x24" | 10mm | NR | R10 | MG-2125 |
| | 10mm | TC | - | MG-2125 |
| | 10mm | ASR | R11 | MG-2125 |
| 60x60 . 24"x24" | 10mm | NR | R10 | MG-2810 |
| | 10mm | TC | - | MG-2810 |
| | 10mm | ASR | R11 | MG-2810 |
| 90x90 . 36"x36" | 11mm | NR | R10 | MG-4055 |
| | 11mm | TC | - | MG-4055 |
| | 11mm | ASR | R11 | MG-4055 |
| 60x120 . 24"x48" | 11mm | NR | R10 | MG-4720 |
| | 11mm | TC | - | MG-4720 |
| | 11mm | ASR | R11 | MG-4720 |

hybrid

collection

hybrid

collection

decors

décorations . dekorationen . decorações

10MM

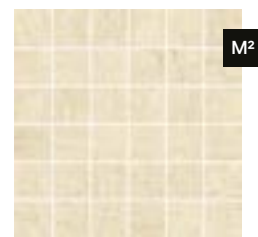

mosaic hybrid 5x5 white
30x30 . 12"x12"
TC MG-9570



mosaic hybrid 5x5 beige
30x30 . 12"x12"
TC MG-9570

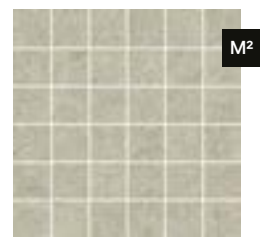

mosaic hybrid 5x5 light grey
30x30 . 12"x12"
TC MG-9570



mosaic hybrid 5x5 tortora
30x30 . 12"x12"
TC MG-9570

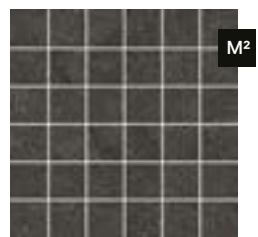

mosaic hybrid 5x5 black
30x30 . 12"x12"
TC MG-9570

10MM



bricks hybrid white
30x48 . 12"x19"
TC MP-6320



bricks hybrid beige
30x48 . 12"x19"
TC MP-6320

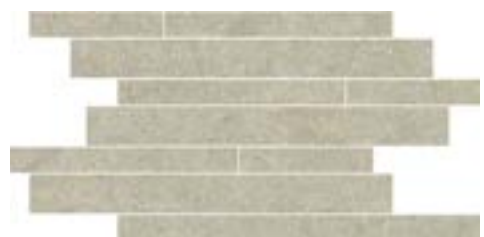

bricks hybrid light grey
30x48 . 12"x19"
TC MP-6320



bricks hybrid tortora
30x48 . 12"x19"
TC MP-6320



bricks hybrid black
30x48 . 12"x19"
TC MP-6320

special pieces

pièces spéciales . spezialteile . peças especiais

11 . 10MM

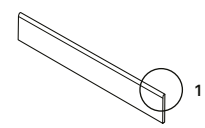

skirting
plinthe
sockel
rodapé boleado

8x60 . 3,2"x24"
NR . TC MP-6170
8x90 . 3,2"x36"
NR . TC MP-6260
8x120 . 3,2"x48"
NR . TC MP-6260

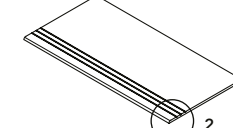
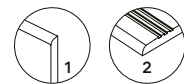

step tread grooved
nez de marche creusé
stufenplatte mit rillen
degrau sulcado

30x60 . 12"x24"
NR . TC . ASR MP-6240
30x90 . 12"x36"
NR . TC . ASR MP-6430
30x120 . 12"x48"
NR . TC . ASR MP-6445

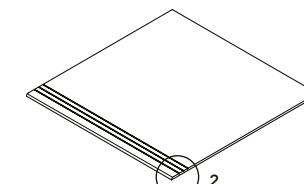

step tread grooved
nez de marche creusé
stufenplatte mit rillen
degrau sulcado

60x60 . 24"x24"
NR . TC . ASR MP-6400

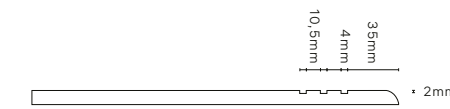

11 . 10MM

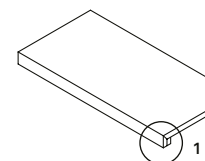

step extra thick
nez de marche forte épaisseur
massive stufenplatte
degrau espessurado

30x60 . 12"x24"
NR . TC MP-6560
30x120 . 12"x48"
NR . TC MP-6595

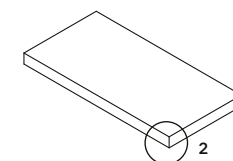
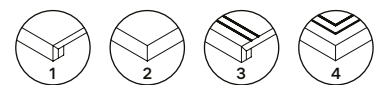

step extra thick corner*
nez de marche forte épaisseur angle*
ecke massive stufenplatte*
degrau espessurado canto*

30x60 . 12"x24"
NR . TC MP-6630
30x120 . 12"x48"
NR . TC MP-6655

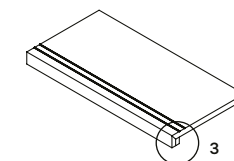

step extra thick inox
nez de marche forte épaisseur inox
massive stufenplatte inox
degrau espessurado inox

30x60 . 12"x24"
NR . TC MP-6580
30x120 . 12"x48"
NR . TC MP-6670

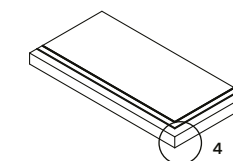

step extra thick corner inox*
nez de marche forte épaisseur angle inox*
ecke massive stufenplatte inox*
degrau espessurado canto inox*

30x60 . 12"x24"
NR . TC MP-6650
30x120 . 12"x48"
NR . TC MP-6710

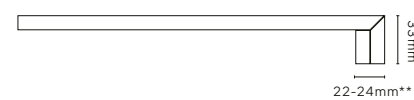

step extra thick corner . nez de marche forte épaisseur angle
ecke massive stufenplatte . degrau espessurado canto

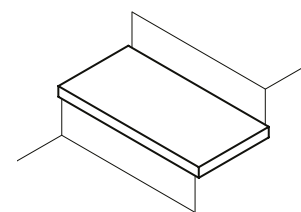

right corner . angle droit
rechten ecke . canto direito

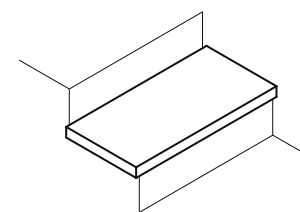

left corner . angle gauche
links ecke . canto esquerdo



step extra thick corner inox . nez de marche forte épaisseur angle inox
ecke massive stufenplatte inox . degrau espessurado canto inox

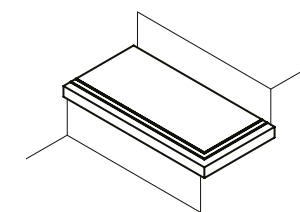

right corner . angle droit
rechten ecke . canto direito

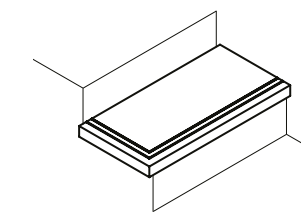

left corner . angle gauche
links ecke . canto esquerdo

Mosaic and Brick decors are net mounted. All decors may feature shade variations regarding the corresponding floor/wall tile standard tile.
Les décorations Mosaic et Brick sont sur trame. Toutes les décorations peuvent souffrir variations de tonalité par rapport aux carreaux base.
Die Mosaic und Brick Dekoration liegen auf einem Netz. Alle Dekorationen können im Vergleich zu den jeweiligen Grundiesen Farbunterschiede aufweisen.
As decorações Mosaic and Brick são sobre rede. Todas as decorações podem sofrer variações de tonalidade em relação aos respectivos mosaicos base.

MARGRES
CERAMIC TILES

Available in all colours
Disponible dans toutes les couleurs
Erhältlich in allen Farben
Disponível em todas as cores

*Available in right and left corner
*Disponible dans les coin droit et gauche
*Erhältlich in der rechten Ecke und links
*Disponível no canto direito e esquerdo

** Dimension will vary depending on the base tile thickness.
** La dimension varie selon l'épaisseur du carreau.
** das Maß variiert je nach Dicke der Fliese.
** A dimensão varia consoante a espessura do material cerâmico.

index

colour map

collections

concept

endless

evoke

grove

hybrid

jungle

metropolis

natural

prestige

pure stone

slabstone

stage

subway

tecnica

time 2.0

tool

linea collections

useful information







light grey EV3 60x120 NR . 60x60 NR

FULL BODY
PORCELAIN

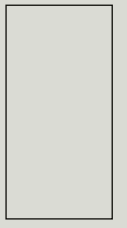
evoke
collection

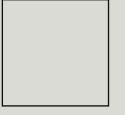
- ↓
DOWNLOAD
CATALOGUE
- ↓
DOWNLOAD
CATALOGUE
OUTDOOR
EXTRA THICK
- ↓
DOWNLOAD
TECHNICAL
FEATURES
- 🌐
VIEW
ONLINE

| | | | |
|---|---|---|---|
|  |  |  |  |
| 60x120 NR 9,5mm TC 9,5mm E ASR 20mm | 90x90 NR 9,5mm TC 9,5mm E ASR 20mm | 60x60 NR 8,5mm TC 8,5mm ASR 8,5mm | 30x60 NR 8,5mm |

rectified products . produits rectifiés . rektifizierete produkte . produtos retificados



white EV1 beige EV2 light grey EV3 grey EV4

UGL **V3** **R11** **R10** 
ASR NR



pour plus d'informations, consultez
<https://evaluation.cstb.fr>

MARGRES
CERAMIC TILES

- index
- colour map
- collections**
- concept
- endless
- evoke**
- grove
- hybrid
- jungle
- metropolis
- natural
- prestige
- pure stone
- slabstone
- stage
- subway
- tecnica
- time 2.0
- tool

- linea collections
- useful information



106

general catalogue . 2024



107

general catalogue . 2024

index

colour map

collections

concept

endless

evoke

grove

hybrid

jungle

metropolis

natural

prestige

pure stone

slabstone

stage

subway

tecnica

time 2.0

tool

linea collections

useful information





110

general catalogue . 2024

beige EV2 60x60 ASR

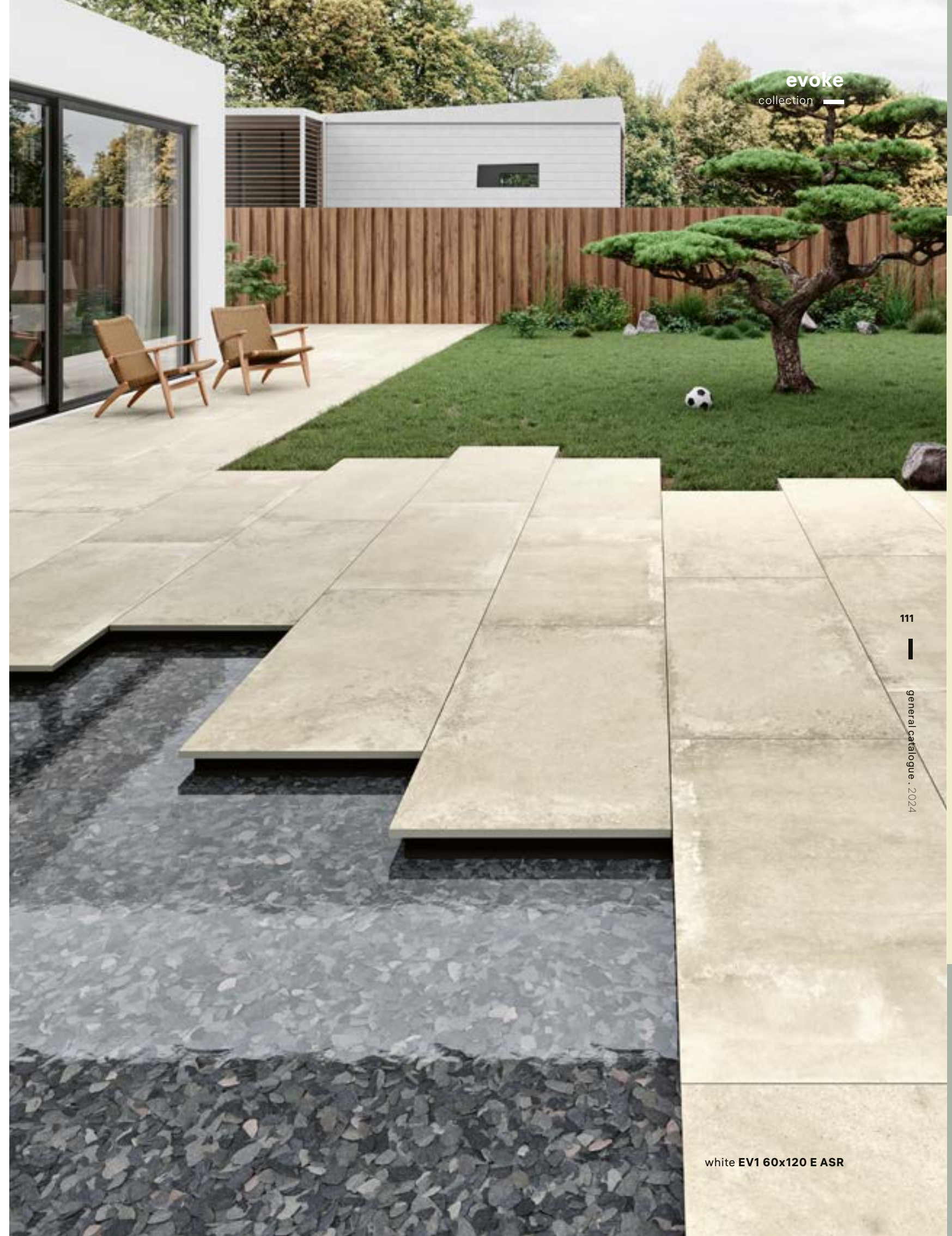

111

general catalogue . 2024

white EV1 60x120 E ASR

index

colour map

collections

concept

endless

evoke

grove

hybrid

jungle

metropolis

natural

prestige

pure stone

slabstone

stage

subway

tecnica

time 2.0

tool

linea collections

useful information

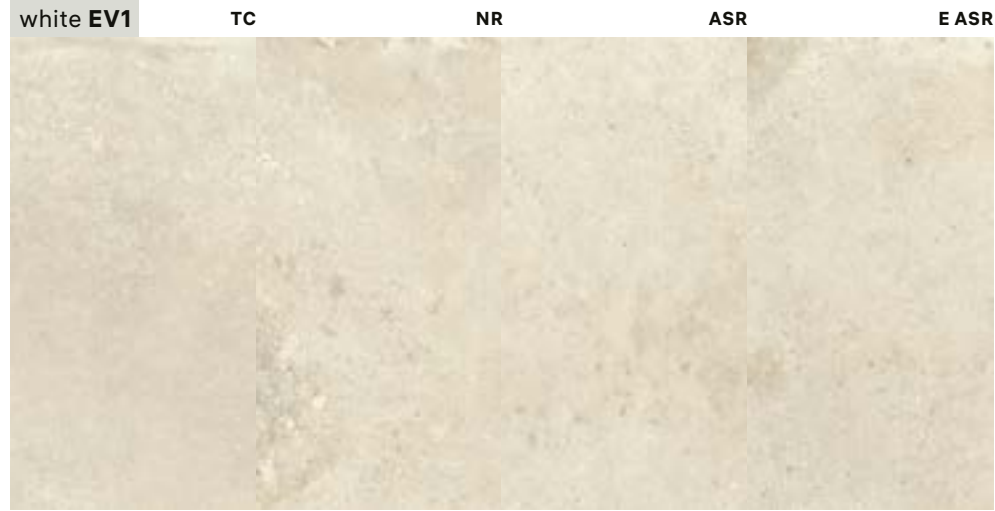

| | | | | |
|-------------------------|-------|--------------|-----|---------|
| 30x60 . 12"x24" | 8,5mm | NR | R10 | MG-2095 |
| | 8,5mm | NR | R10 | MG-2765 |
| 60x60 . 24"x24" | 8,5mm | TC | - | MG-2765 |
| | 8,5mm | ASR | R11 | MG-2765 |
| 90x90 . 36"x36" | 9,5mm | NR | R10 | MG-3960 |
| | 9,5mm | TC | - | MG-3960 |
| | 20mm | E ASR | R11 | MG-7690 |
| 60x120 . 24"x48" | 9,5mm | NR | R10 | MG-4695 |
| | 9,5mm | TC | - | MG-4695 |
| | 20mm | E ASR | R11 | MG-7490 |



| | | | | |
|-------------------------|-------|------------|-----|---------|
| 30x60 . 12"x24" | 8,5mm | NR | R10 | MG-2095 |
| | 8,5mm | NR | R10 | MG-2765 |
| 60x60 . 24"x24" | 8,5mm | TC | - | MG-2765 |
| | 8,5mm | ASR | R11 | MG-2765 |
| 90x90 . 36"x36" | 9,5mm | NR | R10 | MG-3960 |
| | 9,5mm | TC | - | MG-3960 |
| 60x120 . 24"x48" | 9,5mm | NR | R10 | MG-4695 |
| | 9,5mm | TC | - | MG-4695 |



| | | | | |
|-------------------------|-------|--------------|-----|---------|
| 30x60 . 12"x24" | 8,5mm | NR | R10 | MG-2095 |
| | 8,5mm | NR | R10 | MG-2765 |
| 60x60 . 24"x24" | 8,5mm | TC | - | MG-2765 |
| | 8,5mm | ASR | R11 | MG-2765 |
| 90x90 . 36"x36" | 9,5mm | NR | R10 | MG-3960 |
| | 9,5mm | TC | - | MG-3960 |
| | 20mm | E ASR | R11 | MG-7690 |
| 60x120 . 24"x48" | 9,5mm | NR | R10 | MG-4695 |
| | 9,5mm | TC | - | MG-4695 |
| | 20mm | E ASR | R11 | MG-7490 |



| | | | | |
|-------------------------|-------|--------------|-----|---------|
| 30x60 . 12"x24" | 8,5mm | NR | R10 | MG-2095 |
| | 8,5mm | NR | R10 | MG-2765 |
| 60x60 . 24"x24" | 8,5mm | TC | - | MG-2765 |
| | 8,5mm | ASR | R11 | MG-2765 |
| 90x90 . 36"x36" | 9,5mm | NR | R10 | MG-3960 |
| | 9,5mm | TC | - | MG-3960 |
| | 20mm | E ASR | R11 | MG-7690 |
| 60x120 . 24"x48" | 9,5mm | NR | R10 | MG-4695 |
| | 9,5mm | TC | - | MG-4695 |
| | 20mm | E ASR | R11 | MG-7490 |

decors

décorations . dekorationen . decorações

8,5MM

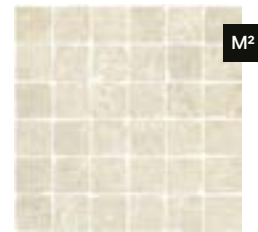

mosaic evoke 5x5 white
30x30 . 12"x12"
NR MG-9640



mosaic evoke 5x5 beige
30x30 . 12"x12"
NR MG-9640



mosaic evoke 5x5 light grey
30x30 . 12"x12"
NR MG-9640

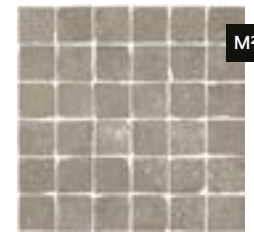

mosaic evoke 5x5 grey
30x30 . 12"x12"
NR MG-9640

8,5MM



bricks evoke white
30x30 . 12"x12"
TC MG-9640

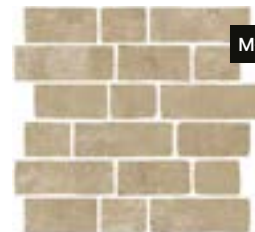

bricks evoke beige
30x30 . 12"x12"
TC MG-9640



bricks evoke light grey
30x30 . 12"x12"
TC MG-9640



bricks evoke grey
30x30 . 12"x12"
TC MG-9640

special pieces

pièces spéciales . spezialteile . peças especiais

9,5 . 8,5MM

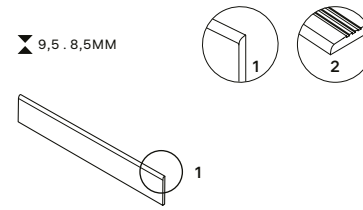

skirting
plinthe
sockel
rodapé boleado

8x60 . 3,2"x24"
NR . TC MP-6170
8x90 . 3,2"x36"
NR . TC MP-6260
8x120 . 3,2"x48"
NR . TC MP-6260

step tread grooved
nez de marche creusé
stufenplatte mit rillen
degrau sulcado

30x60 . 12"x24"
NR . TC . ASR MP-6240
30x90 . 12"x36"
NR . TC MP-6430
30x120 . 12"x48"
NR . TC MP-6445

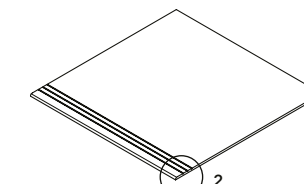

step tread grooved
nez de marche creusé
stufenplatte mit rillen
degrau sulcado

60x60 . 24"x24"
NR . TC . ASR MP-6400



9,5 . 8,5MM

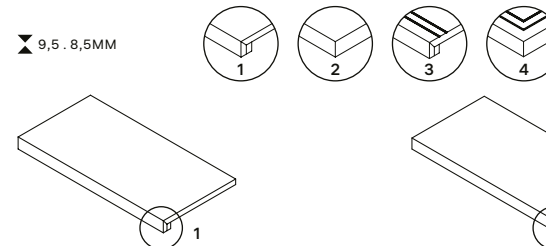

step extra thick
nez de marche forte épaisseur
massive stufenplatte
degrau espessurado

30x60 . 12"x24"
NR . TC MP-6560
30x120 . 12"x48"
NR . TC MP-6595

step extra thick corner*
nez de marche forte épaisseur angle*
ecke massive stufenplatte*
degrau espessurado canto*

30x60 . 12"x24"
NR . TC MP-6630
30x120 . 12"x48"
NR . TC MP-6655

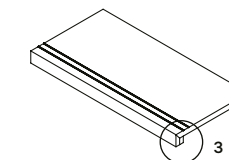

step extra thick inox
nez de marche forte épaisseur inox
massive stufenplatte inox
degrau espessurado inox

30x60 . 12"x24"
NR . TC MP-6580
30x120 . 12"x48"
NR . TC MP-6670

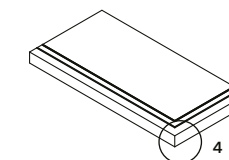

step extra thick corner inox*
nez de marche forte épaisseur angle inox*
ecke massive stufenplatte inox*
degrau espessurado canto inox*

30x60 . 12"x24"
NR . TC MP-6650
30x120 . 12"x48"
NR . TC MP-6710



step extra thick corner . nez de marche forte épaisseur angle
ecke massive stufenplatte . degrau espessurado canto

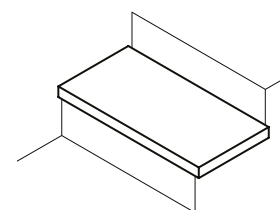

right corner . angle droit
rechten ecke . canto direito

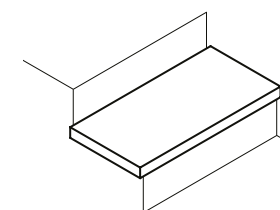

left corner . angle gauche
links ecke . canto esquerdo



step extra thick corner inox . nez de marche forte épaisseur angle inox
ecke massive stufenplatte inox . degrau espessurado canto inox

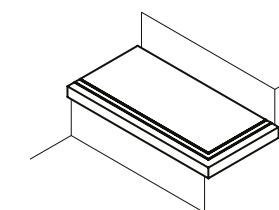

right corner . angle droit
rechten ecke . canto direito

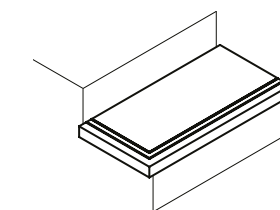

left corner . angle gauche
links ecke . canto esquerdo

Mosaic and Brick decors are net mounted. All decors may feature shade variations regarding the corresponding floor/wall tile standard tile.
Les décorations Mosaic et Brick sont sur trame. Toutes les décorations peuvent souffrir variations de tonalité par rapport aux carreaux base.
Die Mosaic und Brick Dekoration liegen auf einem Netz. Alle Dekorationen können im Vergleich zu den jeweiligen Grundiesen Farbunterschiede aufweisen.
As decorações Mosaic and Brick são sobre rede. Todas as decorações podem sofrer variações de tonalidade em relação aos respectivos mosaicos base.

Available in all colours
Disponible dans toutes les couleurs
Erhältlich in allen Farben
Disponível em todas as cores

*Available in right and left corner
*Disponible dans les coin droit et gauche
*Erhältlich in der rechten Ecke und links
*Disponível no canto direito e esquerdo

** Dimension will vary depending on the base tile thickness.
** La dimension varie selon l'épaisseur du carreau.
** das Maß variiert je nach Dicke der Fliese.
** A dimensão varia consoante a espessura do material cerâmico.

OUTDOOR
EXTRA THICK
Special 20MM pieces please refer to page 320.
Pièces spéciales 20MM, veuillez consulter la page 320.
Speziellanfertigungen 20MM siehe Seite 320.
Peças especiais 20MM, por favor consulte a página 320.



brown JU2 20x120 N

DIGITEK
PORCELAIN
STONEWARE

jungle
collection

- ↓ DOWNLOAD CATALOGUE
- ↓ DOWNLOAD CATALOGUE OUTDOOR EXTRA THICK
- ↓ DOWNLOAD TECHNICAL FEATURES
- 🌐 VIEW ONLINE

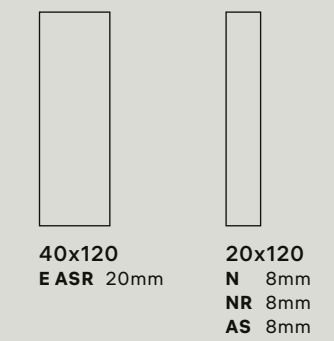

N . AS non-rectified products . produits non rectifiés . nicht rektifizierte produkte . produtos não retificados
NR . E ASR rectified products . produits rectifiés . rektifizierte produkte . produtos retificados



beige
JU1

brown
JU2

grey
JU3

UGL **V4** **R11** **R10**

AS . ASR N . NR

MARGRES
CERAMIC TILES

index

colour map

collections

- concept
- endless
- evoke
- grove
- hybrid
- jungle**
- metropolis
- natural
- prestige
- pure stone
- slabstone
- stage
- subway
- tecnica
- time 2.0
- tool

linea collections

useful information



concept

endless

evoke

grove

hybrid

jungle

metropolis

natural

prestige

pure stone

slabstone

stage

subway

tecnica

time 2.0

tool

linea collections

useful information



120

121

general catalogue . 2024

general catalogue

jungle
collection

jungle
collection

index

colour map

collections

concept

endless

evoke

grove

hybrid

jungle

metropolis

natural

prestige

pure stone

slabstone

stage

subway

tecnica

time 2.0

tool

linea collections

useful information

beige JU1 40x120 F ASR

122

general catalogue . 2024

123

general catalogue . 2024

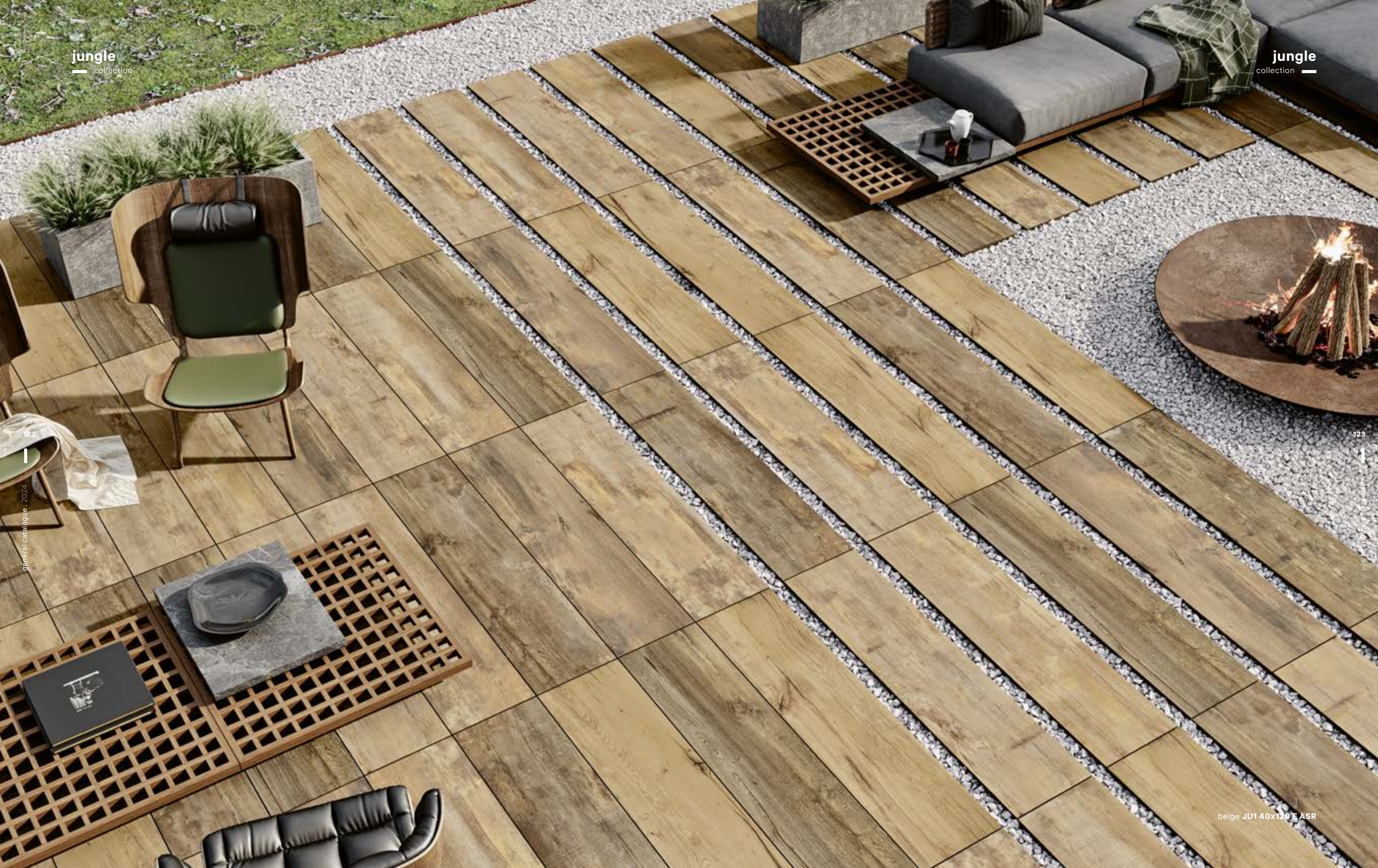



jungle
collection

124

general catalogue . 2024

beige JU1 20x120 N

jungle
collection

index

colour map

collections

concept

endless

evoke

grove

hybrid

jungle

metropolis

natural

prestige

pure stone

slabstone

stage

subway

tecnica

time 2.0

tool

linea collections

useful information

| | | | | |
|------------------|------|--------------|-----|---------|
| 20x120 . 8"x48" | 8mm | N | R10 | MG-1230 |
| | 8mm | NR | R10 | MG-1340 |
| | 8mm | AS | R11 | MG-1255 |
| 40x120 . 16"x48" | 20mm | E ASR | R11 | MG-7290 |

| | | | | |
|-----------------|-----|-----------|-----|---------|
| 20x120 . 8"x48" | 8mm | N | R10 | MG-1230 |
| | 8mm | NR | R10 | MG-1340 |
| | 8mm | AS | R11 | MG-1255 |

| | | | | |
|-----------------|-----|-----------|-----|---------|
| 20x120 . 8"x48" | 8mm | N | R10 | MG-1230 |
| | 8mm | NR | R10 | MG-1340 |
| | 8mm | AS | R11 | MG-1255 |

Pictures represent a random pattern based on five 20x120 tiles.
 Les images représentent le modèle aléatoire de cinq carreaux 20x120.
 Die Bilder repräsentieren das zufällige Muster von fünf 20x120 Stücke.
 As imagens representam o padrão aleatório de cinco peças 20x120.

OUTDOOR
EXTRA THICK

Special 20MM pieces please refer to page 320.
 Pièces spéciales 20MM, veuillez consulter la page 320.
 Spezialanfertigungen 20MM siehe Seite 320.
 Peças especiais 20MM, por favor consulte a página 320.

special pieces

pièces spéciales . spezialteile . peças especiais

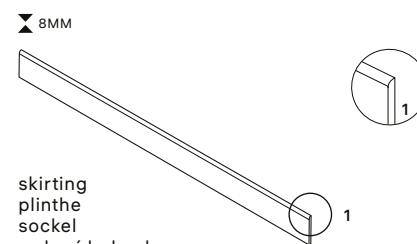

skirting
plinthe
sockel
rodapé boleado

8x120 . 3,2"x 48"
N MP-6200
NR MP-6260

Available in all colours
 Disponible dans toutes les couleurs
 Erhältlich in allen Farben
 Disponível em todas as cores

E ASR AS N. NR beige JU1

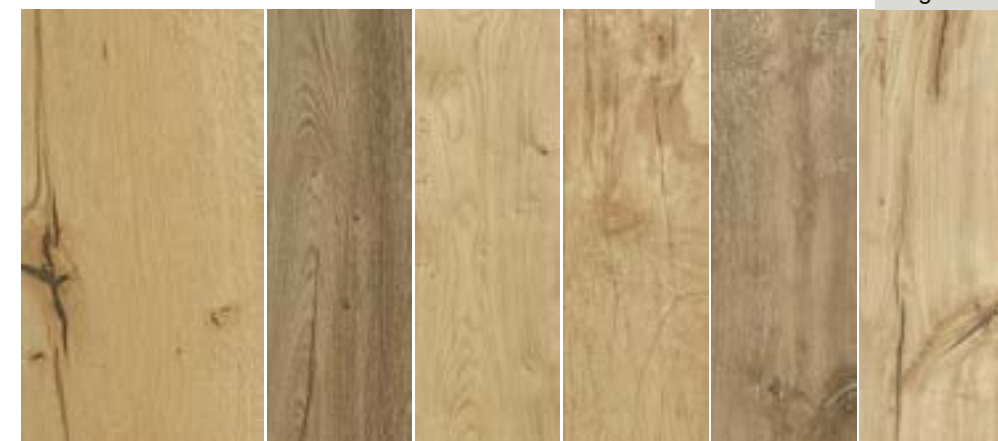

AS N. NR brown JU2

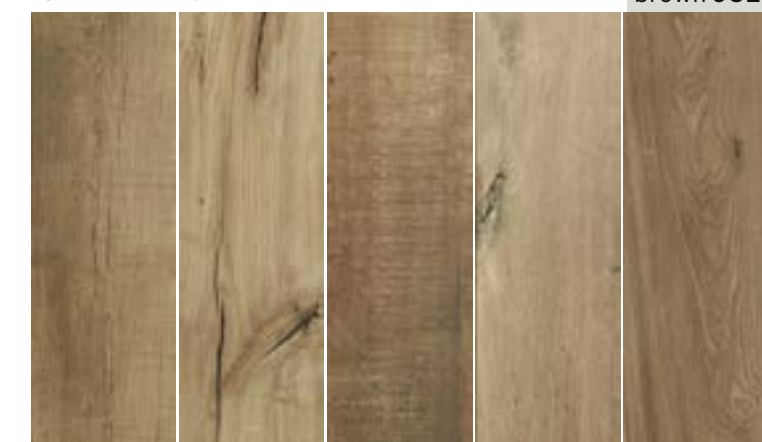

AS N. NR grey JU3



laying suggestions

suggestions de pose . anwendungsvorschläge . sugestões de aplicação

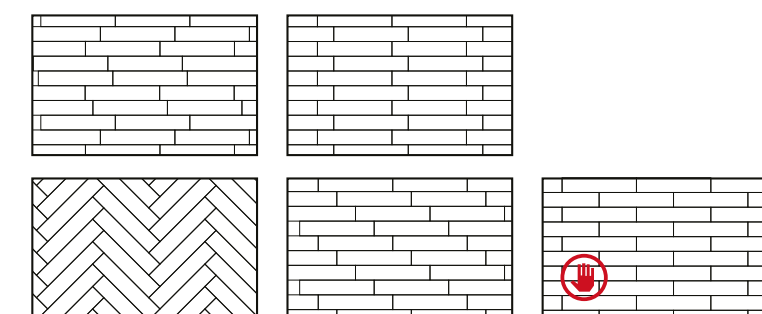

125

general catalogue . 2024



calacatta PT1 60x120 NR . 60x60 P

LAMINATED
PORCELAIN
STONEWARE

DIGITEK
PORCELAIN
STONEWARE

prestige
collection

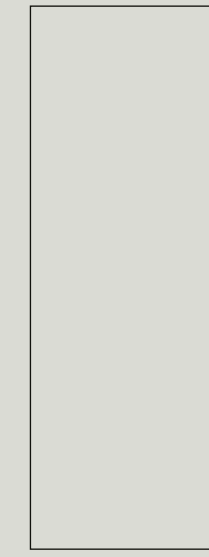

100x300
NR . P 5,5mm

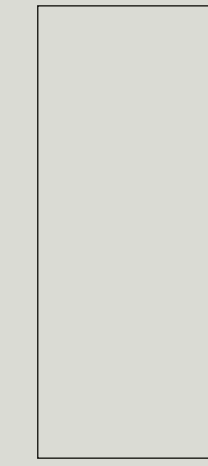

100x250
NR . P 5,5mm

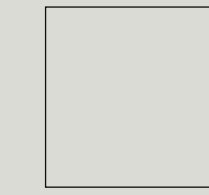

100x100
NR . P . ASR 5,5mm



50x100
NR . P 5,5mm

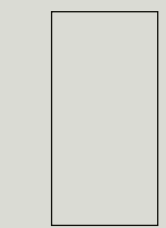

60x120
NR . P 9,5mm



90x90 . 89x89
NR P 9,5mm

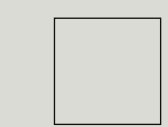

60x60
NR . P 8,5mm

↓
DOWNLOAD
CATALOGUE

↓
DOWNLOAD
TECHNICAL
FEATURES

🌐
VIEW
ONLINE

rectified products . produits rectifiés . rektifizierete produkte . produtos retificados



calacatta
PT1 . LPT1

corinthian
beige
PT2 . LPT2

travertino
grey
PT3 . LPT3

fior di bosco
tortora
PT4 . LPT4

emperador
black
PT5 . LPT5

UGL V2 R10
ASR NR . ASR P

PROTECT
Antibacterial for Life.

MARGRES
CERAMIC TILES

index

colour map

collections

concept

endless

evoke

grove

hybrid

jungle

metropolis

natural

prestige

pure stone

slabstone

stage

subway

tecnica

time 2.0

tool

linea collections

useful information

prestige
collection

prestige
collection

index

colour map

collections

concept

endless

evoke

grove

hybrid

jungle

metropolis

natural

prestige

pure stone

slabstone

stage

subway

tecnica

time 2.0

tool

linea collections

useful information

corinthian beige PT2 89x89 P

128

129

general catalogue . 2024

general catalogue . 2024



index

colour map

collections

concept

endless

evoke

grove

hybrid

jungle

metropolis

natural

prestige

pure stone

slabstone

stage

subway

tecnica

time 2.0

tool

linea collections

useful information

concept

endless

evoke

grove

hybrid

jungle

metropolis

natural

prestige

pure stone

slabstone

stage

subway

tecnica

time 2.0

tool

linea collections

useful information





| | | | | |
|------------------|-------|----|---|---------|
| 60x60 . 24"x24" | 8,5mm | NR | - | MG-2775 |
| | 8,5mm | P | - | MG-3280 |
| 89x89 . 35"x35" | 9,5mm | P | - | MG-4470 |
| 90x90 . 36"x36" | 9,5mm | NR | - | MG-3955 |
| 60x120 . 24"x48" | 9,5mm | NR | - | MG-4680 |
| | 9,5mm | P | - | MG-5160 |

LINEA

| | | | | |
|-----------------------|-------|-----|-----|---------|
| 50x100 . 19,6"x39,4" | 5,5mm | NR | - | M3-1930 |
| | 5,5mm | P | - | M3-2330 |
| | 5,5mm | ASR | R10 | M3-2730 |
| 100x100 . 39,4"x39,4" | 5,5mm | NR | - | M3-2730 |
| | 5,5mm | P | - | M3-3130 |
| 100x250 . 39,4"x98,4" | 5,5mm | NR | - | M3-3530 |
| | 5,5mm | P | - | M3-3830 |
| 100x300 . 39,4"x118" | 5,5mm | NR | - | M3-4230 |
| | 5,5mm | P | - | M3-4630 |



| | | | | |
|------------------|-------|----|---|---------|
| 60x60 . 24"x24" | 8,5mm | NR | - | MG-2775 |
| | 8,5mm | P | - | MG-3280 |
| 89x89 . 35"x35" | 9,5mm | P | - | MG-4470 |
| 90x90 . 36"x36" | 9,5mm | NR | - | MG-3955 |
| 60x120 . 24"x48" | 9,5mm | NR | - | MG-4680 |
| | 9,5mm | P | - | MG-5160 |

LINEA

| | | | | |
|-----------------------|-------|----|---|---------|
| 50x100 . 19,6"x39,4" | 5,5mm | NR | - | M3-1930 |
| | 5,5mm | P | - | M3-2330 |
| 100x100 . 39,4"x39,4" | 5,5mm | NR | - | M3-2730 |
| | 5,5mm | P | - | M3-3130 |
| 100x250 . 39,4"x98,4" | 5,5mm | NR | - | M3-3530 |
| | 5,5mm | P | - | M3-3830 |
| 100x300 . 39,4"x118" | 5,5mm | NR | - | M3-4230 |
| | 5,5mm | P | - | M3-4630 |



| | | | | |
|------------------|-------|----|---|---------|
| 60x60 . 24"x24" | 8,5mm | NR | - | MG-2775 |
| | 8,5mm | P | - | MG-3280 |
| 89x89 . 35"x35" | 9,5mm | P | - | MG-4470 |
| 90x90 . 36"x36" | 9,5mm | NR | - | MG-3955 |
| 60x120 . 24"x48" | 9,5mm | NR | - | MG-4680 |
| | 9,5mm | P | - | MG-5160 |

LINEA

| | | | | |
|-----------------------|-------|----|---|---------|
| 50x100 . 19,6"x39,4" | 5,5mm | NR | - | M3-1930 |
| | 5,5mm | P | - | M3-2330 |
| 100x100 . 39,4"x39,4" | 5,5mm | NR | - | M3-2730 |
| | 5,5mm | P | - | M3-3130 |
| 100x250 . 39,4"x98,4" | 5,5mm | NR | - | M3-3530 |
| | 5,5mm | P | - | M3-3830 |
| 100x300 . 39,4"x118" | 5,5mm | NR | - | M3-4230 |
| | 5,5mm | P | - | M3-4630 |

| | | | | |
|------------------|-------|----|---|---------|
| 60x60 . 24"x24" | 8,5mm | NR | - | MG-2775 |
| | 8,5mm | P | - | MG-3280 |
| 89x89 . 35"x35" | 9,5mm | P | - | MG-4470 |
| 90x90 . 36"x36" | 9,5mm | NR | - | MG-3955 |
| 60x120 . 24"x48" | 9,5mm | NR | - | MG-4680 |
| | 9,5mm | P | - | MG-5160 |

LINEA

| | | | | |
|-----------------------|-------|----|---|---------|
| 50x100 . 19,6"x39,4" | 5,5mm | NR | - | M3-1930 |
| | 5,5mm | P | - | M3-2330 |
| 100x100 . 39,4"x39,4" | 5,5mm | NR | - | M3-2730 |
| | 5,5mm | P | - | M3-3130 |
| 100x250 . 39,4"x98,4" | 5,5mm | NR | - | M3-3530 |
| | 5,5mm | P | - | M3-3830 |
| 100x300 . 39,4"x118" | 5,5mm | NR | - | M3-4230 |
| | 5,5mm | P | - | M3-4630 |

| | | | | |
|------------------|-------|----|---|---------|
| 60x60 . 24"x24" | 8,5mm | NR | - | MG-2775 |
| | 8,5mm | P | - | MG-3280 |
| 89x89 . 35"x35" | 9,5mm | P | - | MG-4470 |
| 90x90 . 36"x36" | 9,5mm | NR | - | MG-3955 |
| 60x120 . 24"x48" | 9,5mm | NR | - | MG-4680 |
| | 9,5mm | P | - | MG-5160 |

LINEA

| | | | | |
|-----------------------|-------|----|---|---------|
| 50x100 . 19,6"x39,4" | 5,5mm | NR | - | M3-1930 |
| | 5,5mm | P | - | M3-2330 |
| 100x100 . 39,4"x39,4" | 5,5mm | NR | - | M3-2730 |
| | 5,5mm | P | - | M3-3130 |
| 100x250 . 39,4"x98,4" | 5,5mm | NR | - | M3-3530 |
| | 5,5mm | P | - | M3-3830 |
| 100x300 . 39,4"x118" | 5,5mm | NR | - | M3-4230 |
| | 5,5mm | P | - | M3-4630 |



Products with a polished finish are more sensitive to abrasion and stains, what requires special conditions. Please see page 328 in chapter 09.
Les produits à finition polie sont plus sensibles à l'abrasion et aux taches, ce qui requiert des conditions particulières. Veuillez-vous consulter la page 328 du chapitre 09.
Produkte mit einer polierten Oberfläche sind empfindlicher gegen Abrieb und Fleckenbildung, was besondere Bedingungen erfordert. Bitte beachten Sie Seite 328 in Kapitel 09.
Os produtos com acabamento polido são mais sensíveis à abrasão e às manchas, o que requer condições especiais. Por favor consulte a página 328 no capítulo 09.

PROTECT
Antibacterial for Life.

An exclusive line of extremely high performance antimicrobial floor and wall tiles, designed for healthy, safe and protected living spaces. Available only in Linea Range and in natural rectified and polished finishes.
Une ligne exclusive de sols et revêtements antibactériens aux performances très élevées, pour un habitat sain, sûr et protégé. Disponible uniquement dans la gamme Linea et dans les finitions naturel rectifié et poli.
Eine exklusive Linie an hochwertigen Fußböden und antibakteriellen Wandverkleidungen, für ein gesundes, sicheres und geschütztes Leben. Nur in der Linea Serie erhältlich und auf rektifiziert naturbelassen und poliert.
Uma linha exclusiva de pavimentos e revestimentos antimicrobianos de altíssima performance, projetada para ambientes saudáveis, seguros e protegidos. Disponível unicamente na gama Linea e nos acabamentos natural retificado e polido.

decors

décorations . dekorationen . decorações

8,5MM



mosaic prestige 4,4x5
(all colours)
30x30 . 12"x12"
NR MG-9580
P MG-9830



mosaic 2,3x2,3
summer spot
30x30 . 12"x12"
NR MG-9640
P MG-9885

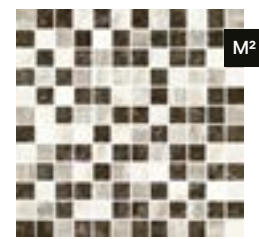

mosaic 2,3x2,3
winter spot
30x30 . 12"x12"
NR MG-9640
P MG-9885



bricks prestige
(all colours)
29,6x59,5 . 11,7"x23,4"
NR MP-6310
P MP-6330

8,5MM



mosaic shell
fior di bosco tortora
31x33 . 12"x13"
NR MP-6370
P MP-6380



mosaic shell
travertino grey
31x33 . 12"x13"
NR MP-6370
P MP-6380



mosaic shell
emperador black
31x33 . 12"x13"
NR MP-6370
P MP-6380

8,5MM



mosaic sharp* (all colours)
22x28,5 . 8,7"x11,2"
NR MP-6330
P MP-6350

Mosaic and Brick decors are net mounted. All decors may feature shade variations regarding the corresponding floor/wall tile standard tile.

Les décorations Mosaic et Brick sont sur trame. Toutes les décorations peuvent souffrir variations de tonalité par rapport aux carreaux base.

Die Mosaic und Brick Dekoration liegen auf einem Netz. Alle Dekorationen können im Vergleich zu den jeweiligen Grundiesen Farbunterschiede aufweisen.

As decorações Mosaic and Brick são sobre rede. Todas as decorações podem sofrer variações de tonalidade em relação aos respectivos mosaicos base.

* Decoration available in 4 different patterns, sold randomly. Please see page 97. Decorative pieces with precious metals are sensitive to acid attacks and must not be used for floors.

* Décoration avec 4 pièces différentes et vendues de façon aléatoire. Veuillez s'il vous plaît consulter la page 97. Les pièces décoratives en métaux précieux sont sensibles aux attaques d'acides et ne doivent pas être appliqués sur les carrelages.

* Dekoration in 4 verschiedenen Mustern erhältlich, nach dem Zufallsprinzip verkauft. Bitte sehen Sie Seite 97. Dekorative Teile mit Edelmetallen sind gegen Säure empfindlich und sollten nicht als Bodenbelag zum Einsatz kommen.

* Decoração com 4 peças diferentes e vendidas aleatoriamente. Por favor, ver a página 97. Peças decorativas com metais preciosos são sensíveis aos ataques ácidos e não devem ser aplicadas em pavimento.

special pieces

pièces spéciales . spezialteile . peças especiais

9,5 . 8,5MM

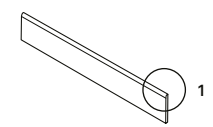

skirting
plinthe
socket
rodapé boleado

8x60 . 3,2"x24"
NR MP-6170
P MP-6180
8x89 . 3,2"x35"
P MP-6270
8x90 . 3,2"x36"
NR MP-6260
8x120 . 3,2"x48"
NR MP-6260
P MP-6270

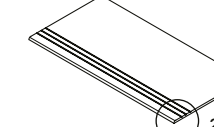
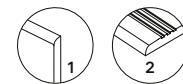

step tread grooved
nez de marche creusé
stufenplatte mit rillen
degrau sulcado

30x60 . 12"x24"
NR MP-6240
P MP-6270
30x89 . 12"x35"
P MP-6445
30x90 . 12"x36"
NR MP-6430
30x120 . 12"x48"
NR MP-6445
P MP-6470

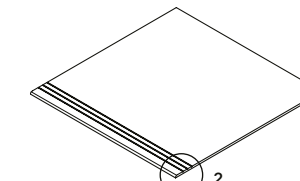

step tread grooved
nez de marche creusé
stufenplatte mit rillen
degrau sulcado

60x60 . 24"x24"
NR MP-6400
P MP-6430

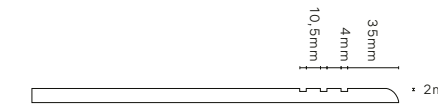

9,5 . 8,5MM

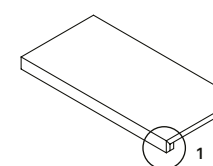

step extra thick
nez de marche forte épaisseur
massive stufenplatte
degrau espessurado

30x60 . 12"x24"
NR . P MP-6560
30x120 . 12"x48"
NR . P MP-6595

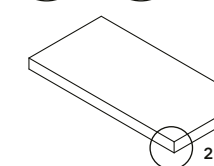
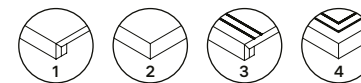

step extra thick corner*
nez de marche forte épaisseur angle*
ecke massive stufenplatte*
degrau espessurado canto*

30x60 . 12"x24"
NR . P MP-6630
30x120 . 12"x48"
NR . P MP-6655

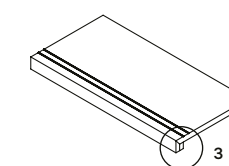

step extra thick inox
nez de marche forte épaisseur inox
massive stufenplatte inox
degrau espessurado inox

30x60 . 12"x24"
NR . P MP-6580
30x120 . 12"x48"
NR . P MP-6670

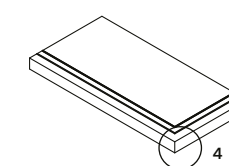

step extra thick corner inox*
nez de marche forte épaisseur angle inox*
ecke massive stufenplatte inox*
degrau espessurado canto inox*

30x60 . 12"x24"
NR . P MP-6650
30x120 . 12"x48"
NR . P MP-6710



step extra thick corner . nez de marche forte épaisseur angle
ecke massive stufenplatte . degrau espessurado canto

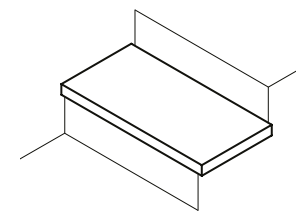

right corner . angle droit
rechten ecke . canto direito

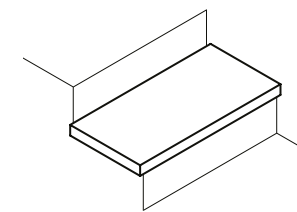

left corner . angle gauche
links ecke . canto esquerdo

Available in all colours
Disponible dans toutes les couleurs
Erhältlich in allen Farben
Disponível em todas as cores

*Available in right and left corner
*Disponible dans les coin droit et gauche
*Erhältlich in der rechten Ecke und links
*Disponível no canto direito e esquerdo



step extra thick corner inox . nez de marche forte épaisseur angle inox
ecke massive stufenplatte inox . degrau espessurado canto inox

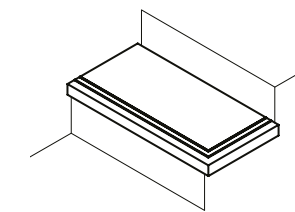

right corner . angle droit
rechten ecke . canto direito

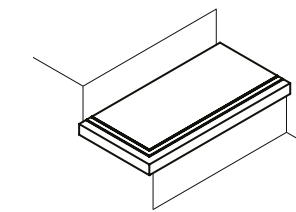

left corner . angle gauche
links ecke . canto esquerdo

** Dimension will vary depending on the base tile thickness.

** La dimension varie selon l'épaisseur du carreau.

** das Maß variiert je nach Dicke der Fliese.

** A dimensão varia consoante a espessura do material cerâmico.



MOOD
eat, drink & share

FULL BODY
PORCELAIN

concept

collection

- ↓ DOWNLOAD CATALOGUE
- ↓ DOWNLOAD TECHNICAL FEATURES
- 🌐 VIEW ONLINE

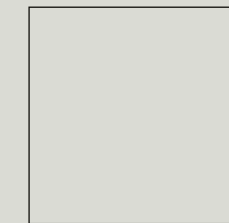

120x120
NR 9mm



60x120
NR 9,5mm
A 9,5mm



90x90
NR 9,5mm
A 9,5mm



45x90
NR 9mm
A 9mm
ASR 9mm

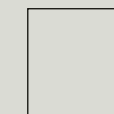

60x60
NR 8,5mm
A 8,5mm
ASR 8,5mm



30x60
NR 8,5mm
A 8,5mm

rectified products . produits rectifiés . rektifizierter produkte . produtos retificados



white
CT1

beige
CT2

light grey
CT3

grey
CT4

UGL V3 R11 R10

ASR NR



pour plus d'informations, consultez
<https://evaluation.cstb.fr>

MARGRES
CERAMIC TILES

index

colour map

collections

concept

endless

evoke

grove

hybrid

jungle

metropolis

natural

prestige

pure stone

slabstone

stage

subway

tecnica

time 2.0

tool



white CT1 60x60 A . 30x60 NR





144

145

general catalogue . 2024

general catalogue . 2024



beige CT2 90x90 A



146

general catalogue . 2024

light grey CT3 45x90 NR . 45x90 ASR



147

general catalogue . 2024

grey CT4 60x60 A

index

colour map

collections

concept

endless

evoke

grove

hybrid

jungle

metropolis

natural

prestige

pure stone

slabstone

stage

subway

tecnica

time 2.0

tool

linea collections

useful information



| | | | | |
|------------------|-------|-----|-----|---------|
| 30x60 . 12"x24" | 8,5mm | NR | R10 | MG-2095 |
| | 8,5mm | A | - | MG-2370 |
| 60x60 . 24"x24" | 8,5mm | NR | R10 | MG-2765 |
| | 8,5mm | A | - | MG-3080 |
| | 8,5mm | ASR | R11 | MG-2765 |
| 45x90 . 18"x36" | 9mm | NR | R10 | MG-3560 |
| | 9mm | A | - | MG-3730 |
| 90x90 . 36"x36" | 9mm | ASR | R11 | MG-3560 |
| | 9,5mm | NR | R10 | MG-3960 |
| 90x90 . 36"x36" | 9,5mm | A | - | MG-4290 |
| | 9,5mm | NR | R10 | MG-4695 |
| 60x120 . 24"x48" | 9,5mm | A | - | MG-4970 |
| | 9mm | NR | R10 | MG-5450 |



| | | | | |
|------------------|-------|-----|-----|---------|
| 30x60 . 12"x24" | 8,5mm | NR | R10 | MG-2095 |
| | 8,5mm | A | - | MG-2370 |
| 60x60 . 24"x24" | 8,5mm | NR | R10 | MG-2765 |
| | 8,5mm | A | - | MG-3080 |
| | 8,5mm | ASR | R11 | MG-2765 |
| 45x90 . 18"x36" | 9mm | NR | R10 | MG-3560 |
| | 9mm | A | - | MG-3730 |
| 90x90 . 36"x36" | 9mm | ASR | R11 | MG-3560 |
| | 9,5mm | NR | R10 | MG-3960 |
| 90x90 . 36"x36" | 9,5mm | A | - | MG-4290 |
| | 9,5mm | NR | R10 | MG-4695 |
| 60x120 . 24"x48" | 9,5mm | A | - | MG-4970 |



| | | | | |
|------------------|-------|-----|-----|---------|
| 30x60 . 12"x24" | 8,5mm | NR | R10 | MG-2095 |
| | 8,5mm | A | - | MG-2370 |
| 60x60 . 24"x24" | 8,5mm | NR | R10 | MG-2765 |
| | 8,5mm | A | - | MG-3080 |
| | 8,5mm | ASR | R11 | MG-2765 |
| 45x90 . 18"x36" | 9mm | NR | R10 | MG-3560 |
| | 9mm | A | - | MG-3730 |
| 90x90 . 36"x36" | 9mm | ASR | R11 | MG-3560 |
| | 9,5mm | NR | R10 | MG-3960 |
| 90x90 . 36"x36" | 9,5mm | A | - | MG-4290 |
| | 9,5mm | NR | R10 | MG-4695 |
| 60x120 . 24"x48" | 9,5mm | A | - | MG-4970 |
| | 9mm | NR | R10 | MG-5450 |

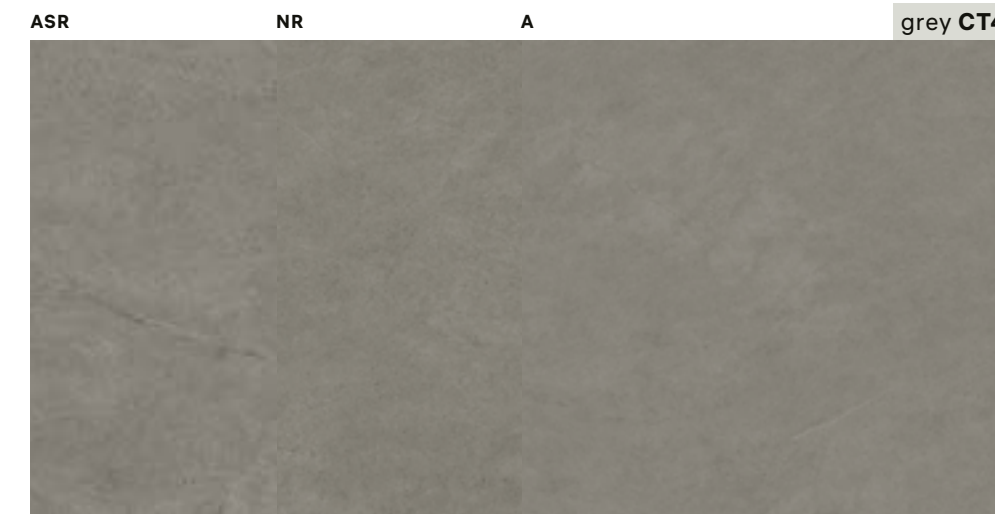

| | | | | |
|------------------|-------|-----|-----|---------|
| 30x60 . 12"x24" | 8,5mm | NR | R10 | MG-2095 |
| | 8,5mm | A | - | MG-2370 |
| 60x60 . 24"x24" | 8,5mm | NR | R10 | MG-2765 |
| | 8,5mm | A | - | MG-3080 |
| | 8,5mm | ASR | R11 | MG-2765 |
| 45x90 . 18"x36" | 9mm | NR | R10 | MG-3560 |
| | 9mm | A | - | MG-3730 |
| 90x90 . 36"x36" | 9mm | ASR | R11 | MG-3560 |
| | 9,5mm | NR | R10 | MG-3960 |
| 90x90 . 36"x36" | 9,5mm | A | - | MG-4290 |
| | 9,5mm | NR | R10 | MG-4695 |
| 60x120 . 24"x48" | 9,5mm | A | - | MG-4970 |

concept

collection

decors

décorations . dekorationen . decorações

8,5MM

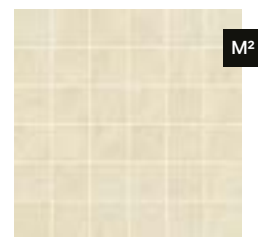

mosaic concept 5x5 white
30x30 . 12"x12"
NR MG-9570
A MG-9745



mosaic concept 5x5 beige
30x30 . 12"x12"
NR MG-9570
A MG-9745

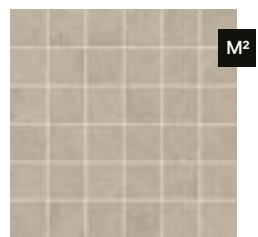

mosaic concept 5x5 light grey
30x30 . 12"x12"
NR MG-9570
A MG-9745

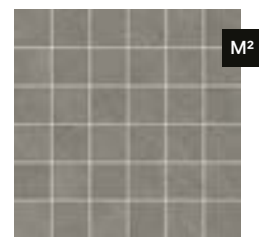

mosaic concept 5x5 grey
30x30 . 12"x12"
NR MG-9570
A MG-9745

8,5MM

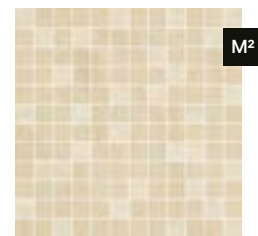

mosaic concept 2,3x2,3 white mix
30x30 . 12"x12"
A MG-9790



mosaic concept 2,3x2,3 grey mix
30x30 . 12"x12"
A MG-9790

8,5MM



bricks concept white
15x60 . 6"x24"
NR MP-6320
A MP-6330

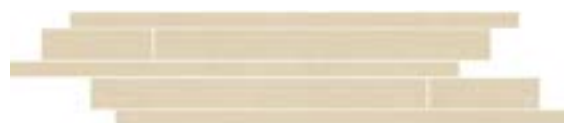

bricks concept beige
15x60 . 6"x24"
NR MP-6320
A MP-6330



bricks concept light grey
15x60 . 6"x24"
NR MP-6320
A MP-6330



bricks concept grey
15x60 . 6"x24"
NR MP-6320
A MP-6330

Mosaic and Brick decors are net mounted. All decors may feature shade variations regarding the corresponding floor/wall tile standard tile.
Les décorations Mosaic et Brick sont sur trame. Toutes les décorations peuvent souffrir variations de tonalité par rapport aux carreaux base.
Die Mosaic und Brick Dekoration liegen auf einem Netz. Alle Dekorationen können im Vergleich zu den jeweiligen Grundiesen Farbunterschiede aufweisen.
As decorações Mosaic and Brick são sobre rede. Todas as decorações podem sofrer variações de tonalidade em relação aos respectivos mosaicos base.

MARGRES
CERAMIC TILES

concept

collection

special pieces

pièces spéciales . spezialteile . peças especiais

9,5 . 8,5MM

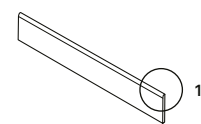

skirting
plinthe
sockel
rodapé boleado

8x60 . 3,2"x24"
NR MP-6170
A MP-6180
8x90 . 3,2"x36"
NR MP-6260
A MP-6270
8x120 . 3,2"x48"
NR MP-6260
A MP-6270

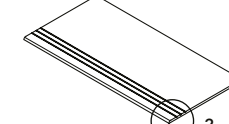
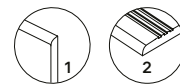

step tread grooved
nez de marche creusé
stufenplatte mit rillen
degrau sulcado

30x60 . 12"x24"
NR . ASR MP-6240
A MP-6270
30x90 . 12"x36"
NR . ASR MP-6430
A MP-6445
30x120 . 12"x48"
NR MP-6445
A MP-6470

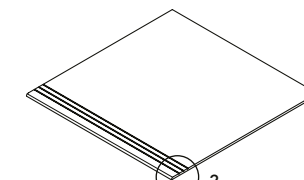

step tread grooved
nez de marche creusé
stufenplatte mit rillen
degrau sulcado

60x60 . 24"x24"
NR . ASR MP-6400
A MP-6430



9,5 . 8,5MM

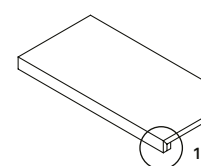

step extra thick
nez de marche forte épaisseur
massive stufenplatte
degrau espessurado

30x60 . 12"x24"
NR . A MP-6560
30x120 . 12"x48"
NR . A MP-6595

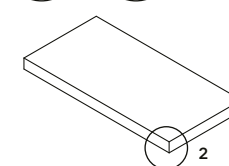
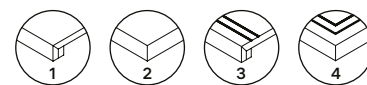

step extra thick corner*
nez de marche forte épaisseur angle*
ecke massive stufenplatte*
degrau espessurado canto*

30x60 . 12"x24"
NR . A MP-6630
30x120 . 12"x48"
NR . A MP-6655

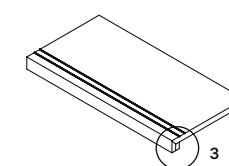

step extra thick inox
nez de marche forte épaisseur inox
massive stufenplatte inox
degrau espessurado inox

30x60 . 12"x24"
NR . A MP-6580
30x120 . 12"x48"
NR . A MP-6670

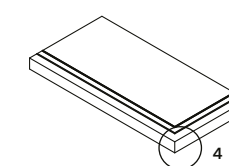

step extra thick corner inox*
nez de marche forte épaisseur angle inox*
ecke massive stufenplatte inox*
degrau espessurado canto inox*

30x60 . 12"x24"
NR . A MP-6650
30x120 . 12"x48"
NR . A MP-6710



step extra thick corner . nez de marche forte épaisseur angle
ecke massive stufenplatte . degrau espessurado canto

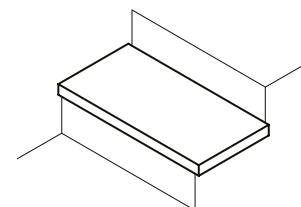

right corner . angle droit
rechten ecke . canto direito

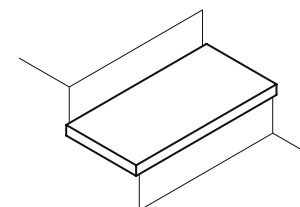

left corner . angle gauche
links ecke . canto esquerdo



step extra thick corner inox . nez de marche forte épaisseur angle inox
ecke massive stufenplatte inox . degrau espessurado canto inox

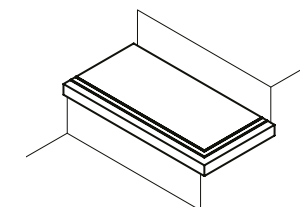

right corner . angle droit
rechten ecke . canto direito

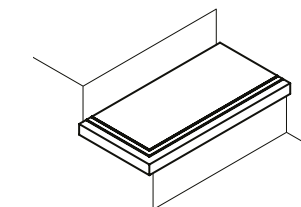

left corner . angle gauche
links ecke . canto esquerdo

Available in all colours
Disponible dans toutes les couleurs
Erhältlich in allen Farben
Disponível em todas as cores

*Available in right and left corner
*Disponible dans les coin droit et gauche
*Erhältlich in der rechten Ecke und links
*Disponível no canto direito e esquerdo

** Dimension will vary depending on the base tile thickness.
** La dimension varie selon l'épaisseur du carreau.
** das Maß variiert je nach Dicke der Fliese.
** A dimensão varia consoante a espessura do material cerâmico.

index

colour map

collections

concept

endless

evoke

grove

hybrid

jungle

metropolis

natural

prestige

pure stone

slabstone

stage

subway

tecnica

time 2.0

tool

linea collections

useful information



DIGITEK
PORCELAIN
STONEWARE

grove
collection

- 
 DOWNLOAD
CATALOGUE
- 
 DOWNLOAD
CATALOGUE
OUTDOOR
EXTRA THICK
- 
 DOWNLOAD
TECHNICAL
FEATURES
- 
 VIEW
ONLINE

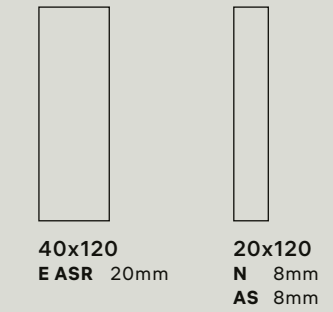

N . AS non-rectified products . produits non rectifiés . nicht rektifizierte produkte . produtos não retificados
E ASR rectified products . produits rectifiés . rektifizierte produkte . produtos retificados

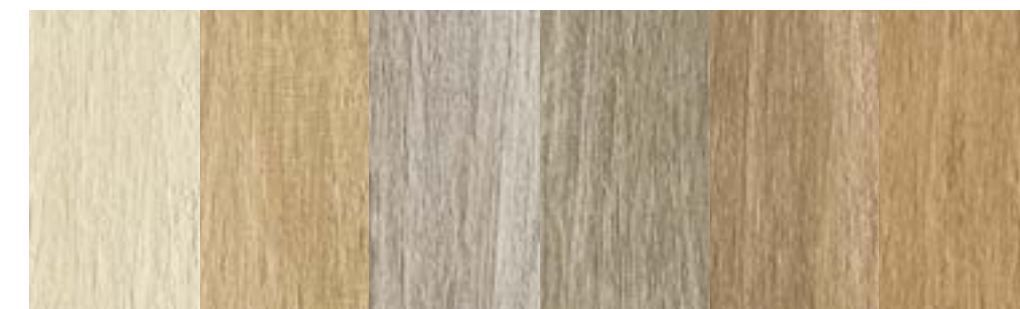

white GR1 beige GR2 grey GR3 tortora GR4 light brown GR5 brown GR6

UGL V2 R11 R10 
AS . ASR N

MARGRES
CERAMIC TILES

index

colour map

collections

concept

endless

evoke

grove

hybrid

jungle

metropolis

natural

prestige

pure stone

slabstone

stage

subway

tecnica

time 2.0

tool

linea collections

useful information

concept

endless

evoke

grove

hybrid

jungle

metropolis

natural

prestige

pure stone

slabstone

stage

subway

tecnica

time 2.0

tool

linea collections

useful information





156



157



general catalogue . 2024

general catalogue . 2024



158

general catalogue, 2024

159

general catalogue, 2024

light brown GR5 40x120 E ASR

index

colour map

collections

concept

endless

evoke

grove

hybrid

jungle

metropolis

natural

prestige

pure stone

slabstone

stage

subway

tecnica

time 2.0

tool

linea collections

useful information

grove
collection

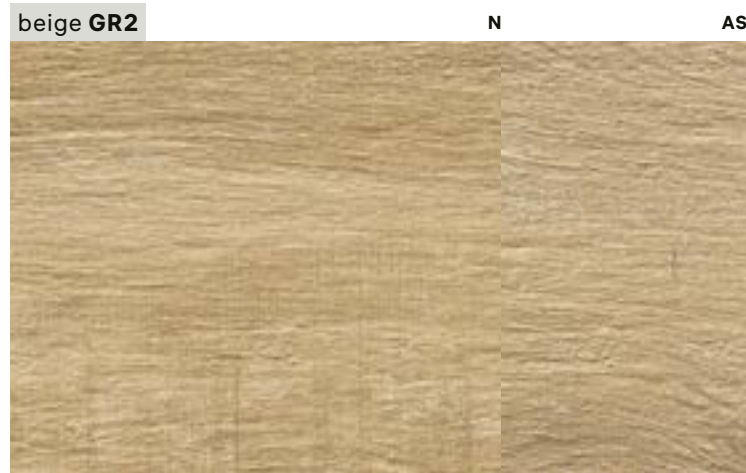

| | | | | |
|-----------------|-----|---|-----|---------|
| 20x120 . 8"x48" | 8mm | N | R10 | MG-1220 |
|-----------------|-----|---|-----|---------|

| | | | | |
|-----------------|-----|----|-----|---------|
| 20x120 . 8"x48" | 8mm | N | R10 | MG-1220 |
| | 8mm | AS | R11 | MG-1245 |

| | | | | |
|------------------|------|-------|-----|---------|
| 20x120 . 8"x48" | 8mm | N | R10 | MG-1220 |
| 40x120 . 16"x48" | 20mm | E ASR | R11 | MG-7290 |

grove
collection

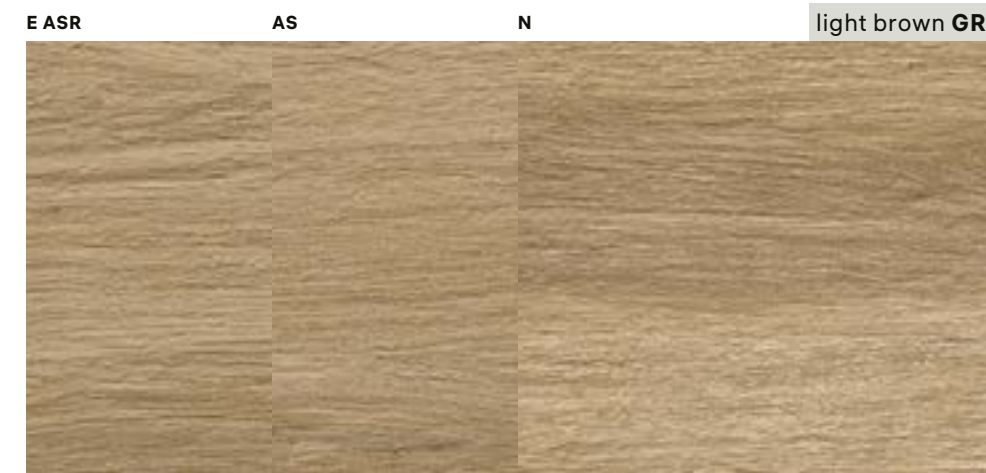

| | | | | |
|-----------------|-----|----|-----|---------|
| 20x120 . 8"x48" | 8mm | N | R10 | MG-1220 |
| | 8mm | AS | R11 | MG-1245 |

| | | | | |
|------------------|------|-------|-----|---------|
| 20x120 . 8"x48" | 8mm | N | R10 | MG-1220 |
| 40x120 . 16"x48" | 20mm | E ASR | R11 | MG-7290 |

| | | | | |
|-----------------|-----|---|-----|---------|
| 20x120 . 8"x48" | 8mm | N | R10 | MG-1220 |
|-----------------|-----|---|-----|---------|

laying suggestions

suggestions de pose . anwendungsvorschläge . sugestões de aplicação

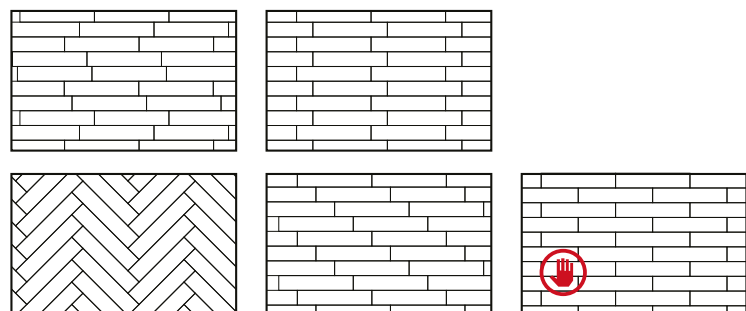

special pieces

pièces spéciales . spezialteile . peças especiais

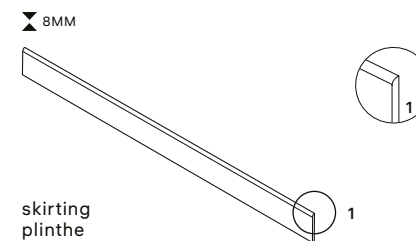

skirting
plinthe
sockel
rodapé boleado
8x120 . 3,2"x 48"
N MP-6200

Available in all colours
Disponible dans toutes les couleurs
Erhältlich in allen Farben
Disponível em todas as cores

OUTDOOR
EXTRA THICK

Special 20MM pieces please refer to page 320.
Pièces spéciales 20MM, veuillez consulter la page 320.
Speziellanfertigungen 20MM siehe Seite 320.
Peças especiais 20MM, por favor consulte a página 320.

index

colour map

collections

concept

endless

evoke

grove

hybrid

jungle

metropolis

natural

prestige

pure stone

slabstone

stage

subway

tecnica

time 2.0

tool

linea collections

useful information



light grey TL2 45x90 A

LAMINATED
PORCELAIN
STONEWARE

FULL BODY
PORCELAIN

tool

collection

↓
DOWNLOAD
CATALOGUE

↓
DOWNLOAD
CATALOGUE
OUTDOOR
EXTRA THICK

↓
DOWNLOAD
TECHNICAL
FEATURES

🌐
VIEW
ONLINE



120x260
NR 6mm

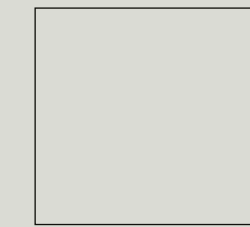

120x120
NR 6mm

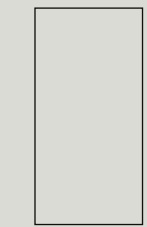

60x120
NR 6mm

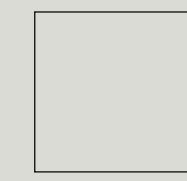

90x90
NR 9,5mm
A 9,5mm
ASR 9,5mm



45x90
NR 9mm
A 9mm

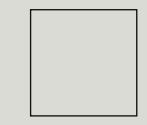

60x60
NR 8,5mm
TC 8,5mm
A 8,5mm
E ASR 20mm

rectified products . produits rectifiés . rektifizierte produkte . produtos retificados



white
TL1 . LTL1

light grey
TL2 . LTL2

tortora
TL3 . LTL3

grey
TL4 . LTL4

UGL V3 R11 R10 R9
ASR NR LINEA



PROTECT
Antibacterial for Life.

pour plus d'informations, consultez
<https://evaluation.cstb.fr>

MARGRES
CERAMIC TILES

index

colour map

collections

concept

endless

evoke

grove

hybrid

jungle

metropolis

natural

prestige

pure stone

slabstone

stage

subway

tecnica

time 2.0

tool

linea collections

useful information



164

general catalogue . 2024

mosaic hexagon tool white 24x26,6 NR



165

general catalogue . 2024

white TL1 45x90 NR

- concept
- endless
- evoke
- grove
- hybrid
- jungle
- metropolis
- natural
- prestige
- pure stone
- slabstone
- stage
- subway
- tecnica
- time 2.0



166

general catalogue . 2024

tortora TL3 90x90 NR

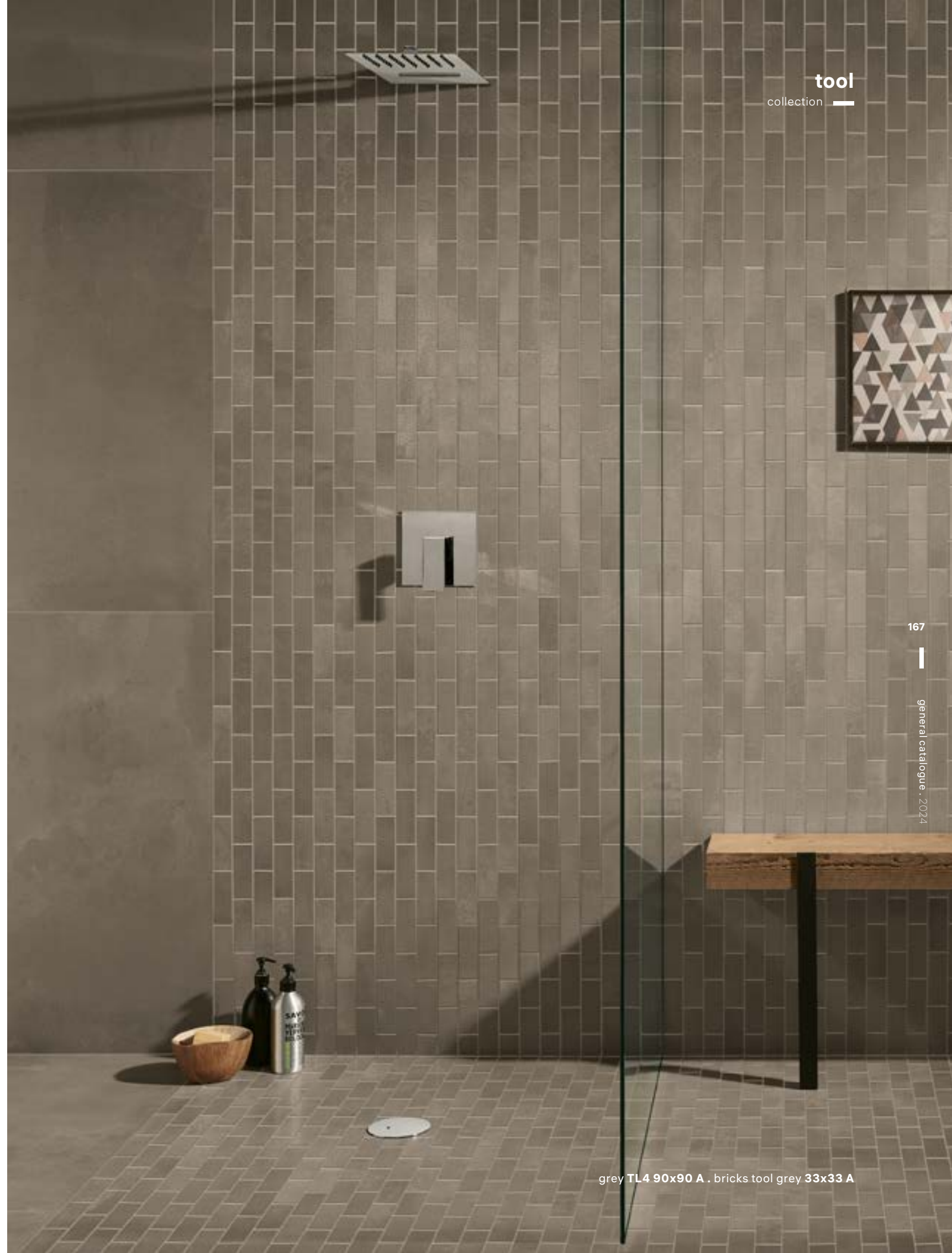

167

general catalogue . 2024

grey TL4 90x90 A . bricks tool grey 33x33 A

index

colour map

collections

concept

endless

evoke

grove

hybrid

jungle

metropolis

natural

prestige

pure stone

slabstone

stage

subway

tecnica

time 2.0

tool

linea collections

useful information

light grey TL2 90x90 ASR



grey TL4 60x60 E ASR

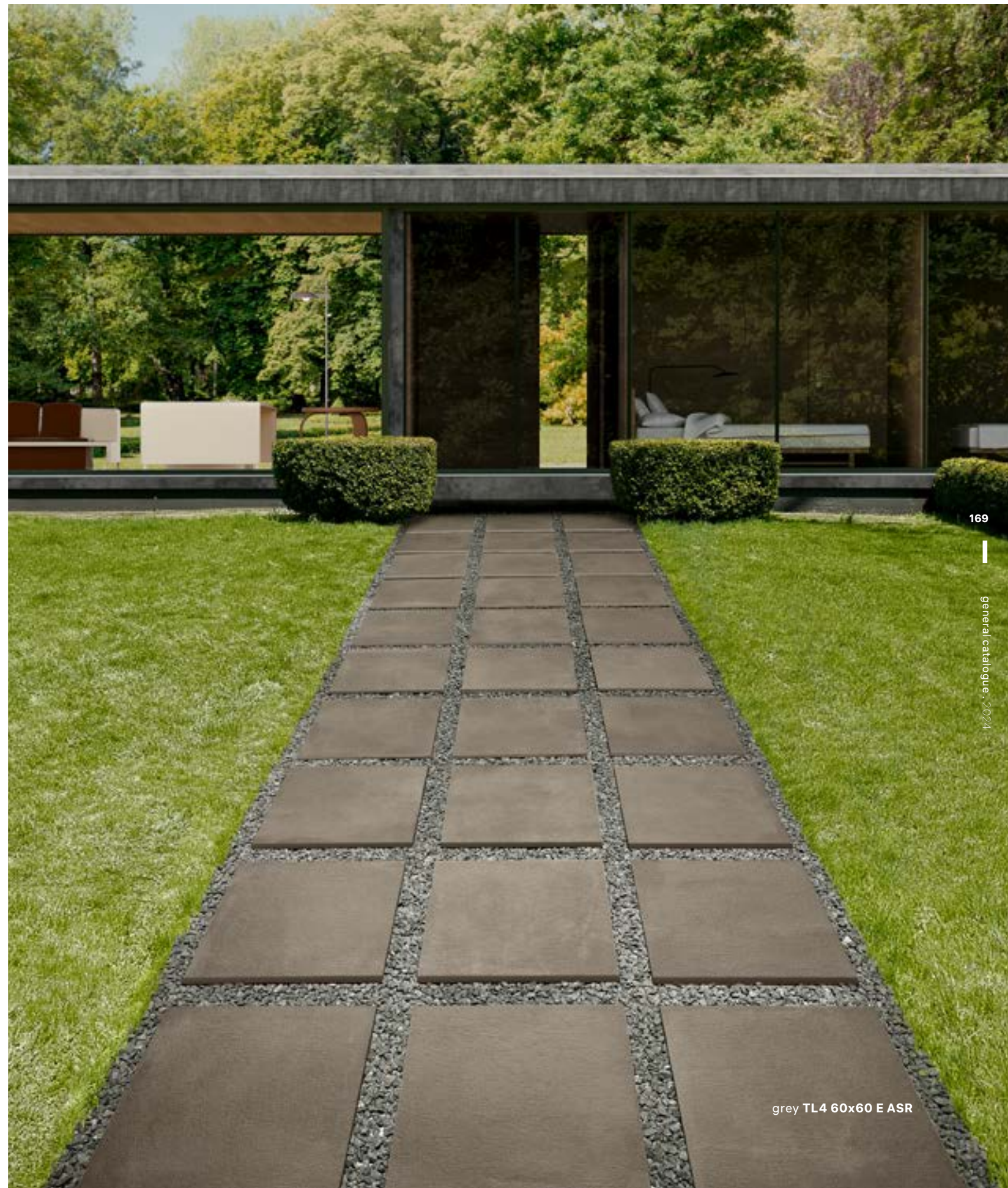

tool

collection

white TL1 . LTL1 A TC NR E ASR



| | | | | |
|-----------------|-------|-------|-----|---------|
| 60x60 . 24"x24" | 8,5mm | NR | R10 | MG-2765 |
| | 8,5mm | TC | - | MG-2765 |
| | 8,5mm | A | - | MG-3080 |
| | 20mm | E ASR | R11 | MG-7090 |
| 45x90 . 18"x36" | 9mm | NR | R10 | MG-3560 |
| | 9mm | A | - | MG-3730 |
| 90x90 . 36"x36" | 9,5mm | NR | R10 | MG-3960 |
| | 9,5mm | A | - | MG-4290 |

LINEA

| | | | | |
|--------------------|-----|----|----|---------|
| 60x120 . 24"x48" | 6mm | NR | R9 | M3-5730 |
| 120x120 . 48"x48" | 6mm | NR | R9 | M3-6730 |
| 120x260 . 48"x102" | 6mm | NR | R9 | M3-8230 |

tortora TL3 . LTL3 A TC NR E ASR



| | | | | |
|-----------------|-------|-------|-----|---------|
| 60x60 . 24"x24" | 8,5mm | NR | R10 | MG-2765 |
| | 8,5mm | TC | - | MG-2765 |
| | 8,5mm | A | - | MG-3080 |
| | 20mm | E ASR | R11 | MG-7090 |
| 45x90 . 18"x36" | 9mm | NR | R10 | MG-3560 |
| | 9mm | A | - | MG-3730 |
| 90x90 . 36"x36" | 9,5mm | NR | R10 | MG-3960 |
| | 9,5mm | A | - | MG-4290 |

LINEA

| | | | | |
|--------------------|-----|----|----|---------|
| 60x120 . 24"x48" | 6mm | NR | R9 | M3-5730 |
| 120x120 . 48"x48" | 6mm | NR | R9 | M3-6730 |
| 120x260 . 48"x102" | 6mm | NR | R9 | M3-8230 |

tool

collection

ASR . E ASR NR TC A light grey TL2 . LTL2



| | | | | |
|-----------------|-------|-------|-----|---------|
| 60x60 . 24"x24" | 8,5mm | NR | R10 | MG-2765 |
| | 8,5mm | TC | - | MG-2765 |
| | 8,5mm | A | - | MG-3080 |
| | 20mm | E ASR | R11 | MG-7090 |
| 45x90 . 18"x36" | 9mm | NR | R10 | MG-3560 |
| | 9mm | A | - | MG-3730 |
| 90x90 . 36"x36" | 9,5mm | NR | R10 | MG-3960 |
| | 9,5mm | A | - | MG-4290 |
| | 9,5mm | ASR | R11 | MG-3960 |

LINEA

| | | | | |
|--------------------|-----|----|----|---------|
| 60x120 . 24"x48" | 6mm | NR | R9 | M3-5730 |
| 120x120 . 48"x48" | 6mm | NR | R9 | M3-6730 |
| 120x260 . 48"x102" | 6mm | NR | R9 | M3-8230 |

ASR . E ASR NR TC A grey TL4 . LTL4



| | | | | |
|-----------------|-------|-------|-----|---------|
| 60x60 . 24"x24" | 8,5mm | NR | R10 | MG-2765 |
| | 8,5mm | TC | - | MG-2765 |
| | 8,5mm | A | - | MG-3080 |
| | 20mm | E ASR | R11 | MG-7090 |
| 45x90 . 18"x36" | 9mm | NR | R10 | MG-3560 |
| | 9mm | A | - | MG-3730 |
| 90x90 . 36"x36" | 9,5mm | NR | R10 | MG-3960 |
| | 9,5mm | A | - | MG-4290 |
| | 9,5mm | ASR | R11 | MG-3960 |

LINEA

| | | | | |
|--------------------|-----|----|----|---------|
| 60x120 . 24"x48" | 6mm | NR | R9 | M3-5730 |
| 120x120 . 48"x48" | 6mm | NR | R9 | M3-6730 |
| 120x260 . 48"x102" | 6mm | NR | R9 | M3-8230 |

index

colour map

collections

concept

endless

evoke

grove

hybrid

jungle

metropolis

natural

prestige

pure stone

slabstone

stage

subway

tecnica

time 2.0

tool

linea collections

useful information

PROTECT

Antibacterial for Life.

An exclusive line of extremely high performance antimicrobial floor and wall tiles, designed for healthy, safe and protected living spaces. Available only in Linea Range.
 Une ligne exclusive de sols et revêtements antibactériens aux performances très élevées, pour un habitat sain, sûr et protégé. Disponible uniquement dans la gamme Linea.
 Eine exklusive Linie an hochwertigen Fußböden und antibakteriellen Wandverkleidungen, für ein gesundes, sicheres und geschütztes Leben. Nur in der Linea Serie erhältlich.
 Uma linha exclusiva de pavimentos e revestimentos antimicrobianos de altíssima performance, projetada para ambientes saudáveis, seguros e protegidos. Disponível unicamente na gama Linea.

MARGRES
CERAMIC TILES

tool

collection

decors

décorations . dekorationen . decorações

8,5MM

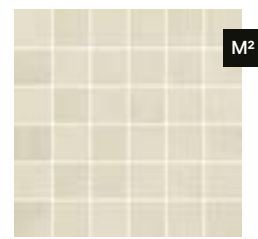

mosaic tool 5x5 white
30x30 . 12"x12"
NR MG-9570

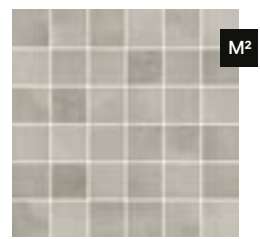

mosaic tool 5x5 light grey
30x30 . 12"x12"
NR MG-9570



mosaic tool 5x5 tortora
30x30 . 12"x12"
NR MG-9570



mosaic tool 5x5 grey
30x30 . 12"x12"
NR MG-9570

8,5MM



bricks tool white
33x33 . 13"x13"
NR MG-9570
A MG-9745



bricks tool light grey
33x33 . 13"x13"
NR MG-9570
A MG-9745



bricks tool tortora
33x33 . 13"x13"
NR MG-9570
A MG-9745



bricks tool grey
33x33 . 13"x13"
NR MG-9570
A MG-9745

8,5MM



mosaic hexagon tool white
24x26,6 . 9"x10"
NR MG-9660



mosaic hexagon tool light grey
24x26,6 . 9"x10"
NR MG-9660



mosaic hexagon tool tortora
24x26,6 . 9"x10"
NR MG-9660



mosaic hexagon tool grey
24x26,6 . 9"x10"
NR MG-9660

8,5MM



barra tool
(all colours)
10x60 . 4"x24"
NR . A MP-6080

Mosaic and Brick decors are net mounted. All decors may feature shade variations regarding the corresponding floor/wall tile standard tile.
Les décorations Mosaic et Brick sont sur trame. Toutes les décorations peuvent souffrir variations de tonalité par rapport aux carreaux base.
Die Mosaic und Brick Dekoration liegen auf einem Netz. Alle Dekorationen können im Vergleich zu den jeweiligen Grundiesen Farbunterschiede aufweisen.
As decorações Mosaic and Brick são sobre rede. Todas as decorações podem sofrer variações de tonalidade em relação aos respectivos mosaicos base.

MARGRES
CERAMIC TILES

special pieces

pièces spéciales . spezialteile . peças especiais

9,5 . 8,5MM

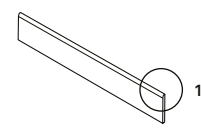

skirting
plinthe
sockel
rodapé boleado

8x60 . 3,2"x24"
NR . TC MP-6170
A MP-6180
8x90 . 3,2"x36"
NR MP-6260
A MP-6270

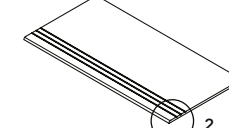
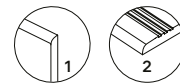

step tread grooved
nez de marche creusé
stufenplatte mit rillen
degrau sulcado

30x60 . 12"x24"
NR . TC MP-6240
A MP-6270
30x90 . 12"x36"
NR_ASR* MP-6430
A MP-6445

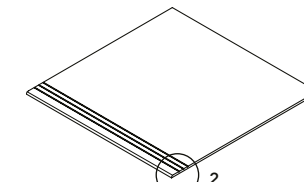

step tread grooved
nez de marche creusé
stufenplatte mit rillen
degrau sulcado

60x60 . 24"x24"
NR . TC MP-6400
A MP-6430

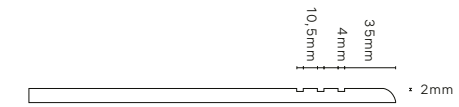

8,5MM

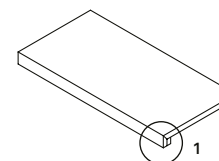

step extra thick
nez de marche forte épaisseur
massive stufenplatte
degrau espessurado

30x60 . 12"x24"
NR . TC . A MP-6560

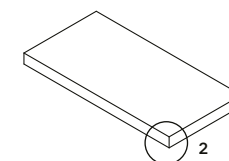
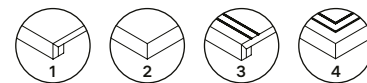

step extra thick corner**
nez de marche forte épaisseur angle**
ecke massive stufenplatte**
degrau espessurado canto**

30x60 . 12"x24"
NR . TC . A MP-6630

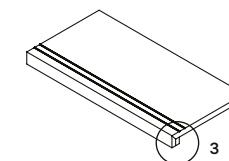

step extra thick inox
nez de marche forte épaisseur inox
massive stufenplatte inox
degrau espessurado inox

30x60 . 12"x24"
NR . TC . A MP-6580

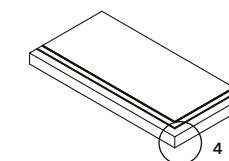

step extra thick corner inox**
nez de marche forte épaisseur angle inox**
ecke massive stufenplatte inox**
degrau espessurado canto inox**

30x60 . 12"x24"
NR . TC . A MP-6650



step extra thick corner . nez de marche forte épaisseur angle
ecke massive stufenplatte . degrau espessurado canto

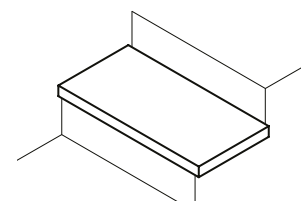

right corner . angle droit
rechten ecke . canto direito

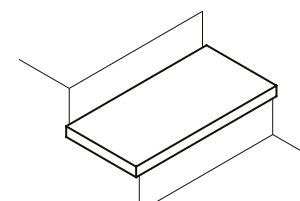

left corner . angle gauche
links ecke . canto esquerdo

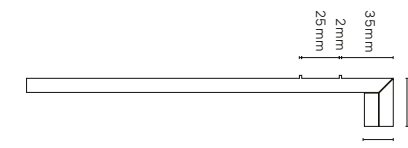

step extra thick corner inox . nez de marche forte épaisseur angle inox
ecke massive stufenplatte inox . degrau espessurado canto inox

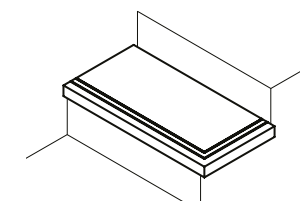

right corner . angle droit
rechten ecke . canto direito

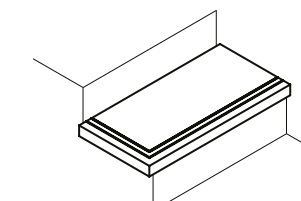

left corner . angle gauche
links ecke . canto esquerdo

Available in all colours
Disponible dans toutes les couleurs
Erhältlich in allen Farben
Disponível em todas as cores

*Available only in colours Light Grey and Grey
*Disponible uniquement dans les couleurs Light Grey et Grey
*Nur in den Farben Light Grey und Grey verfügbar
*Disponível unicamente nas cores Light Grey e Grey

**Available in right and left corner
**Disponible dans les coin droit et gauche
**Erhältlich in der rechten Ecke und links
**Disponível no canto direito e esquerdo

OUTDOOR
EXTRA THICK
Special 20MM pieces please refer to page 320.
Pièces spéciales 20MM, veuillez consulter la page 320.
Speziellanfertigungen 20MM siehe Seite 320.
Peças especiais 20MM, por favor consulte a página 320.

index

colour map

collections

concept

endless

evoke

grove

hybrid

jungle

metropolis

natural

prestige

pure stone

slabstone

stage

subway

tecnica

time 2.0

tool

linea collections

useful information



grey SL5 60x60 NR

LAMINATED
PORCELAIN
STONEWARE

FULL BODY
PORCELAIN

slabstone

collection

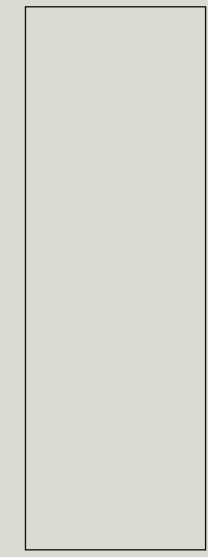

100x300
NR 3,5mm

↓
DOWNLOAD
CATALOGUE

↓
DOWNLOAD
TECHNICAL
FEATURES

↓
VIEW
ONLINE

↓
DOWNLOAD
CATALOGUE
OUTDOOR
EXTRA THICK

↓
DOWNLOAD
BIM

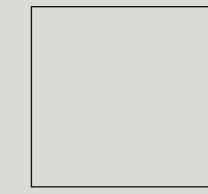

100x100
NR 3,5mm

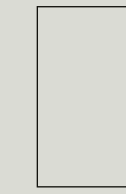

50x100
NR 3,5mm

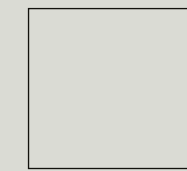

90x90
NR 9,5mm
ASR 9,5mm



45x90
NR 9mm

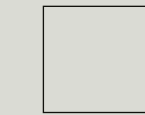

60x60
NR 8,5mm
A 8,5mm
ASR 8,5mm
E ASR 20mm



30x60
NR 8,5mm

rectified products . produits rectifiés . rektifizierter produkte . produtos retificados



white
SL1 . LSL1

beige
SL2 . LSL2

tortora
SL3 . LSL3

light grey
SL4 . LSL4

grey
SL5 . LSL5

UGL V2 R11 R10 R9 LINEA LINEA



pour plus d'informations, consultez
<https://evaluation.cstb.fr>

PR()TECT®
Antibacterial for Life.

MARGRES
CERAMIC TILES

index

colour map

collections

- concept
- endless
- evoke
- grove
- hybrid
- jungle
- metropolis
- natural
- prestige
- pure stone
- slabstone**
- stage
- subway
- tecnica
- time 2.0
- tool

linea collections

useful information



slabstone
collection



178

general catalogue . 2024



179

general catalogue . 2024

slabstone
collection

index

colour map

collections

concept

endless

evoke

grove

hybrid

jungle

metropolis

natural

prestige

pure stone

slabstone

stage

subway

tecnica

time 2.0

tool

linea collections

useful information

beige SL2 90x90 NR



light grey SL4 45x90 NR . 90x90 NR



beige SL2 60x60 E ASR

index

colour map

collections

concept

endless

evoke

grove

hybrid

jungle

metropolis

natural

prestige

pure stone

slabstone

stage

subway

tecnica

time 2.0

tool

linea collections

useful information

general catalogue . 2024

181 | general catalogue . 2024

slabstone
collection

white SL1 . LSL1 A NR ASR . E ASR



| | | | | |
|-----------------|-------|-------|-----|---------|
| 30x60 . 12"x24" | 8,5mm | NR | R10 | MG-2070 |
| | 8,5mm | NR | R10 | MG-2780 |
| 60x60 . 24"x24" | 8,5mm | A | - | MG-3095 |
| | 8,5mm | ASR | R11 | MG-2780 |
| | 20mm | E ASR | R11 | MG-7090 |
| 45x90 . 18"x36" | 9mm | NR | R10 | MG-3580 |
| 90x90 . 36"x36" | 9,5mm | NR | R10 | MG-3970 |
| | 9,5mm | ASR | R11 | MG-3970 |

LINEA

| | | | | |
|-----------------------|-------|----|----|---------|
| 50x100 . 19,6"x39,4" | 3,5mm | NR | R9 | M3-0930 |
| 100x100 . 39,4"x39,4" | 3,5mm | NR | R9 | M3-1230 |
| 100x300 . 39,4"x118" | 3,5mm | NR | R9 | M3-1530 |

beige SL2 . LSL2 A NR ASR . E ASR



| | | | | |
|-----------------|-------|-------|-----|---------|
| 30x60 . 12"x24" | 8,5mm | NR | R10 | MG-2070 |
| | 8,5mm | NR | R10 | MG-2780 |
| 60x60 . 24"x24" | 8,5mm | A | - | MG-3095 |
| | 8,5mm | ASR | R11 | MG-2780 |
| | 20mm | E ASR | R11 | MG-7090 |
| 45x90 . 18"x36" | 9mm | NR | R10 | MG-3580 |
| 90x90 . 36"x36" | 9,5mm | NR | R10 | MG-3970 |
| | 9,5mm | ASR | R11 | MG-3970 |

LINEA

| | | | | |
|-----------------------|-------|----|----|---------|
| 50x100 . 19,6"x39,4" | 3,5mm | NR | R9 | M3-0930 |
| 100x100 . 39,4"x39,4" | 3,5mm | NR | R9 | M3-1230 |
| 100x300 . 39,4"x118" | 3,5mm | NR | R9 | M3-1530 |

tortora SL3 . LSL3 A NR ASR . E ASR



| | | | | |
|-----------------|-------|-------|-----|---------|
| 30x60 . 12"x24" | 8,5mm | NR | R10 | MG-2070 |
| | 8,5mm | NR | R10 | MG-2780 |
| 60x60 . 24"x24" | 8,5mm | A | - | MG-3095 |
| | 8,5mm | ASR | R11 | MG-2780 |
| | 20mm | E ASR | R11 | MG-7090 |
| 45x90 . 18"x36" | 9mm | NR | R10 | MG-3580 |
| 90x90 . 36"x36" | 9,5mm | NR | R10 | MG-3970 |
| | 9,5mm | ASR | R11 | MG-3970 |

LINEA

| | | | | |
|-----------------------|-------|----|----|---------|
| 50x100 . 19,6"x39,4" | 3,5mm | NR | R9 | M3-0930 |
| 100x100 . 39,4"x39,4" | 3,5mm | NR | R9 | M3-1230 |
| 100x300 . 39,4"x118" | 3,5mm | NR | R9 | M3-1530 |

slabstone
collection

light grey SL4 . LSL4 ASR . E ASR NR A



| | | | | |
|-----------------|-------|-------|-----|---------|
| 30x60 . 12"x24" | 8,5mm | NR | R10 | MG-2070 |
| | 8,5mm | NR | R10 | MG-2780 |
| 60x60 . 24"x24" | 8,5mm | A | - | MG-3095 |
| | 8,5mm | ASR | R11 | MG-2780 |
| | 20mm | E ASR | R11 | MG-7090 |
| 45x90 . 18"x36" | 9mm | NR | R10 | MG-3580 |
| 90x90 . 36"x36" | 9,5mm | NR | R10 | MG-3970 |
| | 9,5mm | ASR | R11 | MG-3970 |

LINEA

| | | | | |
|-----------------------|-------|----|----|---------|
| 50x100 . 19,6"x39,4" | 3,5mm | NR | R9 | M3-0930 |
| 100x100 . 39,4"x39,4" | 3,5mm | NR | R9 | M3-1230 |
| 100x300 . 39,4"x118" | 3,5mm | NR | R9 | M3-1530 |

grey SL5 . LSL5 ASR . E ASR NR A



| | | | | |
|-----------------|-------|-------|-----|---------|
| 30x60 . 12"x24" | 8,5mm | NR | R10 | MG-2070 |
| | 8,5mm | NR | R10 | MG-2780 |
| 60x60 . 24"x24" | 8,5mm | A | - | MG-3095 |
| | 8,5mm | ASR | R11 | MG-2780 |
| | 20mm | E ASR | R11 | MG-7090 |
| 45x90 . 18"x36" | 9mm | NR | R10 | MG-3580 |
| 90x90 . 36"x36" | 9,5mm | NR | R10 | MG-3970 |
| | 9,5mm | ASR | R11 | MG-3970 |

LINEA

| | | | | |
|-----------------------|-------|----|----|---------|
| 50x100 . 19,6"x39,4" | 3,5mm | NR | R9 | M3-0930 |
| 100x100 . 39,4"x39,4" | 3,5mm | NR | R9 | M3-1230 |
| 100x300 . 39,4"x118" | 3,5mm | NR | R9 | M3-1530 |

index

colour map

collections

concept

endless

evoke

grove

hybrid

jungle

metropolis

natural

prestige

pure stone

slabstone

stage

subway

tecnica

time 2.0

tool

linea collections

useful information

PROTECT®

Antibacterial for Life.

An exclusive line of extremely high performance antimicrobial floor and wall tiles, designed for healthy, safe and protected living spaces. Available only in Linea Range.

Une ligne exclusive de sols et revêtements antibactériens aux performances très élevées, pour un habitat sain, sûr et protégé. Disponible uniquement dans la gamme Linea.

Eine exklusive Linie an hochwertigen Fußböden und antibakteriellen Wandverkleidungen, für ein gesundes, sicheres und geschütztes Leben. Nur in der Linea Serie erhältlich.

Uma linha exclusiva de pavimentos e revestimentos antimicrobianos de altíssima performance, projetada para ambientes saudáveis, seguros e protegidos. Disponível unicamente na gama Linea.

MARGRES
CERAMIC TILES

slabstone

collection

decors

décorations . dekorationen . decorações

8,5MM



mosaic slabstone 3,5x3,5
white
30x30 . 12"x12"
NR MG-9590

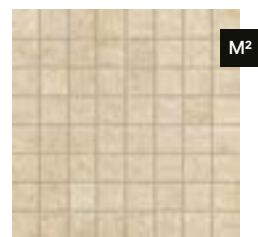

mosaic slabstone 3,5x3,5
beige
30x30 . 12"x12"
NR MG-9590



mosaic slabstone 3,5x3,5
tortora
30x30 . 12"x12"
NR MG-9590



mosaic slabstone 3,5x3,5
light grey
30x30 . 12"x12"
NR MG-9590



mosaic slabstone 3,5x3,5
grey
30x30 . 12"x12"
NR MG-9590

8,5MM



bricks slabstone white
29,6x49 . 11,7"x19,3"
NR MP-6320



bricks slabstone beige
29,6x49 . 11,7"x19,3"
NR MP-6320



bricks slabstone tortora
29,6x49 . 11,7"x19,3"
NR MP-6320



bricks slabstone light grey
29,6x49 . 11,7"x19,3"
NR MP-6320



bricks slabstone grey
29,6x49 . 11,7"x19,3"
NR MP-6320

Mosaic and Bricks decors are net mounted. All decors may feature shade variations regarding the corresponding floor/wall tile standard tile.
Les décorations Mosaic et Bricks sont sur trame. Toutes les décorations peuvent souffrir variations de tonalité par rapport aux carreaux base.
Die Mosaic und Bricks Dekoration liegen auf einem Netz. Alle Dekorationen können im Vergleich zu den jeweiligen Grundiesen Farbunterschiede aufweisen.
As decorações Mosaic e Bricks são sobre rede. Todas as decorações podem sofrer variações de tonalidade em relação aos respectivos mosaicos base.

MARGRES
CERAMIC TILES

slabstone

collection

special pieces

pièces spéciales . spezialteile . peças especiais

9,5 . 8,5MM

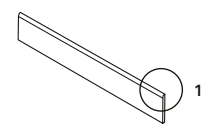

skirting
plinthe
sockel
rodapé boleado

8x60 . 3,2"x24"

NR MP-6170

A MP-6180

8x90 . 3,2"x36"

NR MP-6260

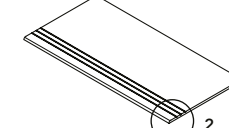
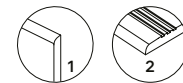

step tread grooved
nez de marche creusé
stufenplatte mit rillen
degrau sulcado

30x60 . 12"x24"

NR . ASR MP-6240

A MP-6270

30x90 . 12"x36"

NR . ASR MP-6430

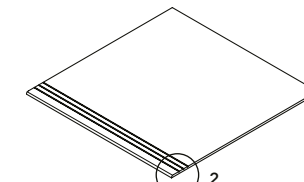

step tread grooved
nez de marche creusé
stufenplatte mit rillen
degrau sulcado

60x60 . 24"x24"

NR . ASR MP-6400

A MP-6430

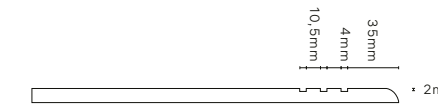

8,5MM

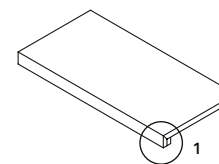

step extra thick
nez de marche forte épaisseur
massive stufenplatte
degrau espessurado

30x60 . 12"x24"

NR . A MP-6560

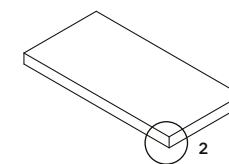
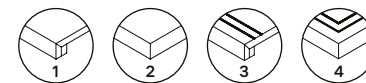

step extra thick corner*
nez de marche forte épaisseur angle*
ecke massive stufenplatte*
degrau espessurado canto*

30x60 . 12"x24"

NR . A MP-6630

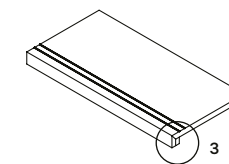

step extra thick inox
nez de marche forte épaisseur inox
massive stufenplatte inox
degrau espessurado inox

30x60 . 12"x24"

NR . A MP-6580

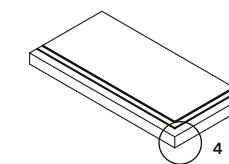

step extra thick corner inox*
nez de marche forte épaisseur angle inox*
ecke massive stufenplatte inox*
degrau espessurado canto inox*

30x60 . 12"x24"

NR . A MP-6650



step extra thick corner . nez de marche forte épaisseur angle
ecke massive stufenplatte . degrau espessurado canto

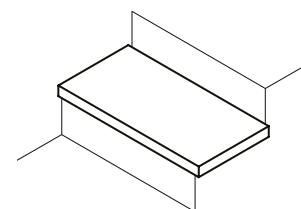

right corner . angle droit
rechten ecke . canto direito

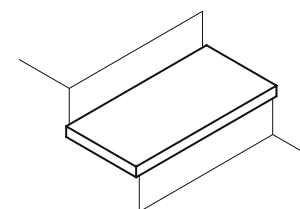

left corner . angle gauche
links ecke . canto esquerdo

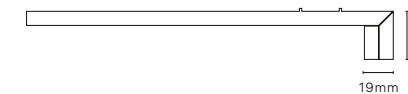

step extra thick corner inox . nez de marche forte épaisseur angle inox
ecke massive stufenplatte inox . degrau espessurado canto inox

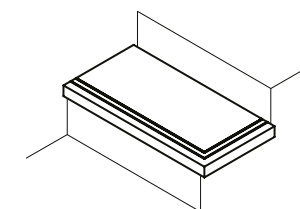

right corner . angle droit
rechten ecke . canto direito

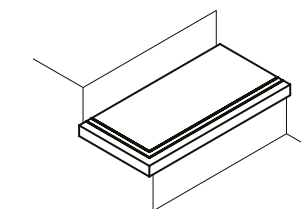

left corner . angle gauche
links ecke . canto esquerdo

OUTDOOR

EXTRA THICK

Available in all colours
Disponible dans toutes les couleurs
Erhältlich in allen Farben
Disponível em todas as cores

*Available in right and left corner
*Disponible dans les coin droit et gauche
*Erhältlich in der rechten Ecke und links
*Disponível no canto direito e esquerdo

Special 20MM pieces please refer to page 320.
Pièces spéciales 20MM, veuillez consulter la page 320.
Speziellanfertigungen 20MM siehe Seite 320.
Peças especiais 20MM, por favor consulte a página 320.

index

colour map

collections

concept

endless

evoke

grove

hybrid

jungle

metropolis

natural

prestige

pure stone

slabstone

stage

subway

tecnica

time 2.0

tool

linea collections

useful information



wenge NT6 20x90 K

DIGITEK
PORCELAIN
STONEWARE

natural

collection

↓
DOWNLOAD
CATALOGUE

↓
DOWNLOAD
TECHNICAL
FEATURES

🌐
VIEW
ONLINE



20x90
N 9mm
K 9mm
SL 9mm

non-rectified product . produit non rectifié . nicht rektifiziert produkt . produto não retificado

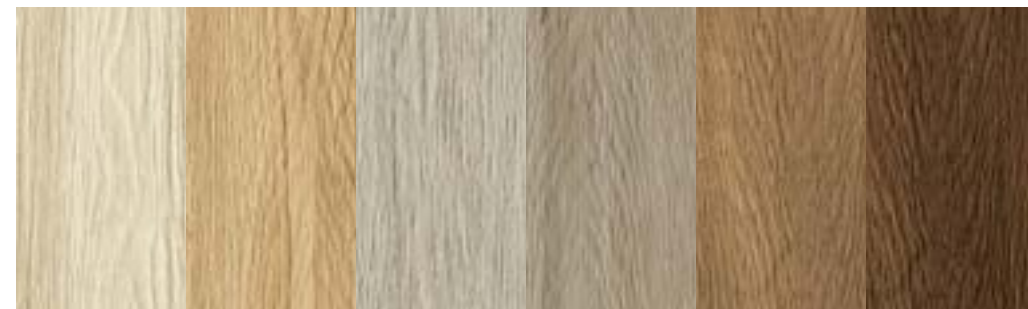

white NT1 cream NT2 grey NT3 tortora NT4 brown NT5 wenge NT6

UGL V2 R11 R9
K N.SL

MARGRES
CERAMIC TILES

index

colour map

collections

- concept
- endless
- evoke
- grove
- hybrid
- jungle
- metropolis
- natural**
- prestige
- pure stone
- slabstone
- stage
- subway
- tecnica
- time 2.0
- tool

linea collections

useful information

natural
collection

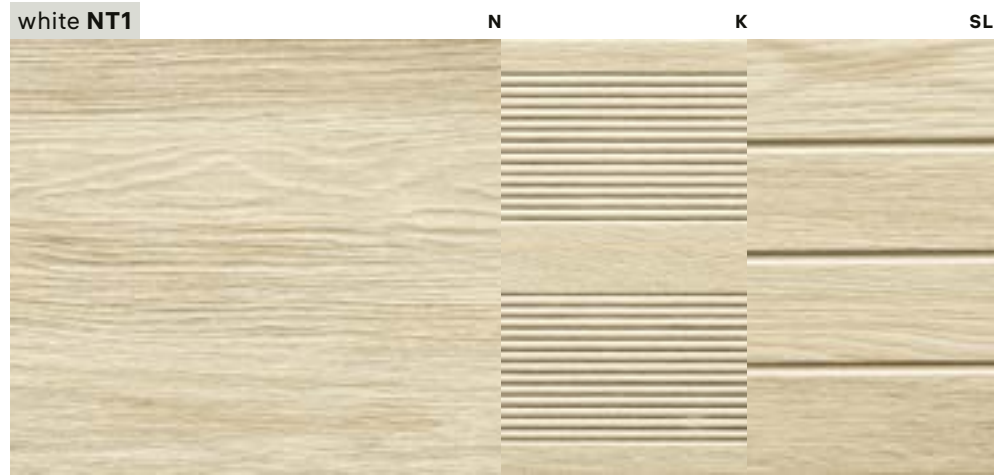

| | | | | |
|----------------|-----|-----------|-----|---------|
| 20x90 . 8"x36" | 9mm | N | R9 | MG-1130 |
| | 9mm | K | R11 | MG-1160 |
| | 9mm | SL | R9 | MG-1160 |

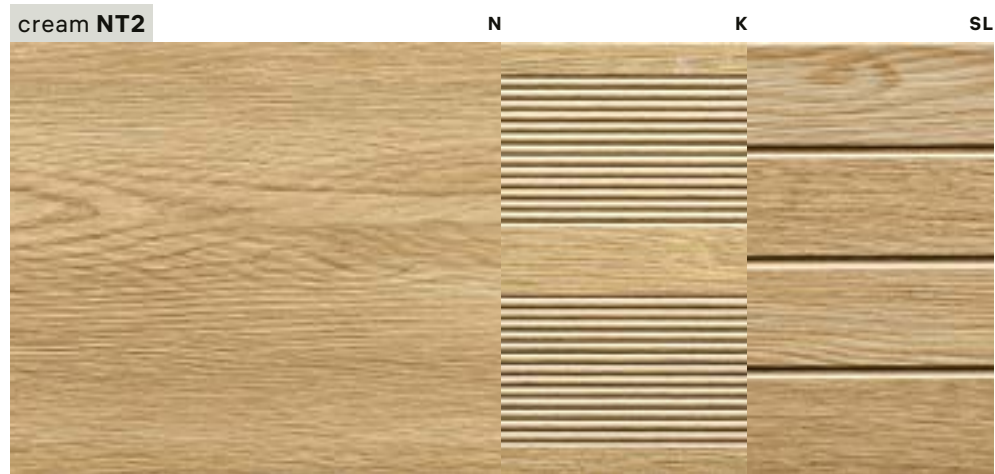

| | | | | |
|----------------|-----|-----------|-----|---------|
| 20x90 . 8"x36" | 9mm | N | R9 | MG-1130 |
| | 9mm | K | R11 | MG-1160 |
| | 9mm | SL | R9 | MG-1160 |

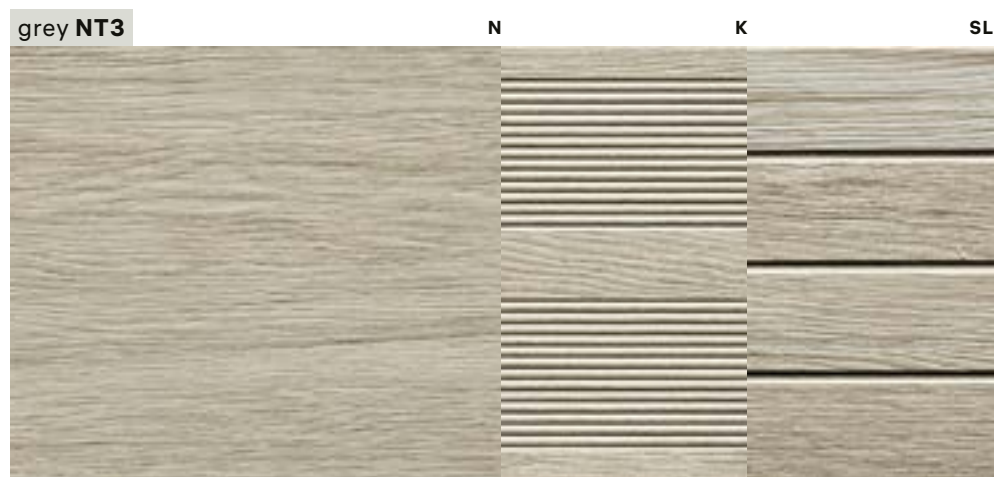

| | | | | |
|----------------|-----|-----------|-----|---------|
| 20x90 . 8"x36" | 9mm | N | R9 | MG-1130 |
| | 9mm | K | R11 | MG-1160 |
| | 9mm | SL | R9 | MG-1160 |

natural
collection

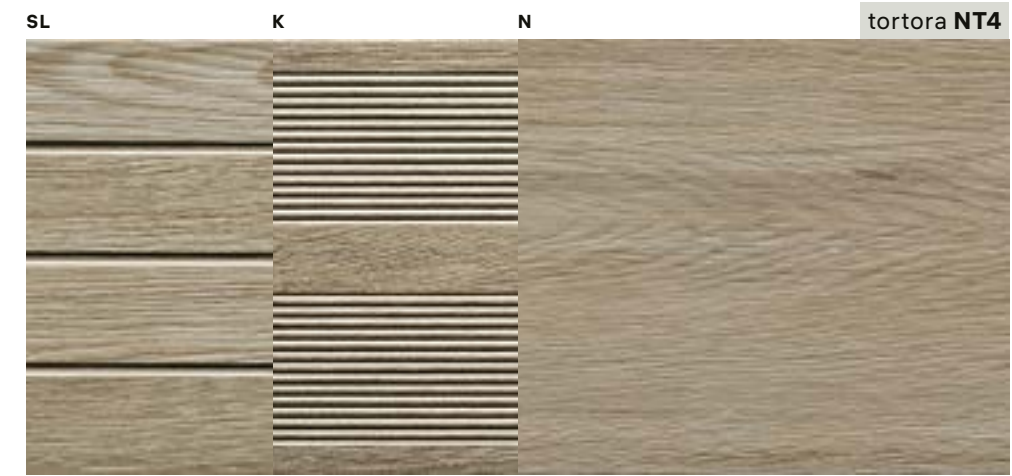

| | | | | |
|----------------|-----|-----------|-----|---------|
| 20x90 . 8"x36" | 9mm | N | R9 | MG-1130 |
| | 9mm | K | R11 | MG-1160 |
| | 9mm | SL | R9 | MG-1160 |

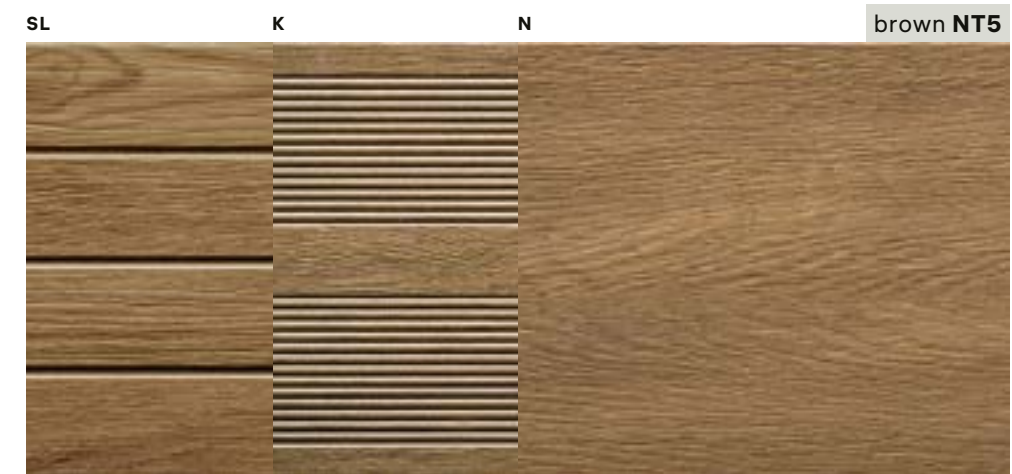

| | | | | |
|----------------|-----|-----------|-----|---------|
| 20x90 . 8"x36" | 9mm | N | R9 | MG-1130 |
| | 9mm | K | R11 | MG-1160 |
| | 9mm | SL | R9 | MG-1160 |



| | | | | |
|----------------|-----|----------|-----|---------|
| 20x90 . 8"x36" | 9mm | K | R11 | MG-1160 |
|----------------|-----|----------|-----|---------|

188
general catalogue . 2024

189
general catalogue . 2024

laying suggestions

suggestions de pose . anwendungsvorschläge . sugestões de aplicação

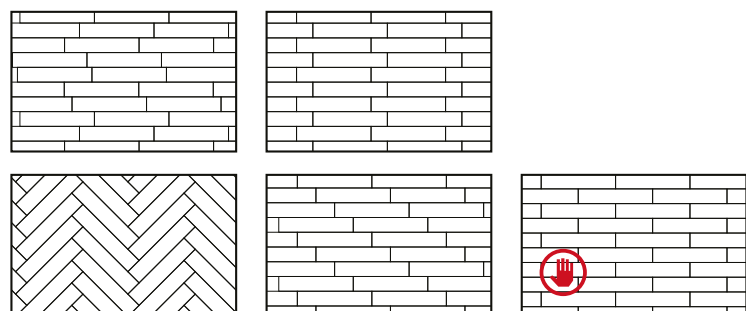

special pieces

pièces spéciales . spezialteile . peças especiais

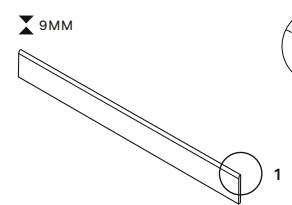

skirting
plinthe
sockel
rodapé boleado
9,5x90 . 3,8"x36"
N MP-6200

Available in all colours with the exception of Wenge
Disponible dans toutes les couleurs excepté le couleur Wenge
Erhältlich in allen Farben außer Wenge
Disponível em todas as cores exceto na cor Wenge

MARGRES
CERAMIC TILES

index

colour map

collections

concept

endless

evoke

grove

hybrid

jungle

metropolis

natural

prestige

pure stone

slabstone

stage

subway

tecnica

time 2.0

tool

linea collections

useful information



ash SW2 90x90 NR

LAMINATED
PORCELAIN
STONEWARE

FULL BODY
PORCELAIN

subway

collection



100x300
NR 3,5mm



100x100
NR 3,5mm

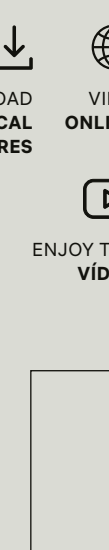

50x100
NR 3,5mm

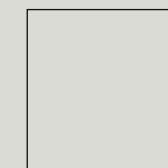

90x90
NR 9,5mm



45x90
NR 9mm



60x60
NR 8,5mm
A 8,5mm
E ASR 20mm



30x60
NR 8,5mm

↓
DOWNLOAD
CATALOGUE

↓
DOWNLOAD
TECHNICAL
FEATURES

🌐
VIEW
ONLINE

↓
DOWNLOAD
CATALOGUE
OUTDOOR
EXTRA THICK

▶
ENJOY THE
VIDEO

rectified products . produits rectifiés . rektifizierete produkte . produtos retificados



white
SW1 . LSW1

ash
SW2 . LSW2

clay
SW3 . LSW3

smoke
SW4 . LSW4

UGL V2 R10 R9 LINEA

PR()TECT®

Antibacterial for Life.

MARGRES
CERAMIC TILES

index

colour map

collections

concept

endless

evoke

grove

hybrid

jungle

metropolis

natural

prestige

pure stone

slabstone

stage

subway

tecnica

time 2.0

tool

linea collections

useful information



192



193



general catalogue . 2024

general catalogue . 2024



smoke SW4 90x90 NR

194

general catalogue . 2024



clay SW3 45x90 . 90x90 NR

195

general catalogue . 2024



ash SW2 60x60 E ASR

index

colour map

collections

concept

endless

evoke

grove

hybrid

jungle

metropolis

natural

prestige

pure stone

slabstone

stage

subway

tecnica

time 2.0

tool

linea collections

useful information

white SW1 . LSW1 A NR E ASR



| | | | | |
|-----------------|-------|-------|-----|---------|
| 30x60 . 12"x24" | 8,5mm | NR | R9 | MG-2095 |
| | 8,5mm | NR | R9 | MG-2765 |
| 60x60 . 24"x24" | 8,5mm | A | - | MG-3070 |
| | 20mm | E ASR | R10 | MG-7090 |
| 45x90 . 18"x36" | 9mm | NR | R9 | MG-3560 |
| 90x90 . 36"x36" | 9,5mm | NR | R9 | MG-3960 |

LINEA

| | | | | |
|-----------------------|-------|----|----|---------|
| 50x100 . 19,6"x39,4" | 3,5mm | NR | R9 | M3-0930 |
| 100x100 . 39,4"x39,4" | 3,5mm | NR | R9 | M3-1230 |
| 100x300 . 39,4"x118" | 3,5mm | NR | R9 | M3-1530 |

clay SW3 . LSW3 A NR E ASR



| | | | | |
|-----------------|-------|-------|-----|---------|
| 30x60 . 12"x24" | 8,5mm | NR | R9 | MG-2095 |
| | 8,5mm | NR | R9 | MG-2765 |
| 60x60 . 24"x24" | 8,5mm | A | - | MG-3070 |
| | 20mm | E ASR | R10 | MG-7090 |
| 45x90 . 18"x36" | 9mm | NR | R9 | MG-3560 |
| 90x90 . 36"x36" | 9,5mm | NR | R9 | MG-3960 |

LINEA

| | | | | |
|-----------------------|-------|----|----|---------|
| 50x100 . 19,6"x39,4" | 3,5mm | NR | R9 | M3-0930 |
| 100x100 . 39,4"x39,4" | 3,5mm | NR | R9 | M3-1230 |
| 100x300 . 39,4"x118" | 3,5mm | NR | R9 | M3-1530 |

E ASR NR A ash SW2 . LSW2



| | | | | |
|-----------------|-------|-------|-----|---------|
| 30x60 . 12"x24" | 8,5mm | NR | R9 | MG-2095 |
| | 8,5mm | NR | R9 | MG-2765 |
| 60x60 . 24"x24" | 8,5mm | A | - | MG-3070 |
| | 20mm | E ASR | R10 | MG-7090 |
| 45x90 . 18"x36" | 9mm | NR | R9 | MG-3560 |
| 90x90 . 36"x36" | 9,5mm | NR | R9 | MG-3960 |

LINEA

| | | | | |
|-----------------------|-------|----|----|---------|
| 50x100 . 19,6"x39,4" | 3,5mm | NR | R9 | M3-0930 |
| 100x100 . 39,4"x39,4" | 3,5mm | NR | R9 | M3-1230 |
| 100x300 . 39,4"x118" | 3,5mm | NR | R9 | M3-1530 |

E ASR NR A smoke SW4 . LSW4



| | | | | |
|-----------------|-------|-------|-----|---------|
| 30x60 . 12"x24" | 8,5mm | NR | R9 | MG-2095 |
| | 8,5mm | NR | R9 | MG-2765 |
| 60x60 . 24"x24" | 8,5mm | A | - | MG-3070 |
| | 20mm | E ASR | R10 | MG-7090 |
| 45x90 . 18"x36" | 9mm | NR | R9 | MG-3560 |
| 90x90 . 36"x36" | 9,5mm | NR | R9 | MG-3960 |

LINEA

| | | | | |
|-----------------------|-------|----|----|---------|
| 50x100 . 19,6"x39,4" | 3,5mm | NR | R9 | M3-0930 |
| 100x100 . 39,4"x39,4" | 3,5mm | NR | R9 | M3-1230 |
| 100x300 . 39,4"x118" | 3,5mm | NR | R9 | M3-1530 |

PROTECT

Antibacterial for Life.

An exclusive line of extremely high performance antimicrobial floor and wall tiles, designed for healthy, safe and protected living spaces. Available only in Linea Range.

Une ligne exclusive de sols et revêtements antibactériens aux performances très élevées, pour un habitat sain, sûr et protégé. Disponible uniquement dans la gamme Linea.

Eine exklusive Linie an hochwertigen Fußböden und antibakteriellen Wandverkleidungen, für ein gesundes, sicheres und geschütztes Leben. Nur in der Linea Serie erhältlich.

Uma linha exclusiva de pavimentos e revestimentos antimicrobianos de altíssima performance, projetada para ambientes saudáveis, seguros e protegidos. Disponível unicamente na gama Linea.

subway
collection

decors

décorations . dekorationen . decorações

8,5MM

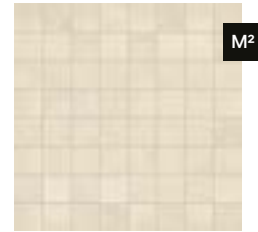

mosaic subway 3,5x3,5 white
30x30 . 12"x12"
NR MG-9590



mosaic subway 3,5x3,5 ash
30x30 . 12"x12"
NR MG-9590



mosaic subway 3,5x3,5 clay
30x30 . 12"x12"
NR MG-9590



mosaic subway 3,5x3,5 smoke
30x30 . 12"x12"
NR MG-9590

8,5MM



bricks subway white
29,6x59,5 . 11,7"x23,4"
NR MP-6350



bricks subway ash
29,6x59,5 . 11,7"x23,4"
NR MP-6350



bricks subway clay
29,6x59,5 . 11,7"x23,4"
NR MP-6350



bricks subway smoke
29,6x59,5 . 11,7"x23,4"
NR MP-6350

Mosaic and Brick decors are net mounted. All decors may feature shade variations regarding the corresponding floor/wall tile standard tile.
Les décorations Mosaic et Brick sont sur trame. Toutes les décorations peuvent souffrir variations de tonalité par rapport aux carreaux base.
Die Mosaic und Brick Dekoration liegen auf einem Netz. Alle Dekorationen können im Vergleich zu den jeweiligen Grundiesen Farbunterschiede aufweisen.
As decorações Mosaic and Brick são sobre rede. Todas as decorações podem sofrer variações de tonalidade em relação aos respectivos mosaicos base.

MARGRES
CERAMIC TILES

subway
collection

special pieces

pièces spéciales . spezialteile . peças especiais

9,5 . 8,5MM

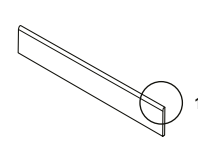

skirting
plinthe
sockel
rodapé boleado

8x60 . 3,2"x24"

NR MP-6170

A MP-6180

8x90 . 3,2"x36"

NR MP-6260

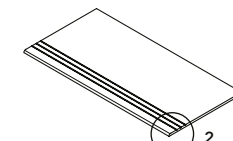
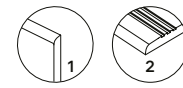

step tread grooved
nez de marche creusé
stufenplatte mit rillen
degrau sulcado

30x60 . 12"x24"

NR MP-6240

A MP-6270

30x90 . 12"x36"

NR MP-6430

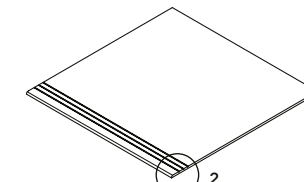

step tread grooved
nez de marche creusé
stufenplatte mit rillen
degrau sulcado

60x60 . 24"x24"

NR MP-6400

A MP-6430

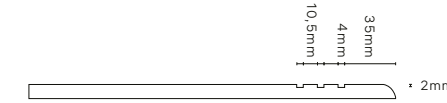

8,5MM

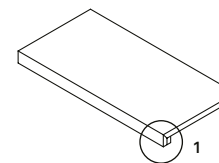

step extra thick
nez de marche forte épaisseur
massive stufenplatte
degrau espessurado

30x60 . 12"x24"

NR . A MP-6560

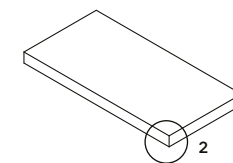
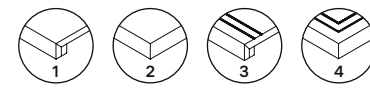

step extra thick corner*
nez de marche forte épaisseur angle*
ecke massive stufenplatte*
degrau espessurado canto*

30x60 . 12"x24"

NR . A MP-6630

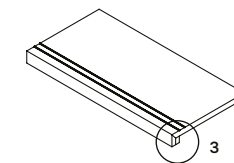

step extra thick inox
nez de marche forte épaisseur inox
massive stufenplatte inox
degrau espessurado inox

30x60 . 12"x24"

NR . A MP-6580

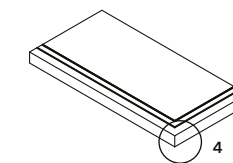

step extra thick corner inox*
nez de marche forte épaisseur angle inox*
ecke massive stufenplatte inox*
degrau espessurado canto inox*

30x60 . 12"x24"

NR . A MP-6650



step extra thick corner . nez de marche forte épaisseur angle
ecke massive stufenplatte . degrau espessurado canto

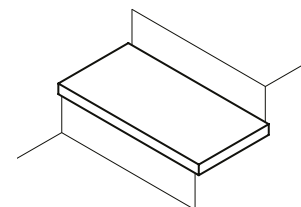

right corner . angle droit
rechten ecke . canto direito

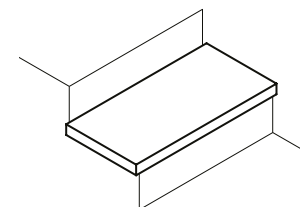

left corner . angle gauche
links ecke . canto esquerdo

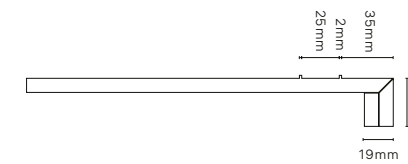

step extra thick corner inox . nez de marche forte épaisseur angle inox
ecke massive stufenplatte inox . degrau espessurado canto inox

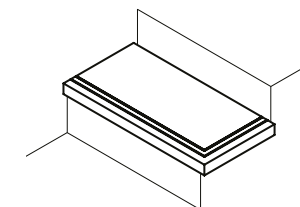

right corner . angle droit
rechten ecke . canto direito

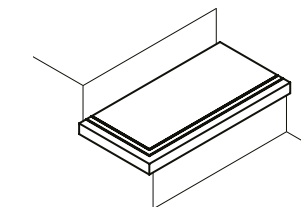

left corner . angle gauche
links ecke . canto esquerdo

OUTDOOR
EXTRA THICK

Available in all colours
Disponible dans toutes les couleurs
Erhältlich in allen Farben
Disponível em todas as cores

*Available in right and left corner
*Disponible dans les coin droit et gauche
*Erhältlich in der rechten Ecke und links
*Disponível no canto direito e esquerdo

Special 20MM pieces please refer to page 320.
Pièces spéciales 20MM, veuillez consulter la page 320.
Spezialanfertigungen 20MM siehe Seite 320.
Peças especiais 20MM, por favor consulte a página 320.

index

colour map

collections

concept

endless

evoke

grove

hybrid

jungle

metropolis

natural

prestige

pure stone

slabstone

stage

subway

tecnic

time 2.0

tool

linea collections

useful information



200

general catalogue . 2024

snow T21 60x60 P

LAMINATED
PORCELAIN
STONEWARE

TECHNICAL
FULL BODY
PORCELAIN

time 2.0

collection

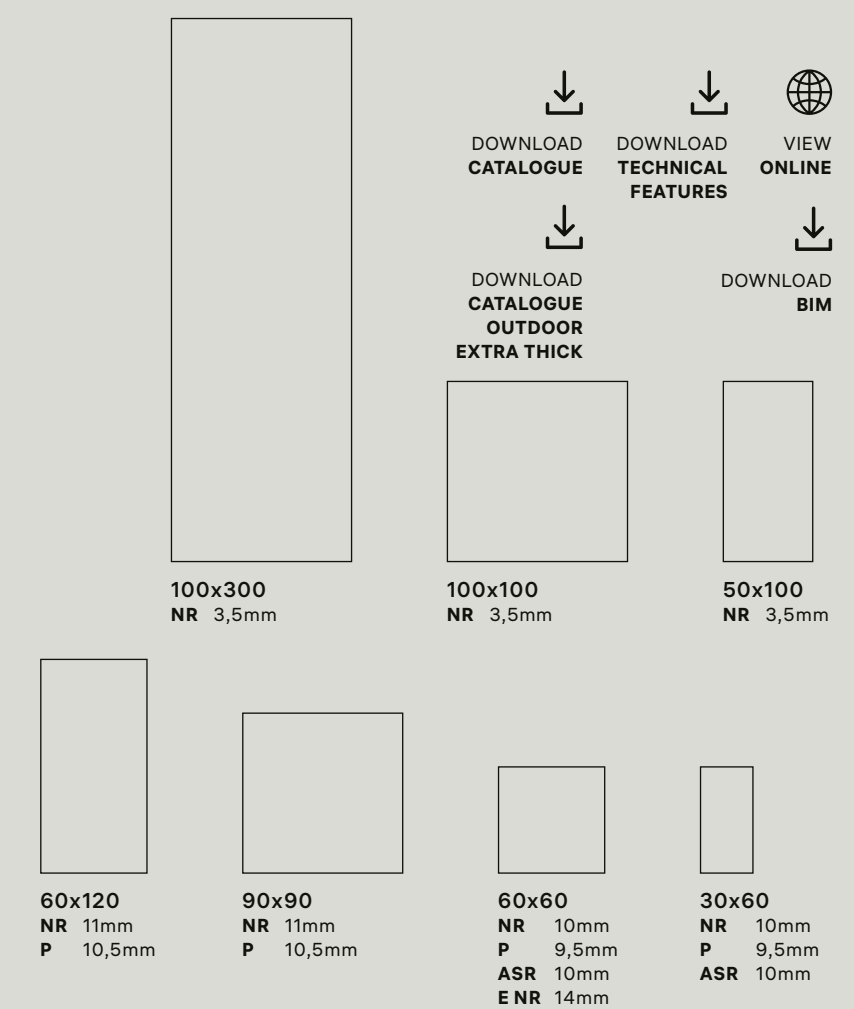

rectified products . produits rectifiés . rektifizierte produkte . produtos retificados

- ↓ DOWNLOAD CATALOGUE
- ↓ DOWNLOAD TECHNICAL FEATURES
- ↓ DOWNLOAD CATALOGUE OUTDOOR EXTRA THICK
- ↓ VIEW ONLINE
- ↓ DOWNLOAD BIM



UGL V1 R11 R10 R9 LINEA LINEA
ASR NR LINEA LINEA



PROTECT®
Antibacterial for Life.

pour plus d'informations, consultez
<https://evaluation.cstb.fr>

MARGRES
CERAMIC TILES

index

colour map

collections

- concept
- endless
- evoke
- grove
- hybrid
- jungle
- metropolis
- natural
- prestige
- pure stone
- slabstone
- stage
- subway
- tecnica
- time 2.0**
- tool

201

general catalogue . 2024

linea collections

useful information

concept

endless

evoke

grove

hybrid

jungle

metropolis

natural

prestige

pure stone

slabstone

stage

subway

tecnica

time 2.0

tool

linea collections

useful information



202

203

general catalogue, 2024

general catalogue, 2024

concept

endless

evoke

grove

hybrid

jungle

metropolis

natural

prestige

pure stone

slabstone

stage

subway

tecnica

time 2.0

tool

linea collections

useful information



204

general catalogue . 2024

205

general catalogue . 2024



206

general catalogue . 2024

black T29 60x60 P



207

general catalogue . 2024

grey T27 30x60 NR

index

colour map

collections

concept

endless

evoke

grove

hybrid

jungle

metropolis

natural

prestige

pure stone

slabstone

stage

subway

tecnica

time 2.0

tool

linea collections

useful information



208
general catalogue, 2024

silver T26 60x60 ASR



209
general catalogue, 2024

grey T27 60x60 E NR

index

colour map

collections

concept

endless

evoke

grove

hybrid

jungle

metropolis

natural

prestige

pure stone

slabstone

stage

subway

tecnica

time 2.0

tool

linea collections

useful information

snow T21 . LT21 P NR . ENR ASR



| | | | | |
|-----------------------|--------|-----|-----|---------|
| 30x60 . 12"x24" | 10mm | NR | R10 | MG-2205 |
| | 10mm | ASR | R11 | MG-2205 |
| | 9,5mm | P | - | MG-2650 |
| 60x60 . 24"x24" | 14mm | ENR | R10 | MG-3475 |
| | 10mm | NR | R10 | MG-2870 |
| | 10mm | ASR | R11 | MG-2870 |
| 90x90 . 36"x36" | 9,5mm | P | - | MG-3330 |
| | 11mm | NR | R10 | MG-4045 |
| | 10,5mm | P | - | MG-4540 |
| 60x120 . 24"x48" | 11mm | NR | R10 | MG-4805 |
| | 10,5mm | P | - | MG-5250 |
| LINEA | | | | |
| 50x100 . 19,6"x39,4" | 3,5mm | NR | R9 | M3-0930 |
| 100x100 . 39,4"x39,4" | 3,5mm | NR | R9 | M3-1230 |
| 100x300 . 39,4"x118" | 3,5mm | NR | R9 | M3-1530 |

white T22 P NR



| | | | | |
|------------------|--------|----|-----|---------|
| 30x60 . 12"x24" | 10mm | NR | R10 | MG-2105 |
| | 9,5mm | P | - | MG-2570 |
| 60x60 . 24"x24" | 10mm | NR | R10 | MG-2785 |
| | 9,5mm | P | - | MG-3250 |
| 60x120 . 24"x48" | 11mm | NR | R10 | MG-4760 |
| | 10,5mm | P | - | MG-5210 |

cream T23 . LT23 P NR . ENR ASR



| | | | | |
|-----------------------|--------|-----|-----|---------|
| 30x60 . 12"x24" | 10mm | NR | R10 | MG-2105 |
| | 10mm | ASR | R11 | MG-2105 |
| | 9,5mm | P | - | MG-2570 |
| 60x60 . 24"x24" | 14mm | ENR | R10 | MG-3425 |
| | 10mm | NR | R10 | MG-2785 |
| | 10mm | ASR | R11 | MG-2785 |
| 90x90 . 36"x36" | 9,5mm | P | - | MG-3250 |
| | 11mm | NR | R10 | MG-3985 |
| | 10,5mm | P | - | MG-4485 |
| 60x120 . 24"x48" | 11mm | NR | R10 | MG-4760 |
| | 10,5mm | P | - | MG-5210 |
| LINEA | | | | |
| 50x100 . 19,6"x39,4" | 3,5mm | NR | R9 | M3-0930 |
| 100x100 . 39,4"x39,4" | 3,5mm | NR | R9 | M3-1230 |
| 100x300 . 39,4"x118" | 3,5mm | NR | R9 | M3-1530 |

ASR NR P beige T24 . LT24



| | | | | |
|-----------------------|--------------|-----|-----|---------|
| 30x60 . 12"x24" | 10mm | NR | R10 | MG-2105 |
| | 10mm | ASR | R11 | MG-2105 |
| 60x60 . 24"x24" | 9,5mm | P | - | MG-2570 |
| | 10mm | NR | R10 | MG-2785 |
| | 10mm | ASR | R11 | MG-2785 |
| 90x90 . 36"x36" | 9,5mm | P | - | MG-3250 |
| | 11mm | NR | R10 | MG-3985 |
| 90x90 . 36"x36" | 10,5mm | P | - | MG-4485 |
| | LINEA | | | |
| 50x100 . 19,6"x39,4" | 3,5mm | NR | R9 | M3-0930 |
| 100x100 . 39,4"x39,4" | 3,5mm | NR | R9 | M3-1230 |
| 100x300 . 39,4"x118" | 3,5mm | NR | R9 | M3-1530 |

NR P dove T25



| | | | | |
|-----------------|-------|----|-----|---------|
| 30x60 . 12"x24" | 10mm | NR | R10 | MG-2105 |
| | 9,5mm | P | - | MG-2570 |
| 60x60 . 24"x24" | 10mm | NR | R10 | MG-2785 |
| | 9,5mm | P | - | MG-3250 |

Products with a polished finish are more sensitive to abrasion and stains, what requires special conditions. Please see page 328 in chapter 09.
 Les produits à finition polie sont plus sensibles à l'abrasion et aux taches, ce qui requiert des conditions particulières. Veuillez-vous consulter la page 328 du chapitre 09.
 Produkte mit einer polierten Oberfläche sind empfindlicher gegen Abrieb und Fleckenbildung, was besondere Bedingungen erfordert. Bitte beachten Sie Seite 328 in Kapitel 09.
 Os produtos com acabamento polido são mais sensíveis à abrasão e às manchas, o que requer condições especiais. Por favor consulte a página 328 no capítulo 09.

PROTECT

Antibacterial for Life.

An exclusive line of extremely high performance antimicrobial floor and wall tiles, designed for healthy, safe and protected living spaces. Available only in Linea Range.
 Une ligne exclusive de sols et revêtements antibactériens aux performances très élevées, pour un habitat sain, sûr et protégé. Disponible uniquement dans la gamme Linea.
 Eine exklusive Linie an hochwertigen Fußböden und antibakteriellen Wandverkleidungen, für ein gesundes, sicheres und geschütztes Leben. Nur in der Linea Serie erhältlich.
 Uma linha exclusiva de pavimentos e revestimentos antimicrobianos de altíssima performance, projetada para ambientes saudáveis, seguros e protegidos. Disponível unicamente na gama Linea.

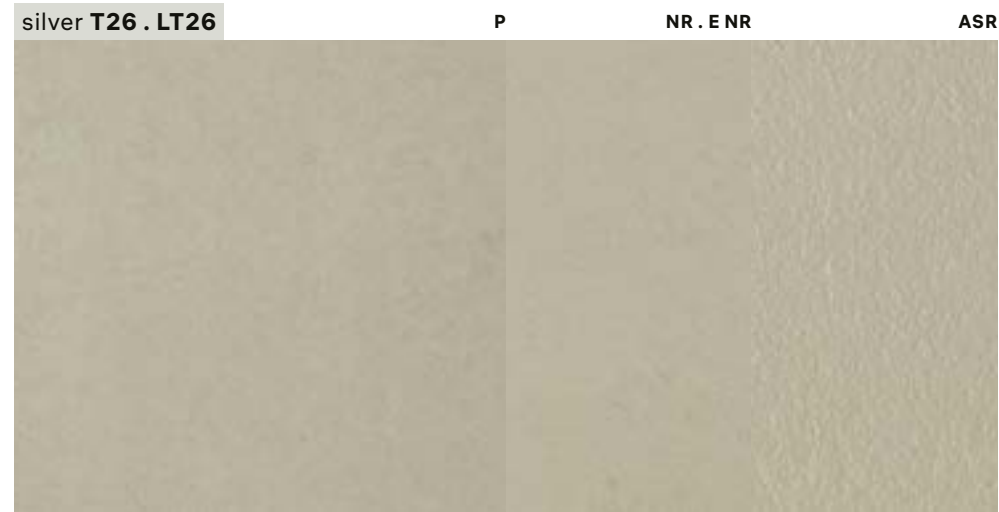

| | | | | |
|-----------------------|--------|-----|-----|---------|
| 30x60 . 12"x24" | 10mm | NR | R10 | MG-2105 |
| | 10mm | ASR | R11 | MG-2105 |
| | 9,5mm | P | - | MG-2570 |
| 60x60 . 24"x24" | 14mm | ENR | R10 | MG-3425 |
| | 10mm | NR | R10 | MG-2785 |
| | 10mm | ASR | R11 | MG-2785 |
| 90x90 . 36"x36" | 9,5mm | P | - | MG-3250 |
| | 11mm | NR | R10 | MG-3985 |
| | 10,5mm | P | - | MG-4485 |
| 60x120 . 24"x48" | 11mm | NR | R10 | MG-4760 |
| | 10,5mm | P | - | MG-5210 |
| LINEA | | | | |
| 50x100 . 19,6"x39,4" | 3,5mm | NR | R9 | M3-0930 |
| 100x100 . 39,4"x39,4" | 3,5mm | NR | R9 | M3-1230 |
| 100x300 . 39,4"x118" | 3,5mm | NR | R9 | M3-1530 |



| | | | | |
|------------------|--------|-----|-----|---------|
| 30x60 . 12"x24" | 10mm | NR | R10 | MG-2105 |
| | 9,5mm | P | - | MG-2570 |
| 60x60 . 24"x24" | 14mm | ENR | R10 | MG-3425 |
| | 10mm | NR | R10 | MG-2785 |
| | 9,5mm | P | - | MG-3250 |
| 60x120 . 24"x48" | 11mm | NR | R10 | MG-4760 |
| | 10,5mm | P | - | MG-5210 |

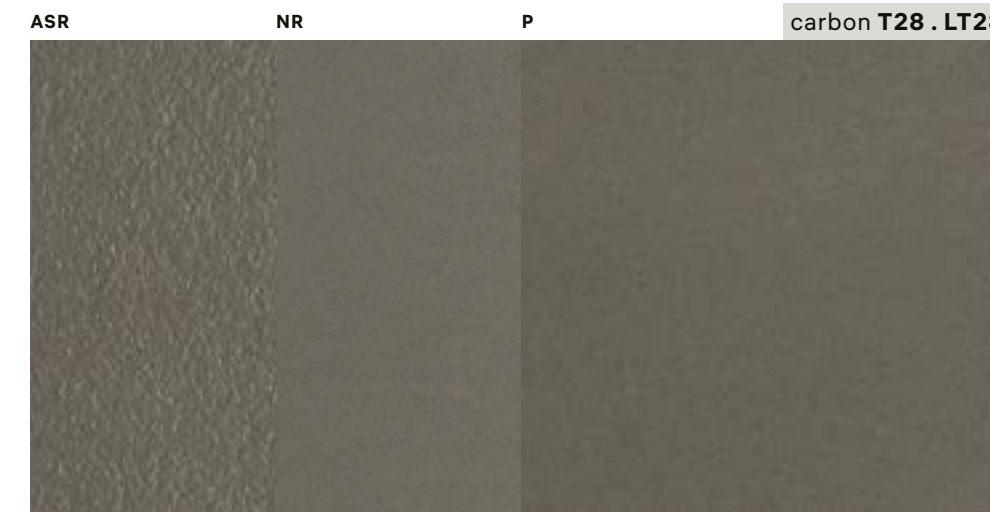

| | | | | |
|-----------------------|--------|-----|-----|---------|
| 30x60 . 12"x24" | 10mm | NR | R10 | MG-2105 |
| | 10mm | ASR | R11 | MG-2105 |
| | 9,5mm | P | - | MG-2570 |
| 60x60 . 24"x24" | 10mm | NR | R10 | MG-2785 |
| | 10mm | ASR | R11 | MG-2785 |
| | 9,5mm | P | - | MG-3250 |
| 90x90 . 36"x36" | 11mm | NR | R10 | MG-3985 |
| | 10,5mm | P | - | MG-4485 |
| LINEA | | | | |
| 50x100 . 19,6"x39,4" | 3,5mm | NR | R9 | M3-0930 |
| 100x100 . 39,4"x39,4" | 3,5mm | NR | R9 | M3-1230 |
| 100x300 . 39,4"x118" | 3,5mm | NR | R9 | M3-1530 |

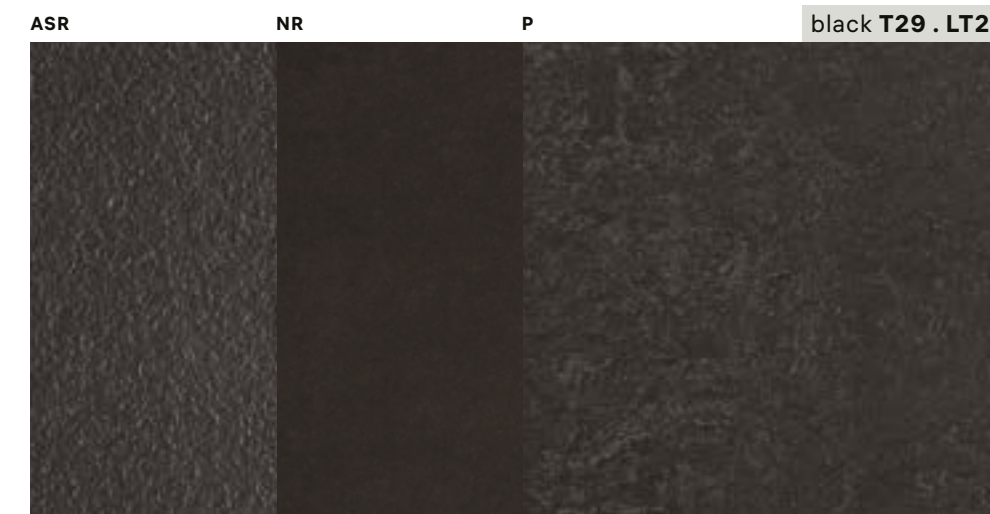

| | | | | |
|-----------------------|--------|-----|-----|---------|
| 30x60 . 12"x24" | 10mm | NR | R10 | MG-2105 |
| | 10mm | ASR | R11 | MG-2105 |
| | 9,5mm | P | - | MG-2570 |
| 60x60 . 24"x24" | 10mm | NR | R10 | MG-2785 |
| | 10mm | ASR | R11 | MG-2785 |
| | 9,5mm | P | - | MG-3250 |
| 90x90 . 36"x36" | 11mm | NR | R10 | MG-3985 |
| | 10,5mm | P | - | MG-4485 |
| 60x120 . 24"x48" | 11mm | NR | R10 | MG-4760 |
| | 10,5mm | P | - | MG-5210 |
| LINEA | | | | |
| 50x100 . 19,6"x39,4" | 3,5mm | NR | R9 | M3-0930 |
| 100x100 . 39,4"x39,4" | 3,5mm | NR | R9 | M3-1230 |
| 100x300 . 39,4"x118" | 3,5mm | NR | R9 | M3-1530 |

Products with a polished finish are more sensitive to abrasion and stains, what requires special conditions. Please see page 328 in chapter 09.
 Les produits à finition polie sont plus sensibles à l'abrasion et aux taches, ce qui requiert des conditions particulières. Veuillez-vous consulter la page 328 du chapitre 09.
 Produkte mit einer polierten Oberfläche sind empfindlicher gegen Abrieb und Fleckenbildung, was besondere Bedingungen erfordert. Bitte beachten Sie Seite 328 in Kapitel 09.
 Os produtos com acabamento polido são mais sensíveis à abrasão e às manchas, o que requer condições especiais. Por favor consulte a página 328 no capítulo 09.

PROTECT

Antibacterial for Life.

An exclusive line of extremely high performance antimicrobial floor and wall tiles, designed for healthy, safe and protected living spaces. Available only in Linea Range.
 Une ligne exclusive de sols et revêtements antibactériens aux performances très élevées, pour un habitat sain, sûr et protégé. Disponible uniquement dans la gamme Linea.
 Eine exklusive Linie an hochwertigen Fußböden und antibakteriellen Wandverkleidungen, für ein gesundes, sicheres und geschütztes Leben. Nur in der Linea Serie erhältlich.
 Uma linha exclusiva de pavimentos e revestimentos antimicrobianos de altíssima performance, projetada para ambientes saudáveis, seguros e protegidos. Disponível unicamente na gama Linea.

time 2.0

collection

decors

décorations . dekorationen . decorações

✂ P 9,5MM . NR 10MM . ASR 10MM

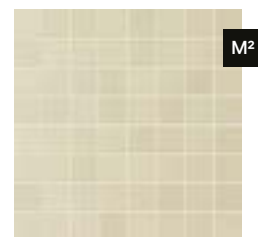

mosaic time 2.0 3,5x3,5
(all colours)
30x30 . 12"x12"
P MG-9835



mosaic time 2.0 3,5x3,5
(all colours)
30x30 . 12"x12"
NR MG-9590



mosaic time 2.0 3,5x3,5*
30x30 . 12"x12"
ASR MG-9590

✂ NR 10MM



mosaic time 2.0 3,5x10
(all colours)
30x30 . 12"x12"
NR MP-6270

- *Available in colours Snow, Cream, Beige, Silver, Carbon and Black
- *Disponible dans les couleurs Snow, Cream, Beige, Silver, Carbon et Black
- *Erhältlich in den Farben Snow, Cream, Beige, Silver, Carbon und Black
- *Disponíveis nas cores Snow, Cream, Beige, Silver, Carbon e Black

Mosaic decor is net mounted. All decors may feature shade variations regarding the corresponding floor/wall tile standard tile.
La décoration Mosaic est sur trame. Toutes les décorations peuvent souffrir variations de tonalité par rapport aux carreaux base.
Die Mosaic Dekoration ist netzverklebt. Alle Dekorationen können im Vergleich zu den jeweiligen Grundiesen Farbunterschiede aufweisen.
A decoração Mosaic é sobre rede. Todas as decorações podem sofrer variações de tonalidade em relação aos respectivos mosaicos base.

special pieces

pièces spéciales . spezialteile . peças especiais



skirting sit-in
plinthe à gorge
hohlkehlssockel
rodapé curvo
16x30 . 6,4"x12"
NR MP-6230



external corner
angle externe
aussenecke
canto externo
3,5x16 . 1,4"x6,4"
NR MP-6200

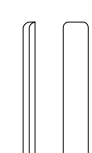

internal corner
angle interne
innenecke
canto interno
2,5x16 . 1"x6,4"
NR MP-6200

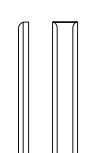

Skirting Sit-In and corners are glazed products.
La plinthe à gorge et ses angles sont des produits émaillés.
Der Hohlkehlssockel und die jeweiligen Ecken sind emailiert.
O rodapé curvo e os respectivos cantos são produtos esmaltados.

MARGRES
CERAMIC TILES

special pieces

pièces spéciales . spezialteile . peças especiais

✂ P 11 . 9,5MM . NR,ASR 11 . 10MM

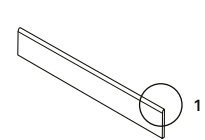

skirting
plinthe
sockel
rodapé boleado

8x60 . 3,2"x24"
NR MP-6170
P MP-6180
8x90 . 3,2"x36"
NR* MP-6260
P* MP-6270
8x120 . 3,2"x48"
NR** MP-6260
P** MP-6270

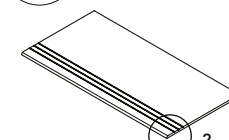
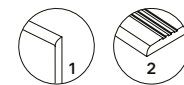

step tread grooved
nez de marche creusé
stufenplatte mit rillen
degrau sulcado

30x60 . 12"x24"
NR . ASR* MP-6240
P MP-6270
30x90 . 12"x36"
NR* MP-6430
P* MP-6445
30x120 . 12"x48"
NR** MP-6445
P** MP-6470

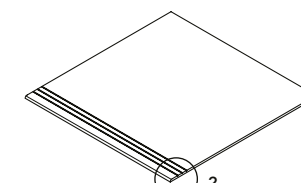

step tread grooved
nez de marche creusé
stufenplatte mit rillen
degrau sulcado

60x60 . 24"x24"
NR . ASR* MP-6400
P MP-6430



✂ P 11 . 9,5MM . NR,ASR 11 . 10MM

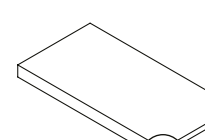

step extra thick
nez de marche forte épaisseur
massive stufenplatte
degrau espessurado

30x60 . 12"x24"
NR . P MP-6560
30x120 . 12"x48"
NR . P MP-6595

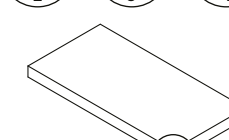

step extra thick corner***
nez de marche forte épaisseur angle***
ecke massive stufenplatte***
degrau espessurado canto***

30x60 . 12"x24"
NR . P MP-6630
30x120 . 12"x48"
NR . P MP-6655

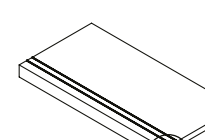

step extra thick inox
nez de marche forte épaisseur inox
massive stufenplatte inox
degrau espessurado inox

30x60 . 12"x24"
NR . P MP-6580
30x120 . 12"x48"
NR . P MP-6670

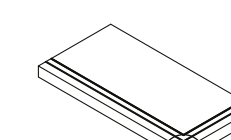

step extra thick corner inox***
nez de marche forte épaisseur angle inox***
ecke massive stufenplatte inox***
degrau espessurado canto inox***

30x60 . 12"x24"
NR . P MP-6650
30x120 . 12"x48"
NR . P MP-6710



step extra thick corner . nez de marche forte épaisseur angle
ecke massive stufenplatte . degrau espessurado canto

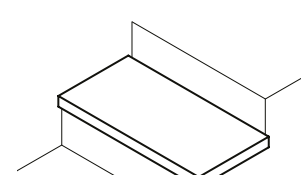

right corner . angle droit
rechten ecke . canto direito

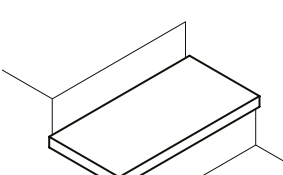

left corner . angle gauche
links ecke . canto esquerdo



step extra thick corner inox . nez de marche forte épaisseur angle inox
ecke massive stufenplatte inox . degrau espessurado canto inox

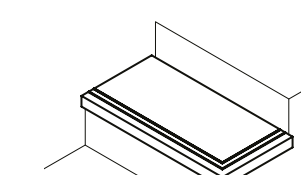

right corner . angle droit
rechten ecke . canto direito

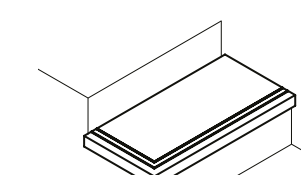

left corner . angle gauche
links ecke . canto esquerdo

- *Available in colours Snow, Cream, Beige, Silver, Carbon and Black
- *Disponible dans les couleurs Snow, Cream, Beige, Silver, Carbon et Black
- *Erhältlich in den Farben Snow, Cream, Beige, Silver, Carbon und Black
- *Disponíveis nas cores Snow, Cream, Beige, Silver, Carbon e Black

- **Available in colours Snow, White, Cream, Silver, Grey and Black
- **Disponible dans les couleurs Snow, White, Cream, Silver, Grey et Black
- **Erhältlich in den Farben Snow, White, Cream, Silver, Grey und Black
- **Disponíveis nas cores Snow, White, Cream, Silver, Grey e Black

- ***Available in right and left corner
- ***Disponible dans les coins droit et gauche
- ***Erhältlich in der rechten Ecke und links
- ***Disponível no canto direito e esquerdo

- **** Dimension will vary depending on the base tile thickness.
- **** La dimension varie selon l'épaisseur du carreau.
- **** das Maß variiert je nach Dicke der Fliese.
- **** A dimensão varia consoante a espessura do material cerâmico.

time 2.0

collection

index

colour map

collections

concept

endless

evoke

grove

hybrid

jungle

metropolis

natural

prestige

pure stone

slabstone

stage

subway

tecnica

time 2.0

tool

linea collections

useful information



granito beige 33 30x30 AS

TECHNICAL
FULL BODY
PORCELAIN

tecnica
collection

- 
 DOWNLOAD
CATALOGUE
- 
 DOWNLOAD
TECHNICAL
FEATURES
- 
 VIEW
ONLINE

30x30
N 8,5mm
AS 8,5mm
W 8,5mm
E 12mm

non-rectified product . produit non rectifié . nicht rektifiziert produkt . produto não retificado

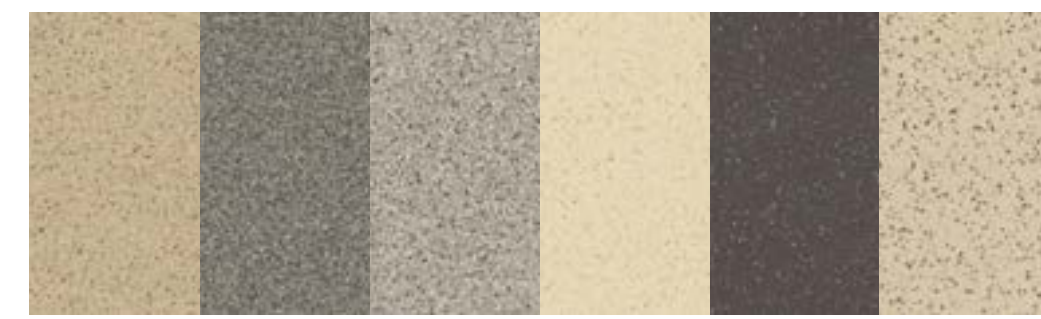

granito beige 33 granito cinza 36 platina 41 branco 44 preto 46 granito preto 75

UGL V0 R11 R10 R9 
AS W N.E



pour plus d'informations, consultez
<https://evaluation.cstb.fr>

MARGRES
CERAMIC TILES

[index](#)

[colour map](#)

collections

- [concept](#)
- [endless](#)
- [evoke](#)
- [grove](#)
- [hybrid](#)
- [jungle](#)
- [metropolis](#)
- [natural](#)
- [prestige](#)
- [pure stone](#)
- [slabstone](#)
- [stage](#)
- [subway](#)
- [tecnica](#)**
- [time 2.0](#)
- [tool](#)

[linea collections](#)

[useful information](#)

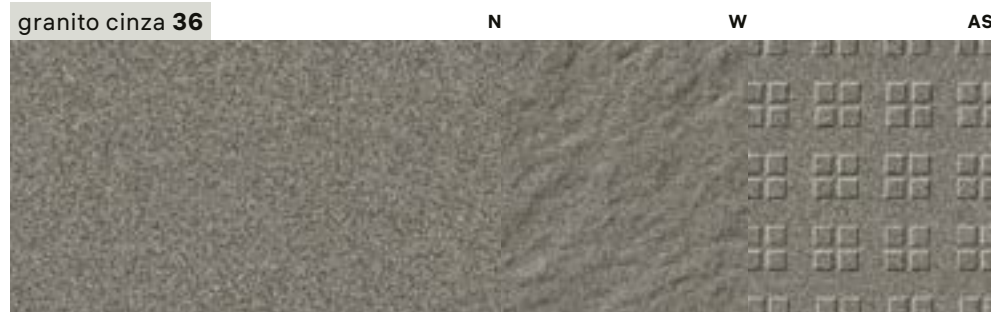
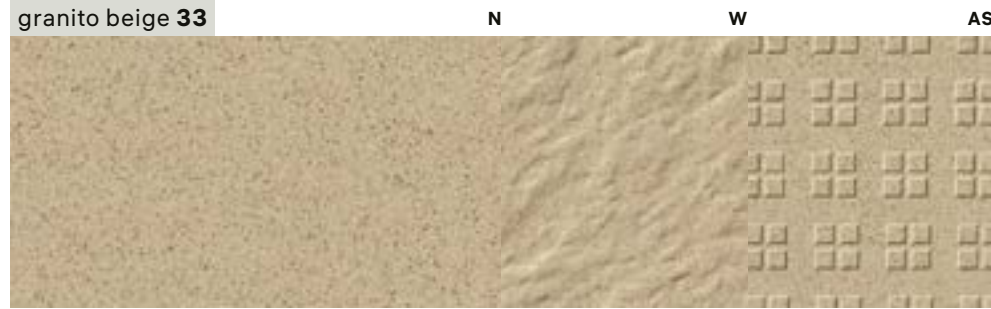

| | | | | |
|-----------------|-------|-----------|-----|---------|
| 30x30 . 12"x12" | 8,5mm | N | R9 | MG-1015 |
| | 8,5mm | W | R10 | MG-1015 |
| | 8,5mm | AS | R11 | MG-1015 |

| | | | | |
|-----------------|-------|-----------|-----|---------|
| 30x30 . 12"x12" | 8,5mm | N | R9 | MG-1015 |
| | 8,5mm | W | R10 | MG-1015 |
| | 8,5mm | AS | R11 | MG-1015 |

| | | | | |
|-----------------|-------|-----------|-----|---------|
| 30x30 . 12"x12" | 8,5mm | N | R9 | MG-1015 |
| | 12mm | E | R9 | MG-1055 |
| | 8,5mm | W | R10 | MG-1015 |
| | 8,5mm | AS | R11 | MG-1015 |

| | | | | |
|-----------------|-------|----------|----|---------|
| 30x30 . 12"x12" | 8,5mm | N | R9 | MG-1040 |
| | 12mm | E | R9 | MG-1080 |

| | | | | |
|-----------------|-------|----------|----|---------|
| 30x30 . 12"x12" | 8,5mm | N | R9 | MG-1040 |
|-----------------|-------|----------|----|---------|

| | | | | |
|-----------------|-------|-----------|-----|---------|
| 30x30 . 12"x12" | 8,5mm | N | R9 | MG-1015 |
| | 12mm | E | R9 | MG-1055 |
| | 8,5mm | W | R10 | MG-1015 |
| | 8,5mm | AS | R11 | MG-1015 |

special finishings

finitions spéciales . speziellen fertigungs . acabamentos especiais

extra thick
forte épaisseur
überstärke fliese
espesurado

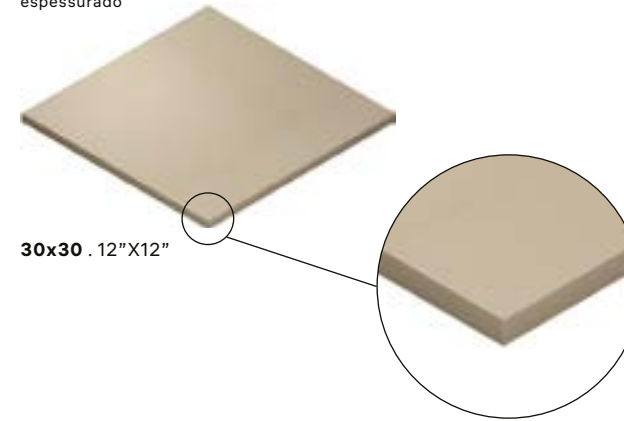

30x30 . 12"x12"

wavy
ondulé
wellig
ondulado

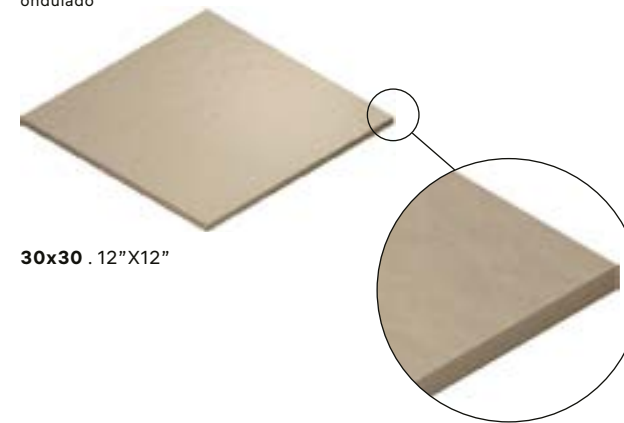

30x30 . 12"x12"

anti-slip
antidérapant
rutschfest
antiderrapante

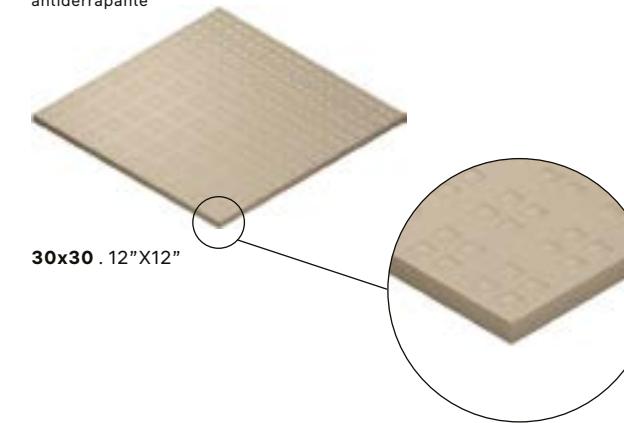

30x30 . 12"x12"

Nor all the presented colours are available in the finishings and indicated formats.
Les couleurs présentées ne sont pas disponibles dans toutes les formats et finitions indiqués.
Die vorhandenen Ausführungen und Formate sind nicht in allen abgebildeten Farben erhältlich.
Nem todas as cores apresentadas estão disponíveis nos acabamentos e formatos indicados.

special pieces

pièces spéciales . spezialteile . peças especiais

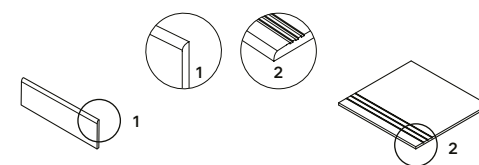

skirting
plinthe
sockel
rodapé boleado
9,5x30 . 3,8"x12"
N MP-6040

step tread grooved
nez de marche creusé
stufenplatte mit rillen
degrau sulcado
30x30 . 12"x12"
N MP-6080



Available in all colours
Disponible dans toutes les couleurs
Erhältlich in allen Farben
Disponível em todas as cores

LINEA

collections . kollektionen . coleções

| | |
|-------------------|--------|
| cosmos | P. 259 |
| endless | P. 227 |
| magnetic | P. 251 |
| prestige | P. 271 |
| pure stone | P. 243 |
| slabstone | P. 279 |
| subway | P. 287 |
| time 2.0 | P. 295 |
| tool | P. 263 |

221

general catalogue . 2024

[index](#)

[colour map](#)

[collections](#)

linea collections

[cosmos](#)

[endless](#)

[magnetic](#)

[prestige](#)

[pure stone](#)

[slabstone](#)

[subway](#)

[time 2.0](#)

[tool](#)

[useful information](#)

MARGRES
CERAMIC TILES

the new surface for avant-garde architecture

LINEA is the new generation of Margres' porcelain tiles which revolutionizes the concept of ceramics, creating new challenges for the use and designing of spaces where other materials were traditionally preferred.

The revolutionary slabs of porcelain tile sheet are produced by means of innovative technology, which combines a pressing force of 15000 tonnes that transforms the purest clays and natural pigments into 3 meters by 1 meter ceramic plates, with 3,5mm, 5,5mm and 6mm thick.

Tiling for swimming pools, ventilated facades, thermal insulation cladding systems and for furniture surfaces. Depending on project specifications and in combination with the construction systems recommended by Margres and approved by the Installation Supervisor.

la nouvelle surface de l'architecture d'avant-garde

LINEA est la nouvelle génération de grès cérame Margres, qui révolutionne le concept de la céramique, en offrant de nouvelles possibilités d'utilisation et de conception des espaces, là où on utilisait auparavant d'autres matériaux.

Des plaques révolutionnaires de grès cérame sont produites en utilisant une technologie innovatrice, qui transforme, par l'application d'une force de pressage de 15 000 tonnes, des argiles très pures et des pigments naturels en plaques de grès cérame de 3 mètres par 1 mètre, avec 3,5mm, 5,5mm et 6mm d'épaisseur à peine.

Revêtement bassins et piscines, façades ventilées, revêtements thermiques à mur-manteau et surfaces à revêtir dans le secteur de la décoration. En fonction des caractéristiques du projet et en combinaison avec les systèmes de construction indiqués par Margres et approuvés par les maîtres d'oeuvre.

die neue oberfläche für avantgarde-architektur

LINEA ist die neue Generation des Feinsteinzeug von Margres, die das klassische Keramikkonzept revolutioniert und innovative Möglichkeiten der Raumausnutzung und -gestaltung eröffnet, bei denen bisher andere Materialien bevorzugt wurden.

Bei der Herstellung der bahnbrechenden dünnen Steinzeugplatten wird eine innovative Technologie angewandt, die reinen Ton und natürliche Pigmente mit 15.000 Tonnen Presskraft in nur 3,5mm, 5,5mm und/oder 6mm Stärke Keramikplatten von bis zu 3 Meter x 1 Meter verwandelt.

Becken und Schwimmbecken, Hinterlüftete Fassaden, Thermische Ummantelungen und Verkleidung von Oberflächen in der Möbelbranchen. In Funktion der Projektangaben und in Kombination mit Konstruktionssystemen, die Margres vorgibt und die Arbeitsleitung genehmigt.

a nova superfície para a arquitetura de vanguarda

LINEA é a nova geração de grés porcelânico Margres que revoluciona o próprio conceito da cerâmica, abrindo novas oportunidades de utilização e conceção do espaço, onde antes eram preferidos outros materiais.

As revolucionárias placas grés lâmina, são produzidas com recurso a uma tecnologia inovadora, que transforma por meio de uma força de prensagem de 15.000 toneladas, argilas puríssimas e pigmentos naturais em placas cerâmicas de 3 metros por 1 metro com 3,5mm, 5,5mm e 6mm de espessura.

Revestimentos de banhos e piscinas, fachadas ventiladas, sistemas de revestimento de isolamento térmico e superfícies de revestimento no sector de decoração. Dependendo das características do projeto e em combinação com sistemas de construção indicadas pela Margres e aprovados pelo supervisor de obra.

advantages

avantagens . vorteile . vantagens

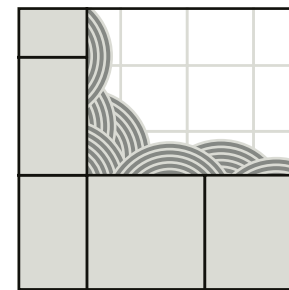

easy to install
facile à poser
einfach aufzutragen
fácil de aplicar

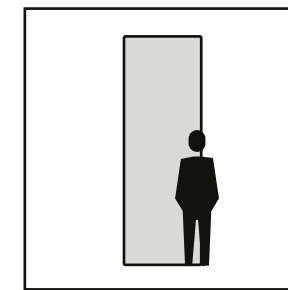

big
grand
groß
grande

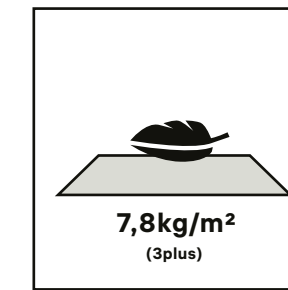

thin and light
fin et léger
dünn und leicht
fino e leve

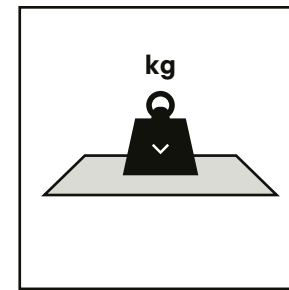

resistent
résistant
beständig
resistente

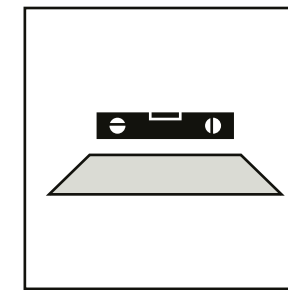

flat
lisse
flach
plano

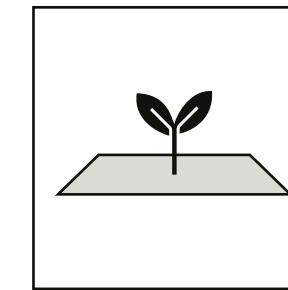

ecofriendly
écologique
ökologisch
ecológico



We reduce the distance between us and zero impact, reducing everything in between. Please see page 306.

Nous réduisons la distance qui nous sépare de l'impact zéro, en réduisant tout ce qui se trouve entre les deux. Veuillez s'il vous plaît consulter la page 306.

Wir verringern den Abstand zwischen uns und der Nullbelastung und reduzieren alles, was dazwischen liegt. Bitte sehen Sie Seite 306.

Diminuímos a distância entre nós e o impacto zero, reduzindo tudo o que está no meio. Por favor, consultar a página 306.

PROTECT

Antibacterial for Life.

An exclusive line of extremely high performance antimicrobial floor and wall tiles, designed for healthy, safe and protected living spaces. Please see page 304.

Une ligne exclusive de sols et revêtements antibactériens aux performances très élevées, pour un habitat sain, sûr et protégé. Veuillez s'il vous plaît consulter la page 304.

Eine exklusive Linie an hochwertigen Fußböden und antibakteriellen Wandverkleidungen, für ein gesundes, sicheres und geschütztes Leben. Bitte sehen Sie Seite 304.

Uma linha exclusiva de pavimentos e revestimentos antimicrobianos de altíssima performance, projetada para ambientes saudáveis, seguros e protegidos. Por favor, consultar a página 304.

linea collections

cosmos

endless

magnetic

prestige

pure stone

slabstone

subway

time 2.0

tool

useful information



intended uses

domaines d'emploi . verwendungszwecke . utilizações previstas

wall installation



pose au mur
wandverlegung
aplicação em revestimento

For **new buildings** and **refurbishing** with installation on existing walls.

Application dans des **nouvelles constructions** ou des **restructurations** avec pose sur des murs préexistants.

Anwendungen sowohl in **neubauten** wie auch **renovierungen** mit Verlegung auf vorhandenen Wände.

Aplicação em **novas construções** ou intervenções em **obras de restauro**, com sobreposição do material em revestimentos preexistentes.

| | LINEA 3plus | LINEA 5plus | LINEA 6mm |
|--|----------------|----------------|--------------|
|  interiors intérieur innenbereiche interiores <p>Any residential and commercial. Toute zone résidentielle et commerciale. Fuer jede Wohn- und Handelsbereich. Qualquer área residencial e comercial.</p> | ■ | ■ | ■ |
|  exteriors extérieur ausenbereiche exteriores <p>On concrete or plaster supports, where corner cuts and large sizes are necessary not larger than 120x120 cm. Sur chape en béton ou enduit où il est nécessaire d'exécuter des découpes angulaires et d'utiliser de grands formats non supérieurs à 120x120 cm. Auf Untergründen aus Beton oder Putz, auf denen Eckschnitte gefertigt und Großformate verwendet werden müssen, nicht größer als 120x120 cm. Em bases de cimento ou reboco, onde é necessária a realização de cortes angulares e/ou aplicar formatos de grandes dimensões não superiores a 120x120cm.</p> | ■ | ■ | ■ |

special uses

utilisations spéciales . spezielle verwendungszwecke . aplicações especiais

Tiling for swimming pools, ventilated facades, thermal insulation cladding systems and for furniture surfaces.

Depending on project specifications and in combination with the construction systems recommended by Margres and approved by the Installation Supervisor.

Revêtement bassins et piscines, façades ventilées, revêtements thermiques à mur-manteau et surfaces à revêtir dans le secteur de la décoration.

En fonction des caractéristiques du projet et en combinaison avec les systèmes de construction indiqués par Margres et approuvés par les maîtres d'oeuvre.

Becken und Schwimmbecken, Hinterlüftete Fassaden, Thermische Ummantelungen und Verkleidung von Oberflächen in der Möbelbranchen.

In Funktion der Projektangaben und in Kombination mit Konstruktionssystemen, die Margres vorgibt und die Arbeitsleitung genehmigt.

Revestimentos de banhos e piscinas, fachadas ventiladas, sistemas de revestimento de isolamento térmico e superfícies de revestimento no sector de decoração.

Dependendo das características do projeto e em combinação com sistemas de construção indicadas pela Margres e aprovados pelo supervisor de obra.

intended uses

domaines d'emploi . verwendungszwecke . utilizações previstas

floor installation



pose au sol
bodenverlegung
aplicação em pavimento

For **new buildings** and **refurbishing** with installation on existing floors.

Application dans des **nouvelles constructions** ou des **restructurations** avec pose sur des sols préexistants.

Für **neubauten** und **renovierungen** mit Verlegung auf vorhandenen Böden.

Aplicação em **novas construções** ou intervenções em **obras de restauro**, com sobreposição do material em pavimentos preexistentes.

| | LINEA 3plus | LINEA 5plus | LINEA 6mm |
|---|----------------|---|--------------|
|  interiors intérieur innenbereiche interiores <p>Residential (kitchens, bathrooms, living rooms, common apartment block areas and any other residential environment) with the exception of areas subject to heavy loads (e.g. trolleys with hard wheels). Résidentiel (cuisines, salles de bains, salles de séjour, zones de copropriété collectives, et tout autre espace à usage résidentiel). Sauf les zones soumises au passage de charges lourdes concentrées (ex.: chariots à roues dures). Wohnbereiche (Küchen, Badezimmer, Wohnzimmer, Gemeinschaftsflächen in Mehrfamilienhäusern und alle sonstigen Wohnbereiche). Ausgenommen Bereiche mit Durchfahrtsverkehr von konzentrierten Schwerlasten (z.B. Wagen mit Hartgummirädern). Utilização residencial (cozinhas, casas de banho, salas de estar, áreas comuns de condomínios e em qualquer outro ambiente de uso residencial), excluindo zonas sujeitas a passagem de cargas pesadas concentradas (por exemplo, carrinhos com rodas rígidas).</p> | ■ | ■ | ■ |
|  interiors intérieur innenbereiche interiores <p>Light commercial (offices, offices open to the general public, waiting rooms, shops, bathrooms, restaurant dining rooms, car showrooms, bars, cinemas, surgeries/clinics) with the exception of areas subject to heavy loads (e.g. trolleys with hard wheels). Traffic moderé (bureaux, bureaux ouverts au public, salles d'attente, magasins, salles de bains, salles de restaurants, salons automobiles, bars, cinémas, dispensaires/cliniques). Sauf les zones soumises au passage de charges lourdes concentrées (ex.: chariots à roues dures). Leichte gewerbliche anwendungen (Büroräume, öffentliche Büros, Wartezimmer, Geschäfte, Toiletten, Gaststätten, Autohäuser, Cafés, Kinos, Praxen/Kliniken). Ausgenommen Bereiche mit Durchfahrtsverkehr von konzentrierten Schwerlasten (z.B. Wagen mit Hartgummirädern). Utilização comercial ligeira (escritórios, escritórios abertos ao público, salas de espera, lojas, casas de banho, salas de restaurantes, stands de automóveis, bares, cinemas, centros de saúde/clinicas), excluindo zonas sujeitas a passagem de cargas pesadas concentradas (por exemplo, carrinhos com rodas rígidas).</p> | ■ | ■ except polished sauf poli Außer poliert exceto polido | ■ |
|  interiors intérieur innenbereiche interiores <p>Heavy duty commercial (public areas of shopping centres, hotel halls, canteens, fast food restaurants, clubs, hospitals) with the exception of areas subject to heavy loads (e.g. trolleys with hard wheels). Commercial intensif (zones communes de centres commerciaux, halls d'hôtels, cantines, fast-foods, discothèques, hôpitaux). Sauf les zones soumises au passage de charges lourdes concentrées (ex.: chariots à roues dures). Intensive gewerbliche anwendungen (Gemeinschaftsbereiche in Einkaufszentren, Hotelhallen, Kantinen, Fastfood-Restaurants, Diskotheken, Krankenhäuser). Ausgenommen Bereiche mit Durchfahrtsverkehr von konzentrierten Schwerlasten (z.B. Wagen mit Hartgummirädern). Utilização comercial intensiva (áreas comuns de centros comerciais, lobbies de hotéis, cantinas, restaurantes de fastfood, discotecas, hospitais), excluindo zonas sujeitas a passagem de cargas pesadas concentradas (por exemplo, carrinhos com rodas rígidas).</p> | | ■ except polished sauf poli Außer poliert exceto polido | ■ |

Installation must be performed in compliance with the standards published on the Margres Technical Manual.

La pose doit être effectuée selon les normes publiées dans le Manuel Technique Margres.

Die Verlegung muss nach den Vorschriften im Technischen Handbuch von Margres erfolgen.

A aplicação deve ser realizada em conformidade com as normas publicadas no Manual Técnico Margres.



226

general catalogue . 2024

calacatta gold LED1 100x300 SM . 100x100 SM . port black LED4 P

LAMINATED
PORCELAIN
STONEWARE

linea endless

collection —
P. 57

- 
 DOWNLOAD
CATALOGUE
- 
 DOWNLOAD
TECHNICAL
FEATURES
- 
 VIEW
ONLINE

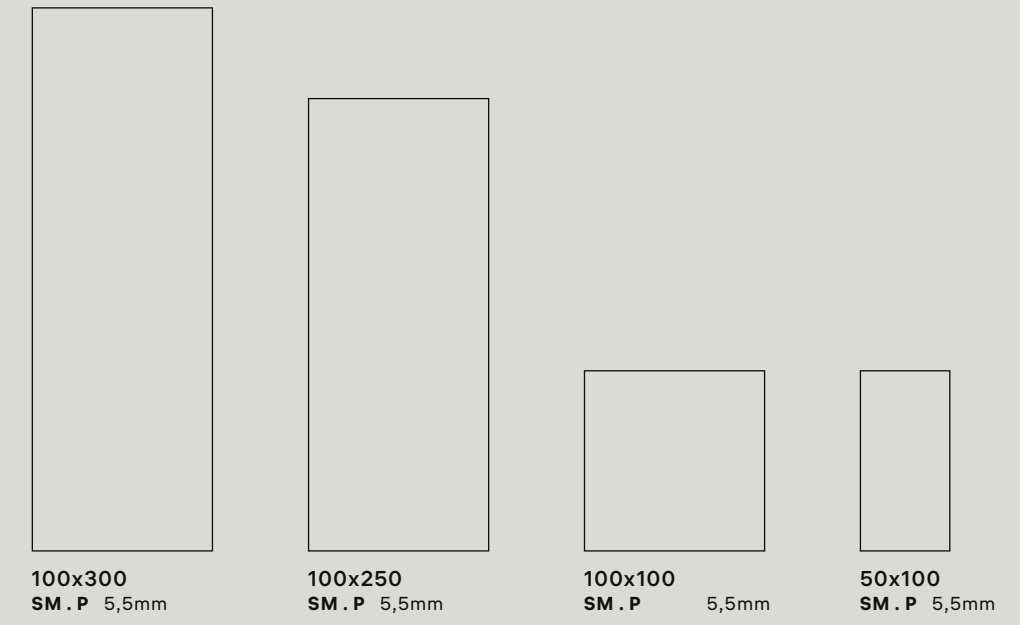

rectified products . produits rectifiés . rektifizierete produkte . produtos retificados



calacatta gold LED1 breccia capraia LED2 travertino LED3 port black LED4 amazonite LED5



PR()TECT®
Antibacterial for Life.

227

general catalogue . 2024

index —

colour map —

collections —

linea collections

cosmos

endless

magnetic

prestige

pure stone

slabstone

subway

time 2.0

tool

useful information —

linea endless
collection

linea endless
collection

index

colour map

collections

linea collections

cosmos

endless

magnetic

prestige

pure stone

slabstone

subway

time 2.0

tool

useful information

228

general catalogue . 2024

229

general catalogue . 2024

calacatta gold LED1 100x300 P . 100x100 P



230

general catalogue . 2024



231

general catalogue . 2024

breccia capraia LED2 100x300 SM . 100x100 SM

index

colour map

collections

linea collections

cosmos

endless

magnetic

prestige

pure stone

slabstone

subway

time 2.0

tool

useful information

linea endless

collection

linea endless

collection

index

colour map

collections

linea collections

cosmos

endless

magnetic

prestige

pure stone

slabstone

subway

time 2.0

tool

useful information

232

general catalogue . 2024

233

general catalogue . 2024

chain breccia capraia LED2 100x300 P . slabstone grey LSL5 100x100 NR



234

general catalogue . 2024



235

general catalogue . 2024

travertino LED3 100x300 SM . 100x100 SM

index

colour map

collections

linea collections

cosmos

endless

magnetic

prestige

pure stone

slabstone

subway

time 2.0

tool

useful information



236

general catalogue . 2024

237

general catalogue . 2024

linea endless

collection

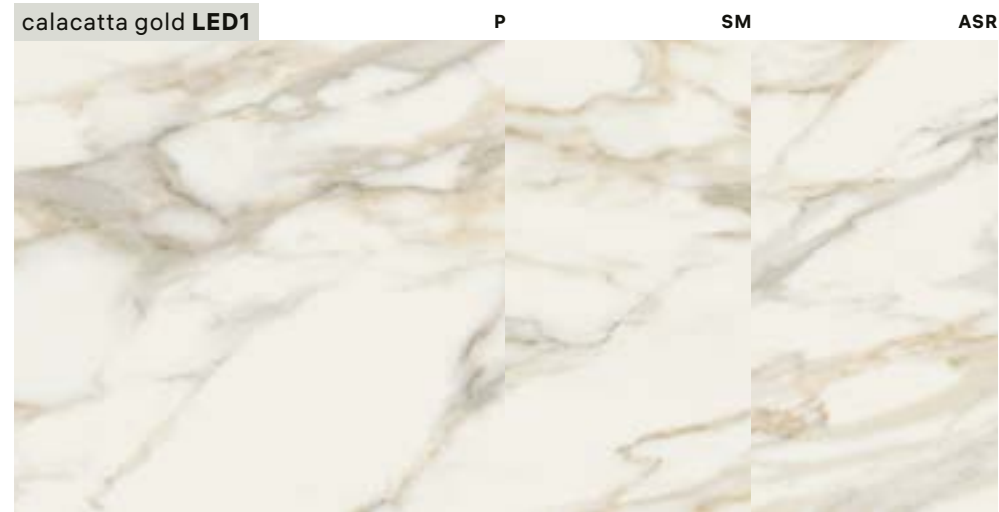

LINEA

| | | | | |
|-----------------------|-------|----|---|---------|
| 50x100 . 19,6"x39,4" | 5,5mm | SM | - | M3-1930 |
| | 5,5mm | P | - | M3-2330 |
| 100x100 . 39,4"x39,4" | 5,5mm | SM | - | M3-2730 |
| | 5,5mm | P | - | M3-3130 |
| 100x250 . 39,4"x98,4" | 5,5mm | SM | - | M3-3530 |
| | 5,5mm | P | - | M3-3830 |
| 100x300 . 39,4"x118" | 5,5mm | SM | - | M3-4230 |
| | 5,5mm | P | - | M3-4630 |



LINEA

| | | | | |
|-----------------------|-------|----|---|---------|
| 50x100 . 19,6"x39,4" | 5,5mm | SM | - | M3-1930 |
| | 5,5mm | P | - | M3-2330 |
| 100x100 . 39,4"x39,4" | 5,5mm | SM | - | M3-2730 |
| | 5,5mm | P | - | M3-3130 |
| 100x250 . 39,4"x98,4" | 5,5mm | SM | - | M3-3530 |
| | 5,5mm | P | - | M3-3830 |
| 100x300 . 39,4"x118" | 5,5mm | SM | - | M3-4230 |
| | 5,5mm | P | - | M3-4630 |

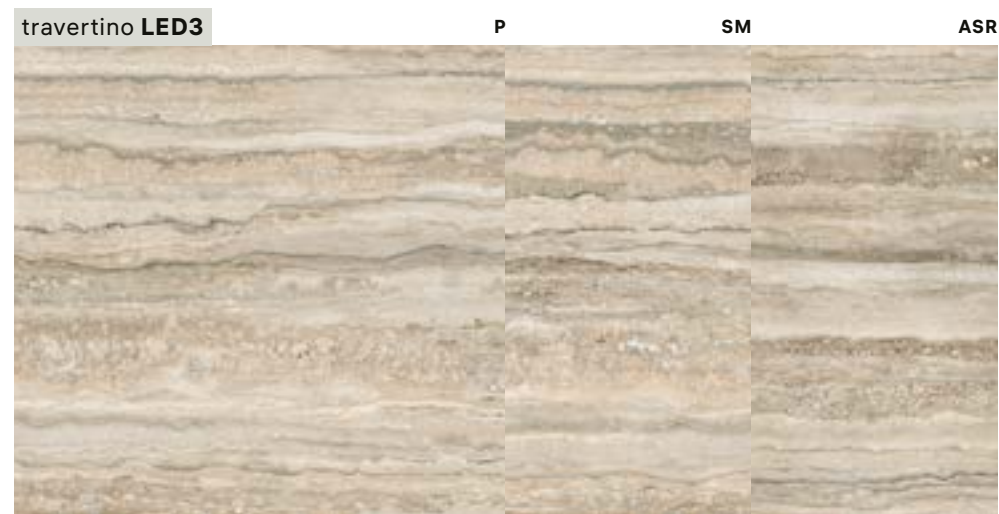

LINEA

| | | | | |
|-----------------------|-------|----|---|---------|
| 50x100 . 19,6"x39,4" | 5,5mm | SM | - | M3-1930 |
| | 5,5mm | P | - | M3-2330 |
| 100x100 . 39,4"x39,4" | 5,5mm | SM | - | M3-2730 |
| | 5,5mm | P | - | M3-3130 |
| 100x250 . 39,4"x98,4" | 5,5mm | SM | - | M3-3530 |
| | 5,5mm | P | - | M3-3830 |
| 100x300 . 39,4"x118" | 5,5mm | SM | - | M3-4230 |
| | 5,5mm | P | - | M3-4630 |

linea endless

collection

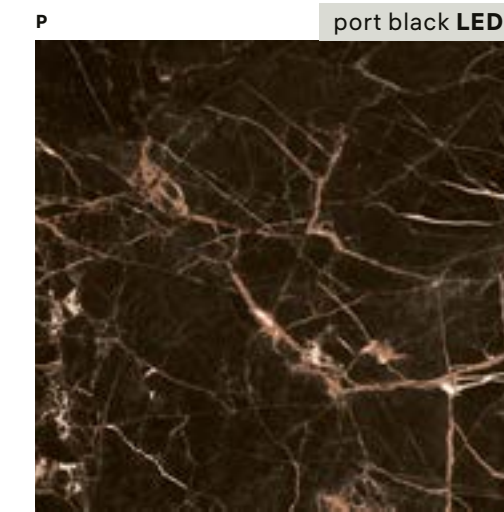

LINEA

| | | | | |
|-----------------------|-------|---|---|---------|
| 50x100 . 19,6"x39,4" | 5,5mm | P | - | M3-2330 |
| | 5,5mm | P | - | M3-3130 |
| 100x250 . 39,4"x98,4" | 5,5mm | P | - | M3-3830 |
| | 5,5mm | P | - | M3-4630 |

LINEA

| | | | | |
|-----------------------|-------|---|---|---------|
| 50x100 . 19,6"x39,4" | 5,5mm | P | - | M3-2330 |
| | 5,5mm | P | - | M3-3130 |
| 100x250 . 39,4"x98,4" | 5,5mm | P | - | M3-3830 |
| | 5,5mm | P | - | M3-4630 |

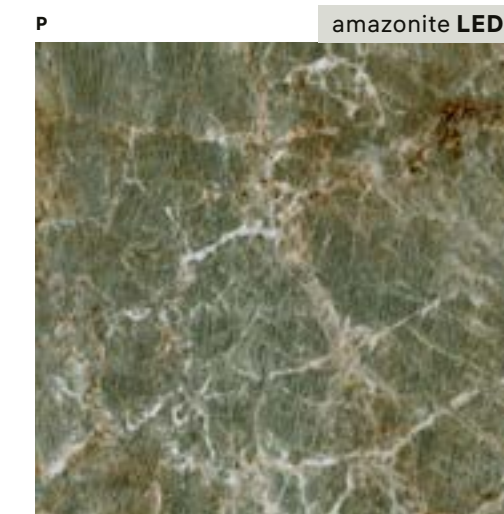

amazonite LED5

LINEA

| | | | | |
|-----------------------|-------|----|---|---------|
| 50x100 . 19,6"x39,4" | 5,5mm | SM | - | M3-1930 |
| | 5,5mm | P | - | M3-2330 |
| 100x100 . 39,4"x39,4" | 5,5mm | SM | - | M3-2730 |
| | 5,5mm | P | - | M3-3130 |
| 100x250 . 39,4"x98,4" | 5,5mm | SM | - | M3-3530 |
| | 5,5mm | P | - | M3-3830 |
| 100x300 . 39,4"x118" | 5,5mm | SM | - | M3-4230 |
| | 5,5mm | P | - | M3-4630 |

Products with a polished finish are more sensitive to abrasion and stains, what requires special conditions. Please see page 328 in chapter 09.
 Les produits à finition polie sont plus sensibles à l'abrasion et aux taches, ce qui requiert des conditions particulières. Veuillez-vous consulter la page 328 du chapitre 09.
 Produkte mit einer polierten Oberfläche sind empfindlicher gegen Abrieb und Fleckenbildung, was besondere Bedingungen erfordert. Bitte beachten Sie Seite 328 in Kapitel 09.
 Os produtos com acabamento polido são mais sensíveis à abrasão e às manchas, o que requer condições especiais. Por favor consulte a página 328 no capítulo 09.

linea endless

collection

chain breccia capraia LED2



A B C D E

LINEA

100x300 . 39,4"x118" 5,5mm P - M3-4930

chain amazonite LED5

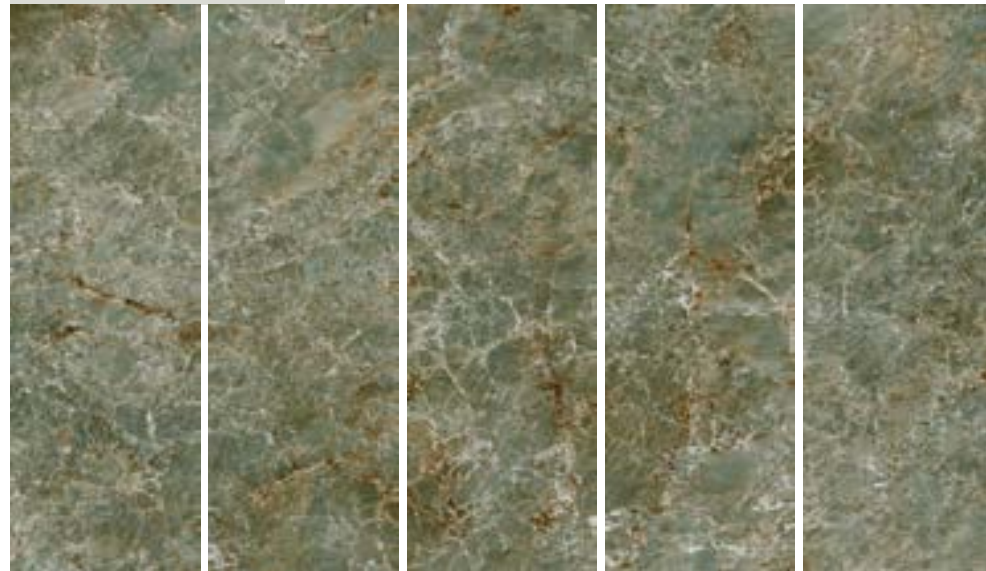

A B C D E

LINEA

100x300 . 39,4"x118" 5,5mm P - M3-4930

linea endless

collection



index

colour map

collections

linea collections

cosmos

endless

magnetic

prestige

pure stone

slabstone

subway

time 2.0

tool

useful information

240

general catalogue . 2024

241

general catalogue . 2024

Can only be purchased as complete composition.

Cette composition ne peut être vendue séparément, mais en un ensemble unique.

Nur in voller Zusammensetzung erhältlich.

Só pode ser adquirido como conjunto completo.

The picture is purely illustrative. The graphic design of **chain** may result in discontinuities in the veining between panels, as with the natural material. Discontinuities of up to 1,5 cm are not defects, but are characteristic of the product.

L'image n'est donnée qu'à titre indicatif. Le graphisme de **chain** peut présenter une discontinuité du veinage dans le passage entre les dalles, tout comme le matériau naturel. Toute différence jusqu'à 1,5 cm doit donc être considérée comme une caractéristique du produit.

Die Abbildung ist rein illustrativ. Die Grafik **chain** kann wie beim natürlichen Material Maserungs-Diskontinuitäten beim Übergang zwischen den Platten aufweisen. Eventuelle Unterschiede bis zu 1,5 cm gelten daher als produkttypisch.

A imagem é puramente indicativa. O desenho gráfico do **chain** pode mostrar uma descontinuidade do veio na transição entre painéis cerâmicos, tal como no material natural. Quaisquer diferenças até 1,5 cm devem ser consideradas como uma característica do produto.

MARGRES
CERAMIC TILES

amazonite LED5 100x300 P . 100x100 P



beige LPS2 100x300 NR . grey LPS4 100x300 NR . 100x100 NR

LAMINATED
PORCELAIN
STONEWARE

linea pure stone

collection **—**
P. 69

 **DOWNLOAD CATALOGUE**

 **DOWNLOAD TECHNICAL FEATURES**

 **VIEW ONLINE**

 **DOWNLOAD BIM**



100x300
NR 6mm



100x250
NR 6mm



100x100
NR 6mm



50x100
NR 6mm

rectified products . produits rectifiés . rektifizierete produkte . produtos retificados



white
LPS1

beige
LPS2

light grey
LPS3

grey
LPS4

forge white
LPS1F

forge light grey
LPS3F

UGL **V2** **R10** **R9** 
FORGE NR

PR()TECT®

Antibacterial for Life.

MARGRES
CERAMIC TILES

index

colour map

collections

linea collections

cosmos

endless

magnetic

prestige

pure stone

slabstone

subway

time 2.0

tool

useful information

linea pure stone
collection

linea pure stone
collection

index

colour map

collections

linea collections

cosmos

endless

magnetic

prestige

pure stone

slabstone

subway

time 2.0

tool

useful information

244

general catalogue . 2024

245

general catalogue . 2024

white LPS1 100x300 NR . 100x100 NR

linea pure stone
collection



246

general catalogue . 2024

MARGRES
CERAMIC TILES

linea pure stone
collection



247

general catalogue . 2024

light grey LPS3 100x300 NR . 100x100 NR

index

colour map

collections

linea collections

cosmos

endless

magnetic

prestige

pure stone

slabstone

subway

time 2.0

tool

useful information

linea pure stone

collection

white LPS1



NR

LINEA

| | | | | |
|-----------------------|-----|----|----|---------|
| 50x100 . 19,6"x39,4" | 6mm | NR | R9 | M3-5230 |
| 100x100 . 39,4"x39,4" | 6mm | NR | R9 | M3-6230 |
| 100x250 . 39,4"x98,4" | 6mm | NR | R9 | M3-7300 |
| 100x300 . 39,4"x118" | 6mm | NR | R9 | M3-7730 |

beige LPS2



NR

LINEA

| | | | | |
|-----------------------|-----|----|----|---------|
| 50x100 . 19,6"x39,4" | 6mm | NR | R9 | M3-5230 |
| 100x100 . 39,4"x39,4" | 6mm | NR | R9 | M3-6230 |
| 100x250 . 39,4"x98,4" | 6mm | NR | R9 | M3-7300 |
| 100x300 . 39,4"x118" | 6mm | NR | R9 | M3-7730 |

light grey LPS3



NR

LINEA

| | | | | |
|-----------------------|-----|----|----|---------|
| 50x100 . 19,6"x39,4" | 6mm | NR | R9 | M3-5230 |
| 100x100 . 39,4"x39,4" | 6mm | NR | R9 | M3-6230 |
| 100x250 . 39,4"x98,4" | 6mm | NR | R9 | M3-7300 |
| 100x300 . 39,4"x118" | 6mm | NR | R9 | M3-7730 |

linea pure stone

collection

grey LPS4

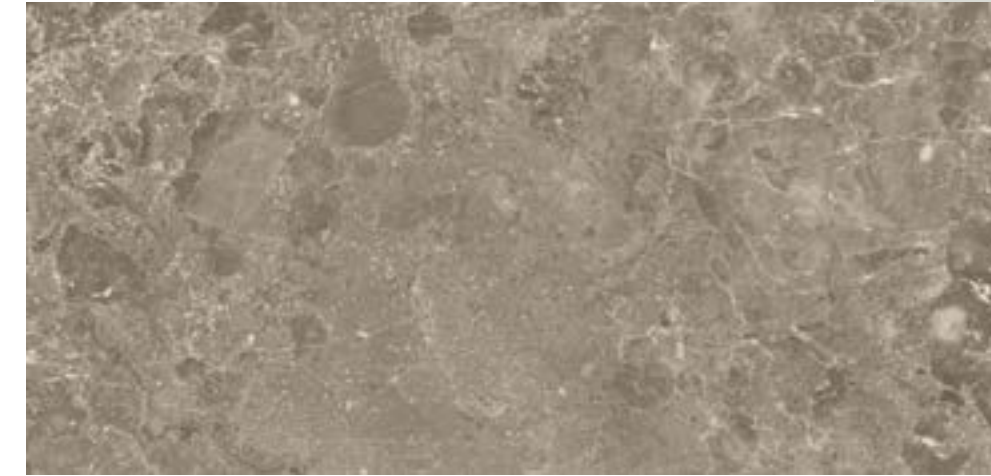

NR

LINEA

| | | | | |
|-----------------------|-----|----|----|---------|
| 50x100 . 19,6"x39,4" | 6mm | NR | R9 | M3-5230 |
| 100x100 . 39,4"x39,4" | 6mm | NR | R9 | M3-6230 |
| 100x250 . 39,4"x98,4" | 6mm | NR | R9 | M3-7300 |
| 100x300 . 39,4"x118" | 6mm | NR | R9 | M3-7730 |

NR

forge white LPS1F



LINEA

| | | | | |
|-----------------------|-----|----|-----|---------|
| 50x100 . 19,6"x39,4" | 6mm | NR | R10 | M3-5230 |
| 100x100 . 39,4"x39,4" | 6mm | NR | R10 | M3-6230 |
| 100x250 . 39,4"x98,4" | 6mm | NR | R10 | M3-7300 |
| 100x300 . 39,4"x118" | 6mm | NR | R10 | M3-7730 |

NR

forge light grey LPS3F



LINEA

| | | | | |
|-----------------------|-----|----|-----|---------|
| 50x100 . 19,6"x39,4" | 6mm | NR | R10 | M3-5230 |
| 100x100 . 39,4"x39,4" | 6mm | NR | R10 | M3-6230 |
| 100x250 . 39,4"x98,4" | 6mm | NR | R10 | M3-7300 |
| 100x300 . 39,4"x118" | 6mm | NR | R10 | M3-7730 |

index

colour map

collections

linea collections

cosmos

endless

magnetic

prestige

pure stone

slabstone

subway

time 2.0

tool

useful information



250

general catalogue . 2024

cement anthracite LMC2 100x100 NR

LAMINATED
PORCELAIN
STONEWARE

linea magnetic

collection

↓
DOWNLOAD
CATALOGUE

↓
DOWNLOAD
TECHNICAL
FEATURES

🌐
VIEW
ONLINE



100x300
NR 6mm

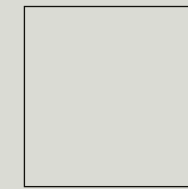

100x100
NR 6mm

rectified products . produits rectifiés . rektifizierte produkte . produtos retificados

251

general catalogue . 2024



cement grey
LMC1

cement anthracite
LMC2

stone grey
LMS3

stone anthracite
LMS4

UGL **V2** **R10** **R9**

LMS LMC

PR()TECT®

Antibacterial for Life.

MARGRES
CERAMIC TILES

index

colour map

collections

linea collections

cosmos

endless

magnetic

prestige

pure stone

slabstone

subway

time 2.0

tool

useful information



252

general catalogue . 2024



253

general catalogue . 2024

index

colour map

collections

linea collections

cosmos

endless

magnetic

prestige

pure stone

slabstone

subway

time 2.0

tool

useful information



254

general catalogue . 2024



255

general catalogue . 2024

cement grey LMC1 100x300 NR . 100x100 NR

index

colour map

collections

linea collections

cosmos

endless

magnetic

prestige

pure stone

slabstone

subway

time 2.0

tool

useful information

linea magnetic
collection

cement grey **LMC1** NR



| LINEA | | | | | |
|-----------------------|-----|----|----|---------|--|
| 100x100 . 39,4"x39,4" | 6mm | NR | R9 | M3-6230 | |
| 100x300 . 39,4"x118" | 6mm | NR | R9 | M3-7730 | |

cement anthracite **LMC2** NR



| LINEA | | | | | |
|-----------------------|-----|----|----|---------|--|
| 100x100 . 39,4"x39,4" | 6mm | NR | R9 | M3-6230 | |
| 100x300 . 39,4"x118" | 6mm | NR | R9 | M3-7730 | |

linea magnetic
collection

stone grey **LMS3** NR



| LINEA | | | | | |
|-----------------------|-----|----|-----|---------|--|
| 100x100 . 39,4"x39,4" | 6mm | NR | R10 | M3-6230 | |
| 100x300 . 39,4"x118" | 6mm | NR | R10 | M3-7730 | |

stone anthracite **LMS4** NR



| LINEA | | | | | |
|-----------------------|-----|----|-----|---------|--|
| 100x100 . 39,4"x39,4" | 6mm | NR | R10 | M3-6230 | |
| 100x300 . 39,4"x118" | 6mm | NR | R10 | M3-7730 | |

index

colour map

collections

linea collections

cosmos

endless

magnetic

prestige

pure stone

slabstone

subway

time 2.0

tool

useful information



258

general catalogue . 2024

iron LCM2 100x300 NR . 100x100 NR

LAMINATED
PORCELAIN
STONEWARE

linea cosmos

collection —

- ↓
DOWNLOAD
CATALOGUE
- ↓
DOWNLOAD
TECHNICAL
FEATURES
- 🌐
VIEW
ONLINE

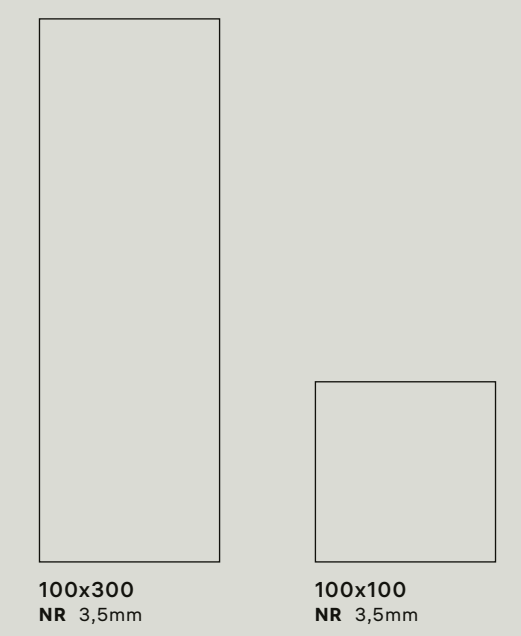

rectified products . produits rectifiés . rektifizierete produkte . produtos retificados

259

general catalogue . 2024



corten
LCM1

iron
LCM2

UGL V2 R10 NR

PROTECT
Antibacterial for Life.

MARGRES
CERAMIC TILES

index —

colour map —

collections —

linea collections —

cosmos

endless

magnetic

prestige

pure stone

slabstone

subway

time 2.0

tool

useful information —

linea cosmos
collection



260

general catalogue . 2024

corten LCM1 100x300 NR . 100x100 NR

linea cosmos
collection

LINBA

| | | | | |
|-----------------------|-------|----|-----|---------|
| 100x100 . 39,4"x39,4" | 3,5mm | NR | R10 | M3-1230 |
| 100x300 . 39,4"x118" | 3,5mm | NR | R10 | M3-1530 |

LINBA

| | | | | |
|-----------------------|-------|----|-----|---------|
| 100x100 . 39,4"x39,4" | 3,5mm | NR | R10 | M3-1230 |
| 100x300 . 39,4"x118" | 3,5mm | NR | R10 | M3-1530 |

NR

corten LCM1



NR

iron LCM2



261

general catalogue . 2024

index

colour map

collections

linea collections

cosmos

endless

magnetic

prestige

pure stone

slabstone

subway

time 2.0

tool

useful information

PROTECT

Antibacterial for Life.



262



general catalogue . 2024

tortora LTL3 120x260 NR . 120x120 NR

LAMINATED
PORCELAIN
STONEWARE

linea tool

collection —
P. 163

- 
 DOWNLOAD
CATALOGUE
- 
 DOWNLOAD
TECHNICAL
FEATURES
- 
 VIEW
ONLINE



120x260
NR 6mm

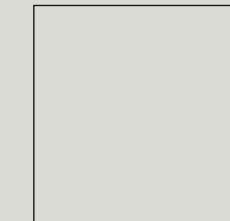

120x120
NR 6mm



60x120
NR 6mm

rectified products . produits rectifiés . rektifizierete produkte . produtos retificados



white
LTL1

light grey
LTL2

tortora
LTL3

grey
LTL4

UGL **V3** **R9** 
NR

PR()TECT®
Antibacterial for Life.

MARGRES
CERAMIC TILES

263

general catalogue . 2024

index

colour map

collections

linea collections

cosmos

endless

magnetic

prestige

pure stone

slabstone

subway

time 2.0

tool

useful information



linea tool
collection

linea tool
collection

264

general catalogue . 2024

265

general catalogue . 2024

grey LTL4 120x120 NR

index

colour map

collections

linea collections

cosmos

endless

magnetic

prestige

pure stone

slabstone

subway

time 2.0

tool

useful information



266

general catalogue . 2024



267

general catalogue . 2024

light grey LTL2 120x260 NR . 120x120 NR . white LTL1 NR

index

colour map

collections

linea collections

cosmos

endless

magnetic

prestige

pure stone

slabstone

subway

time 2.0

tool

useful information

linea tool
collection



white LTL1

NR

| LINEA | | | | | |
|--------------------|-----|----|----|---------|--|
| 60x120 . 24"x48" | 6mm | NR | R9 | M3-5730 | |
| 120x120 . 48"x48" | 6mm | NR | R9 | M3-6730 | |
| 120x260 . 48"x102" | 6mm | NR | R9 | M3-8230 | |

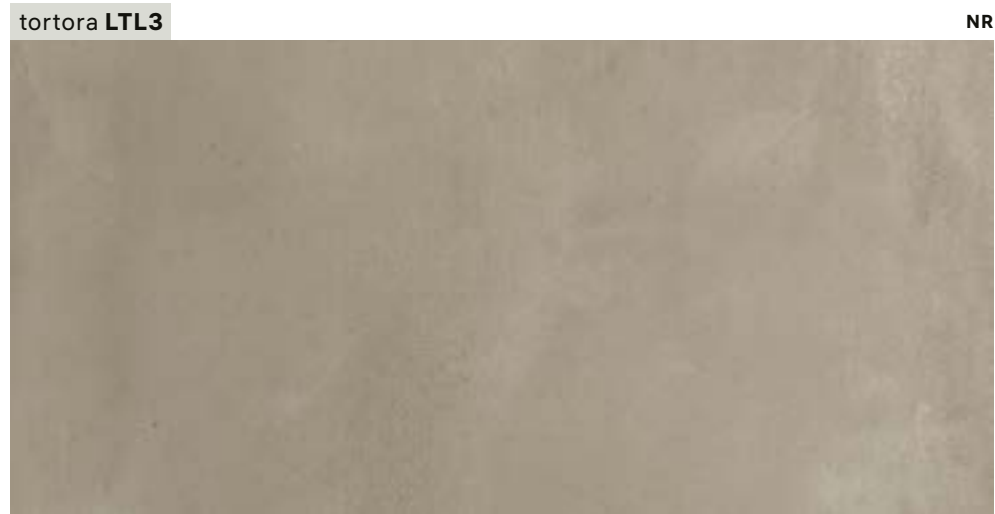

tortora LTL3

NR

| LINEA | | | | | |
|--------------------|-----|----|----|---------|--|
| 60x120 . 24"x48" | 6mm | NR | R9 | M3-5730 | |
| 120x120 . 48"x48" | 6mm | NR | R9 | M3-6730 | |
| 120x260 . 48"x102" | 6mm | NR | R9 | M3-8230 | |

| LINEA | | | | | |
|--------------------|-----|----|----|---------|--|
| 60x120 . 24"x48" | 6mm | NR | R9 | M3-5730 | |
| 120x120 . 48"x48" | 6mm | NR | R9 | M3-6730 | |
| 120x260 . 48"x102" | 6mm | NR | R9 | M3-8230 | |



NR

light grey LTL2



NR

grey LTL4

| LINEA | | | | | |
|--------------------|-----|----|----|---------|--|
| 60x120 . 24"x48" | 6mm | NR | R9 | M3-5730 | |
| 120x120 . 48"x48" | 6mm | NR | R9 | M3-6730 | |
| 120x260 . 48"x102" | 6mm | NR | R9 | M3-8230 | |



270

general catalogue . 2024

calacatta LPT1 100x300 P . 100x100 P

LAMINATED
PORCELAIN
STONEWARE

linea prestige

collection —
P. 127

- 
 DOWNLOAD
CATALOGUE
- 
 DOWNLOAD
TECHNICAL
FEATURES
- 
 VIEW
ONLINE

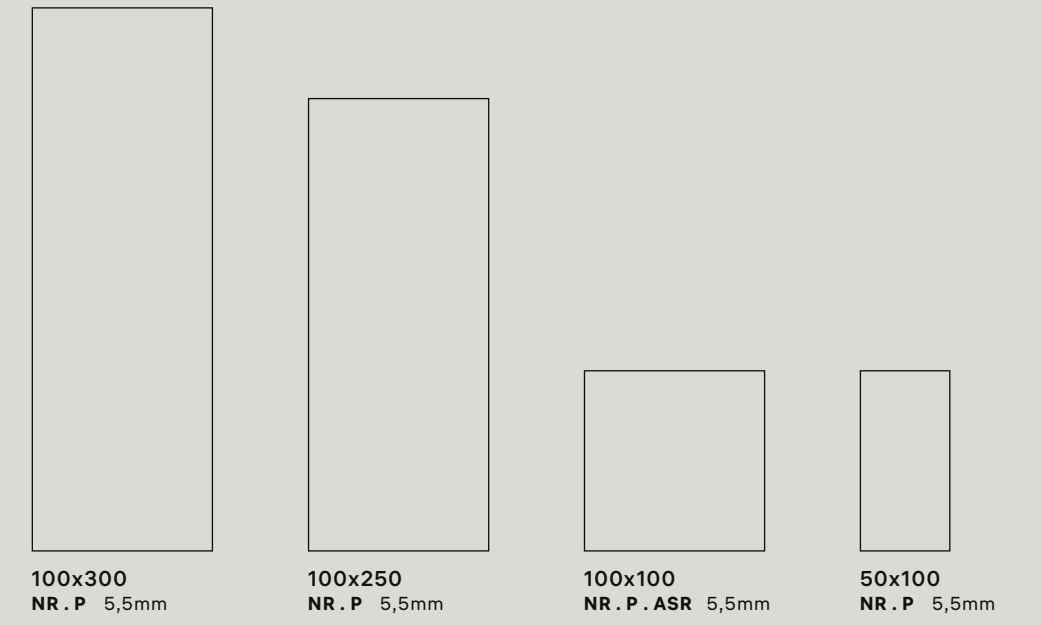

rectified products . produits rectifiés . rektifizierete produkte . produtos retificados



calacatta LPT1 corinthian beige LPT2 travertino grey LPT3 fior di bosco tortora LPT4 emperador black LPT5

UGL **V2** **R10**
ASR NR . ASR P

PR()TECT®
Antibacterial for Life.

MARGRES
CERAMIC TILES

271

general catalogue . 2024

index —

colour map —

collections —

linea collections

- cosmos
- endless
- magnetic
- prestige**
- pure stone
- slabstone
- subway
- time 2.0
- tool

useful information —



corinthian beige LPT2 100x300 NR . 100x100 NR . emperador black LPT5 100x300 P

272

general catalogue . 2024



travertino grey LPT3 100x300 NR . 100x100 NR

273

general catalogue . 2024

index

colour map

collections

linea collections

cosmos

endless

magnetic

prestige

pure stone

slabstone

subway

time 2.0

tool

useful information

LEVEL 01 >
MEN



274

general catalogue, 2024

275

general catalogue, 2024

linea prestige
collection

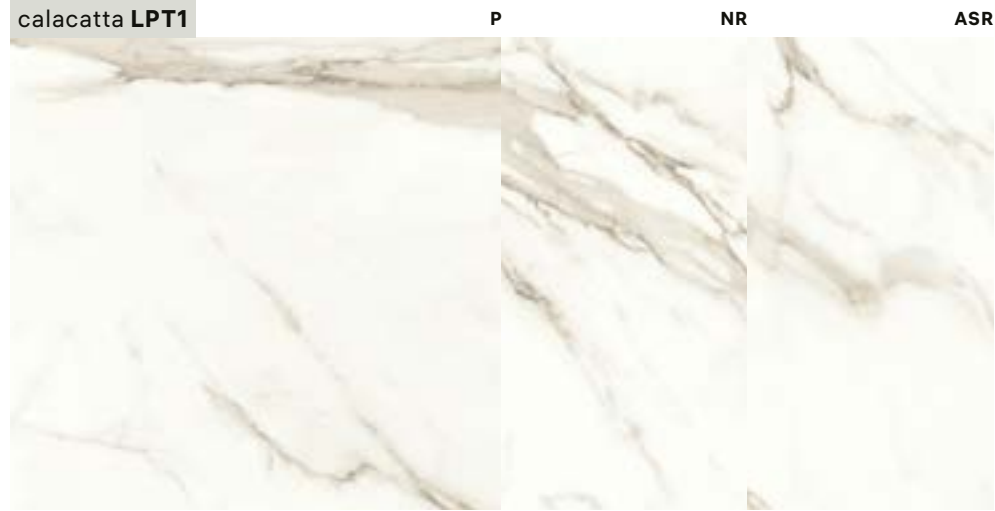

| LINEA | | | | | |
|-----------------------|-------|-----|-----|---------|--|
| 50x100 . 19,6"x39,4" | 5,5mm | NR | - | M3-1930 | |
| | 5,5mm | P | - | M3-2330 | |
| 100x100 . 39,4"x39,4" | 5,5mm | ASR | R10 | M3-2730 | |
| | 5,5mm | NR | - | M3-2730 | |
| 100x250 . 39,4"x98,4" | 5,5mm | NR | - | M3-3530 | |
| | 5,5mm | P | - | M3-3830 | |
| 100x300 . 39,4"x118" | 5,5mm | NR | - | M3-4230 | |
| | 5,5mm | P | - | M3-4630 | |



| LINEA | | | | | |
|-----------------------|-------|----|---|---------|--|
| 50x100 . 19,6"x39,4" | 5,5mm | NR | - | M3-1930 | |
| | 5,5mm | P | - | M3-2330 | |
| 100x100 . 39,4"x39,4" | 5,5mm | NR | - | M3-2730 | |
| | 5,5mm | P | - | M3-3130 | |
| 100x250 . 39,4"x98,4" | 5,5mm | NR | - | M3-3530 | |
| | 5,5mm | P | - | M3-3830 | |
| 100x300 . 39,4"x118" | 5,5mm | NR | - | M3-4230 | |
| | 5,5mm | P | - | M3-4630 | |



| LINEA | | | | | |
|-----------------------|-------|----|---|---------|--|
| 50x100 . 19,6"x39,4" | 5,5mm | NR | - | M3-1930 | |
| | 5,5mm | P | - | M3-2330 | |
| 100x100 . 39,4"x39,4" | 5,5mm | NR | - | M3-2730 | |
| | 5,5mm | P | - | M3-3130 | |
| 100x250 . 39,4"x98,4" | 5,5mm | NR | - | M3-3530 | |
| | 5,5mm | P | - | M3-3830 | |
| 100x300 . 39,4"x118" | 5,5mm | NR | - | M3-4230 | |
| | 5,5mm | P | - | M3-4630 | |

linea prestige
collection



| LINEA | | | | | |
|-----------------------|-------|----|---|---------|--|
| 50x100 . 19,6"x39,4" | 5,5mm | NR | - | M3-1930 | |
| | 5,5mm | P | - | M3-2330 | |
| 100x100 . 39,4"x39,4" | 5,5mm | NR | - | M3-2730 | |
| | 5,5mm | P | - | M3-3130 | |
| 100x250 . 39,4"x98,4" | 5,5mm | NR | - | M3-3530 | |
| | 5,5mm | P | - | M3-3830 | |
| 100x300 . 39,4"x118" | 5,5mm | NR | - | M3-4230 | |
| | 5,5mm | P | - | M3-4630 | |



| LINEA | | | | | |
|-----------------------|-------|----|---|---------|--|
| 50x100 . 19,6"x39,4" | 5,5mm | NR | - | M3-1930 | |
| | 5,5mm | P | - | M3-2330 | |
| 100x100 . 39,4"x39,4" | 5,5mm | NR | - | M3-2730 | |
| | 5,5mm | P | - | M3-3130 | |
| 100x250 . 39,4"x98,4" | 5,5mm | NR | - | M3-3530 | |
| | 5,5mm | P | - | M3-3830 | |
| 100x300 . 39,4"x118" | 5,5mm | NR | - | M3-4230 | |
| | 5,5mm | P | - | M3-4630 | |

index

colour map

collections

linea collections

cosmos

endless

magnetic

prestige

pure stone

slabstone

subway

time 2.0

tool

useful information

Products with a polished finish are more sensitive to abrasion and stains, what requires special conditions. Please see page 328 in chapter 09.
Les produits à finition polie sont plus sensibles à l'abrasion et aux taches, ce qui requiert des conditions particulières. Veuillez-vous consulter la page 328 du chapitre 09.
Produkte mit einer polierten Oberfläche sind empfindlicher gegen Abrieb und Fleckenbildung, was besondere Bedingungen erfordert. Bitte beachten Sie Seite 328 in Kapitel 09.
Os produtos com acabamento polido são mais sensíveis à abrasão e às manchas, o que requer condições especiais. Por favor consulte a página 328 no capítulo 09.

PROTECT

Antibacterial for Life.

Available only in natural rectified and polished finishes.
Uniquement disponible dans les finitions naturel rectifié et poli.
Nur auf rektifiziert naturbelassen und poliert erhältlich.
Disponível unicamente nos acabamentos natural retificado e polido.



278

general catalogue . 2024

white LSL1 50x100 . 100x300 NR . beige LSL2 50x100 . 100x100 NR . tortora LSL3 50x100 . 100x100 NR

LAMINATED
PORCELAIN
STONEWARE

linea slabstone

collection —
P. 175

↓
DOWNLOAD
CATALOGUE

↓
DOWNLOAD
TECHNICAL
FEATURES

🌐
VIEW
ONLINE

↓
DOWNLOAD
BIM



100x300
NR 3,5mm

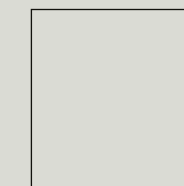

100x100
NR 3,5mm



50x100
NR 3,5mm

rectified products . produits rectifiés . rektifizierete produkte . produtos retificados



white
LSL1

beige
LSL2

tortora
LSL3

light grey
LSL4

grey
LSL5

UGL V2 R9 NR

PR()TECT®

Antibacterial for Life.

MARGRES
CERAMIC TILES

index —

colour map —

collections —

linea collections —

cosmos

endless

magnetic

prestige

pure stone

slabstone

subway

time 2.0

tool

useful information —

279

general catalogue . 2024



280

general catalogue . 2024



281

general catalogue . 2024

grey LSL5 100x300 NR . light grey LSL4 100x300 NR . 100x100 NR

index

colour map

collections

linea collections

cosmos

endless

magnetic

prestige

pure stone

slabstone

subway

time 2.0

tool

useful information

linea slabstone

collection

white LSL1

NR



LINEA

| | | | | |
|-----------------------|-------|----|----|---------|
| 50x100 . 19,6"x39,4" | 3,5mm | NR | R9 | M3-0930 |
| 100x100 . 39,4"x39,4" | 3,5mm | NR | R9 | M3-1230 |
| 100x300 . 39,4"x118" | 3,5mm | NR | R9 | M3-1530 |

beige LSL2

NR



LINEA

| | | | | |
|-----------------------|-------|----|----|---------|
| 50x100 . 19,6"x39,4" | 3,5mm | NR | R9 | M3-0930 |
| 100x100 . 39,4"x39,4" | 3,5mm | NR | R9 | M3-1230 |
| 100x300 . 39,4"x118" | 3,5mm | NR | R9 | M3-1530 |

tortora LSL3

NR



LINEA

| | | | | |
|-----------------------|-------|----|----|---------|
| 50x100 . 19,6"x39,4" | 3,5mm | NR | R9 | M3-0930 |
| 100x100 . 39,4"x39,4" | 3,5mm | NR | R9 | M3-1230 |
| 100x300 . 39,4"x118" | 3,5mm | NR | R9 | M3-1530 |

linea slabstone

collection

light grey LSL4

NR



LINEA

| | | | | |
|-----------------------|-------|----|----|---------|
| 50x100 . 19,6"x39,4" | 3,5mm | NR | R9 | M3-0930 |
| 100x100 . 39,4"x39,4" | 3,5mm | NR | R9 | M3-1230 |
| 100x300 . 39,4"x118" | 3,5mm | NR | R9 | M3-1530 |

LINEA

| | | | | |
|-----------------------|-------|----|----|---------|
| 50x100 . 19,6"x39,4" | 3,5mm | NR | R9 | M3-0930 |
| 100x100 . 39,4"x39,4" | 3,5mm | NR | R9 | M3-1230 |
| 100x300 . 39,4"x118" | 3,5mm | NR | R9 | M3-1530 |

grey LSL5

NR



linea collections

- cosmos
- endless
- magnetic
- prestige
- pure stone
- slabstone**
- subway
- time 2.0
- tool

useful information



white LSW1 100x300 NR . smoke LSW4 100x100 NR

LAMINATED
PORCELAIN
STONEWARE

linea subway

collection —
P. 191

↓
DOWNLOAD
CATALOGUE

↓
DOWNLOAD
TECHNICAL
FEATURES

🌐
VIEW
ONLINE

▶
ENJOY THE
VIDEO



100x300
NR 3,5mm

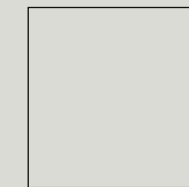

100x100
NR 3,5mm



50x100
NR 3,5mm

rectified products . produits rectifiés . rektifizierte produkte . produtos retificados



white
LSW1

ash
LSW2

clay
LSW3

smoke
LSW4

UGL V2 R9 NR

PR()TECT®

Antibacterial for Life.

MARGRES
CERAMIC TILES

index —

colour map —

collections —

linea collections —

cosmos

endless

magnetic

prestige

pure stone

slabstone

subway

time 2.0

tool

useful information —



288



289

index

colour map

collections

linea collections

cosmos

endless

magnetic

prestige

pure stone

slabstone

subway

time 2.0

tool

useful information



290

general catalogue . 2024



291

general catalogue . 2024

clay LSW3 100x300 . 50x100 NR . clay SW3 60x60 E ASR

index

colour map

collections

linea collections

cosmos

endless

magnetic

prestige

pure stone

slabstone

subway

time 2.0

tool

useful information

linea subway

collection

white LSW1



NR

LINEA

| | | | | |
|-----------------------|-------|----|----|---------|
| 50x100 . 19,6"x39,4" | 3,5mm | NR | R9 | M3-0930 |
| 100x100 . 39,4"x39,4" | 3,5mm | NR | R9 | M3-1230 |
| 100x300 . 39,4"x118" | 3,5mm | NR | R9 | M3-1530 |

clay LSW3



NR

LINEA

| | | | | |
|-----------------------|-------|----|----|---------|
| 50x100 . 19,6"x39,4" | 3,5mm | NR | R9 | M3-0930 |
| 100x100 . 39,4"x39,4" | 3,5mm | NR | R9 | M3-1230 |
| 100x300 . 39,4"x118" | 3,5mm | NR | R9 | M3-1530 |

linea subway

collection

ash LSW2



NR

LINEA

| | | | | |
|-----------------------|-------|----|----|---------|
| 50x100 . 19,6"x39,4" | 3,5mm | NR | R9 | M3-0930 |
| 100x100 . 39,4"x39,4" | 3,5mm | NR | R9 | M3-1230 |
| 100x300 . 39,4"x118" | 3,5mm | NR | R9 | M3-1530 |

smoke LSW4



NR

LINEA

| | | | | |
|-----------------------|-------|----|----|---------|
| 50x100 . 19,6"x39,4" | 3,5mm | NR | R9 | M3-0930 |
| 100x100 . 39,4"x39,4" | 3,5mm | NR | R9 | M3-1230 |
| 100x300 . 39,4"x118" | 3,5mm | NR | R9 | M3-1530 |

index

colour map

collections

linea collections

cosmos

endless

magnetic

prestige

pure stone

slabstone

subway

time 2.0

tool

useful information



294





general catalogue . 2024

silver LT26 100x100 NR

LAMINATED
PORCELAIN
STONEWARE

linea time 2.0

collection —
P. 201

- 
 DOWNLOAD
CATALOGUE
- 
 DOWNLOAD
TECHNICAL
FEATURES
- 
 VIEW
ONLINE
- 
 DOWNLOAD
BIM

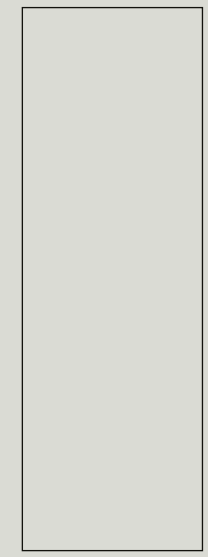

100x300
NR 3,5mm

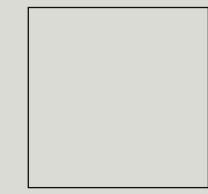

100x100
NR 3,5mm



50x100
NR 3,5mm

rectified products . produits rectifiés . rektifizierete produkte . produtos retificados

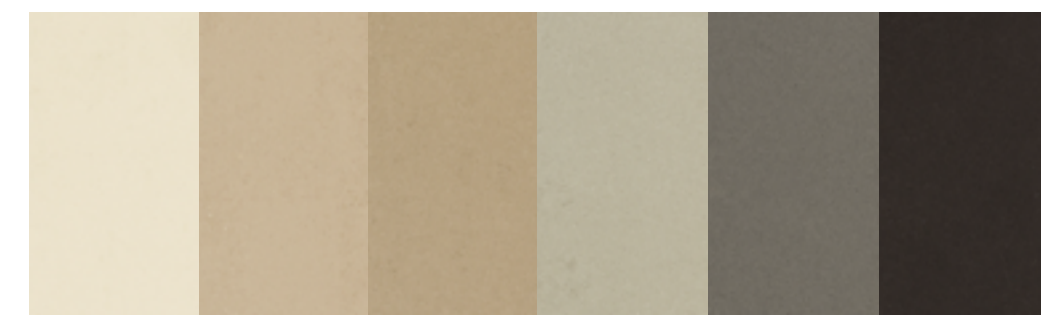

snow LT21 cream LT23 beige LT24 silver LT26 carbon LT28 black LT29

UGL **V1** **R9** 
NR

PR()TECT®
Antibacterial for Life.

MARGRES
CERAMIC TILES

295

general catalogue . 2024

index —

colour map —

collections —

linea collections —

cosmos

endless

magnetic

prestige

pure stone

slabstone

subway

time 2.0 —

tool

useful information —

linea time 2.0

— collection

linea time 2.0

— collection

index



colour map



collections



linea collections



cosmos

endless

magnetic

prestige

pure stone

slabstone

subway

time 2.0

tool

useful information



296

297

general catalogue . 2024

general catalogue . 2024

black LT29 100x100 NR

linea time 2.0

collection



snow LT21 100x100 . cream LT23 100x300 NR

linea time 2.0

collection



cream LT23 50x100 NR

index

colour map

collections

linea collections

cosmos

endless

magnetic

prestige

pure stone

slabstone

subway

time 2.0

tool

useful information

linea time 2.0

collection

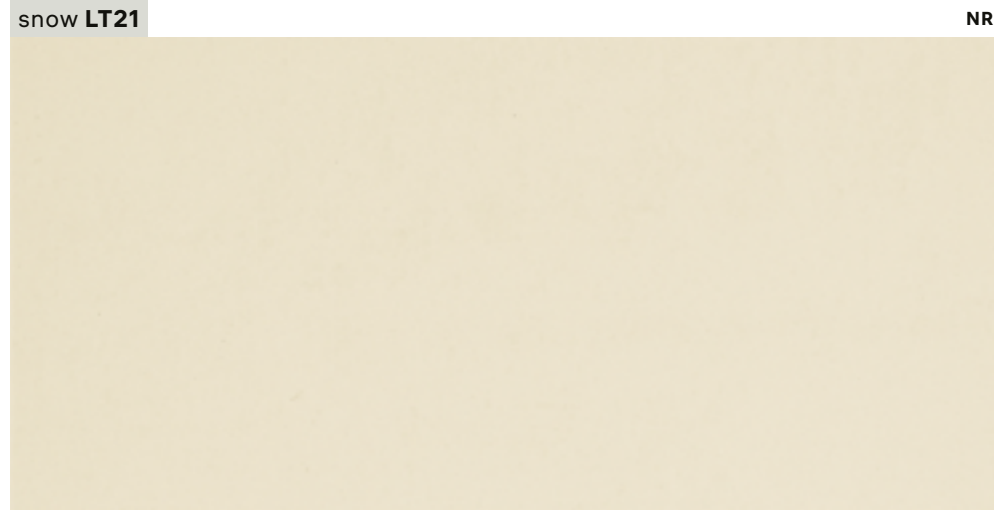

snow LT21

NR

LINEA

| | | | | |
|-----------------------|-------|----|----|---------|
| 50x100 . 19,6"x39,4" | 3,5mm | NR | R9 | M3-0930 |
| 100x100 . 39,4"x39,4" | 3,5mm | NR | R9 | M3-1230 |
| 100x300 . 39,4"x118" | 3,5mm | NR | R9 | M3-1530 |

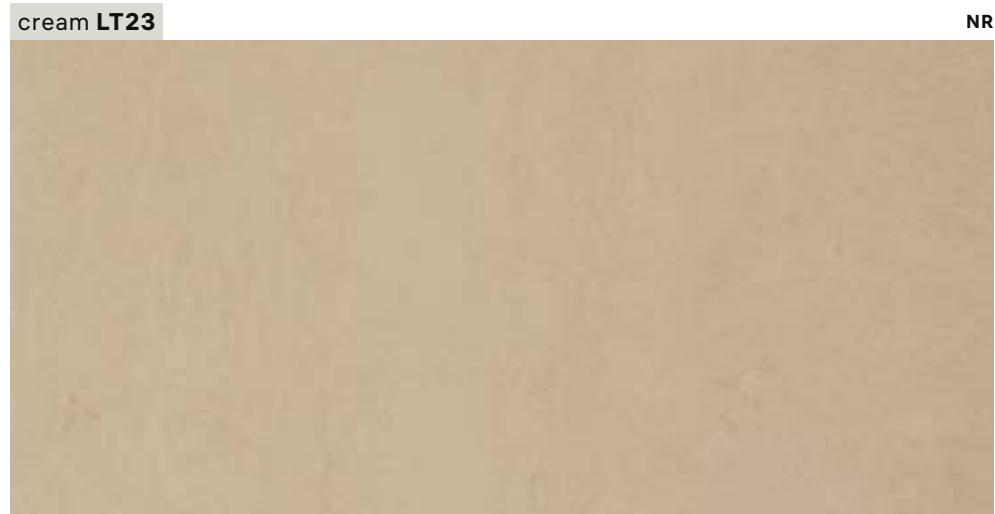

cream LT23

NR

LINEA

| | | | | |
|-----------------------|-------|----|----|---------|
| 50x100 . 19,6"x39,4" | 3,5mm | NR | R9 | M3-0930 |
| 100x100 . 39,4"x39,4" | 3,5mm | NR | R9 | M3-1230 |
| 100x300 . 39,4"x118" | 3,5mm | NR | R9 | M3-1530 |

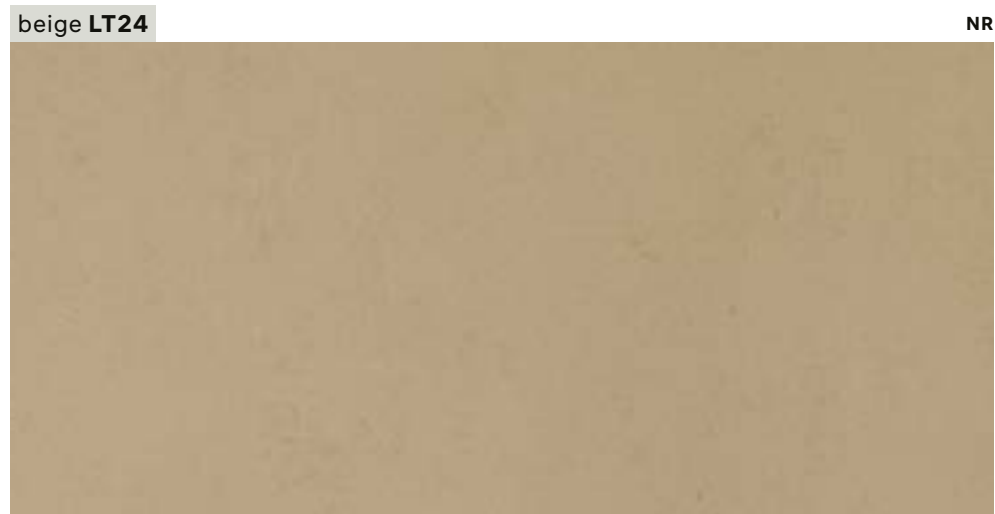

beige LT24

NR

LINEA

| | | | | |
|-----------------------|-------|----|----|---------|
| 50x100 . 19,6"x39,4" | 3,5mm | NR | R9 | M3-0930 |
| 100x100 . 39,4"x39,4" | 3,5mm | NR | R9 | M3-1230 |
| 100x300 . 39,4"x118" | 3,5mm | NR | R9 | M3-1530 |

linea time 2.0

collection

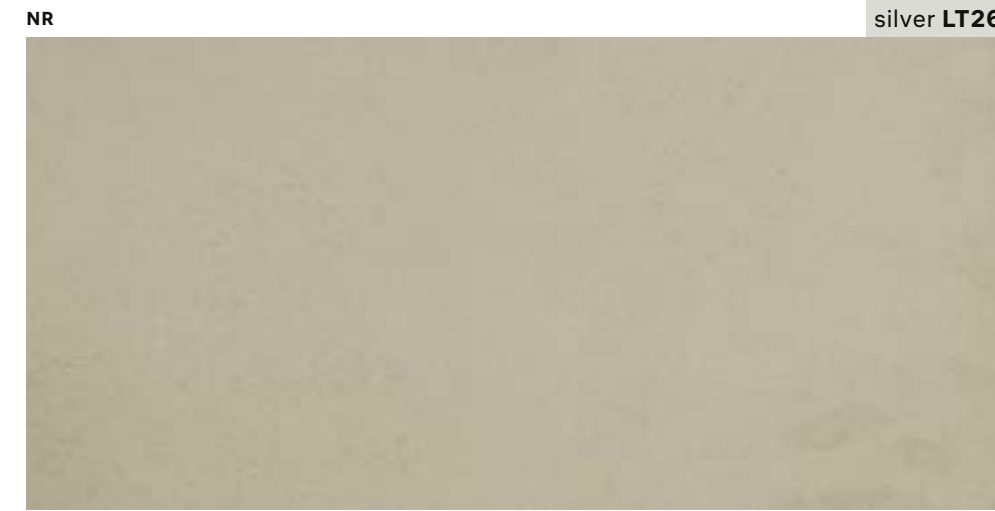

NR

silver LT26

LINEA

| | | | | |
|-----------------------|-------|----|----|---------|
| 50x100 . 19,6"x39,4" | 3,5mm | NR | R9 | M3-0930 |
| 100x100 . 39,4"x39,4" | 3,5mm | NR | R9 | M3-1230 |
| 100x300 . 39,4"x118" | 3,5mm | NR | R9 | M3-1530 |

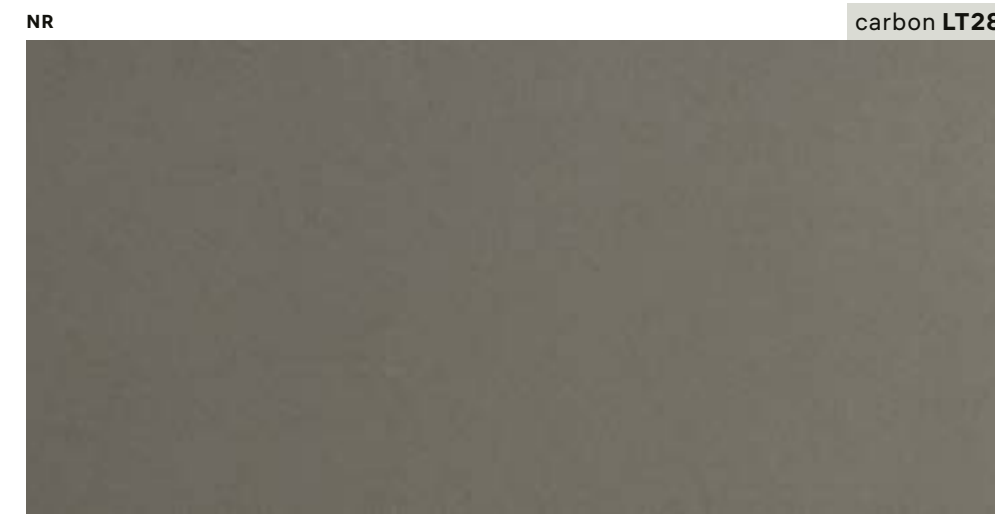

NR

carbon LT28

LINEA

| | | | | |
|-----------------------|-------|----|----|---------|
| 50x100 . 19,6"x39,4" | 3,5mm | NR | R9 | M3-0930 |
| 100x100 . 39,4"x39,4" | 3,5mm | NR | R9 | M3-1230 |
| 100x300 . 39,4"x118" | 3,5mm | NR | R9 | M3-1530 |

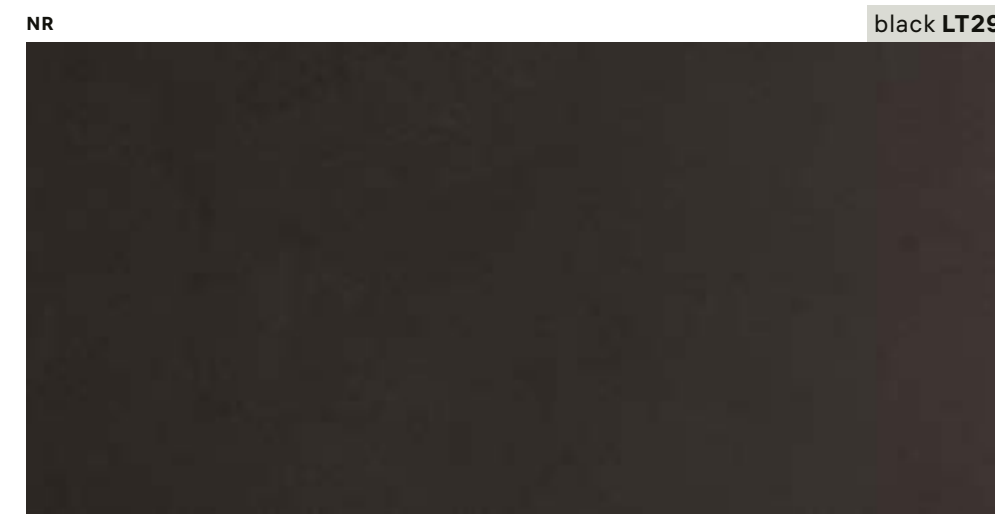

NR

black LT29

LINEA

| | | | | |
|-----------------------|-------|----|----|---------|
| 50x100 . 19,6"x39,4" | 3,5mm | NR | R9 | M3-0930 |
| 100x100 . 39,4"x39,4" | 3,5mm | NR | R9 | M3-1230 |
| 100x300 . 39,4"x118" | 3,5mm | NR | R9 | M3-1530 |

index

colour map

collections

linea collections

cosmos

endless

magnetic

prestige

pure stone

slabstone

subway

time 2.0

tool

useful information

300

301

general catalogue . 2024

general catalogue . 2024

useful information

informations utiles . technische information . informações úteis —

calibers
calibres P. 336
kaliber
calibres

certification
certification P. 310
zertifizierung
certificação

general sales conditions
conditions générales de vente P. 340
allgemeine verkaufsbedingungen
condições gerais de venda

important notes
notes importantes P. 347
wichtige hinweise
notas importantes

margres green P. 308

laying suggestions
suggestions de pose P. 339
anwendungsvorschläge
sugestões de aplicação

outdoor extra thick P. 318

package
emballage P. 334
verpackung
embalagem

pr()tect P. 304

symbols
symbologie P. 338
zeichen
simbologia

technical information
information technique P. 322
technische information
informação técnica

think zero P. 306

303

general catalogue . 2024

index —

colour map —

collections —

linea collections —

useful information —

calibers

certification

general sales
conditions

important notes

laying suggestions

magres green

outdoor extra thick

package

pr()tect

symbols

technical information

think zero

PR()TECT®

Antibacterial for Life.

An exclusive line of extremely high performance antimicrobial floor and wall tiles, designed for healthy, safe and protected living spaces.
Une ligne exclusive de sols et revêtements antibactériens aux performances très élevées, pour un habitat sain, sûr et protégé.
Eine exklusive Linie an hochwertigen Fußböden und antibakteriellen Wandverkleidungen, für ein gesundes, sicheres und geschütztes Leben.
Uma linha exclusiva de pavimentos e revestimentos antimicrobianos de altíssima performance, projetada para ambientes saudáveis, seguros e protegidos.



powerful action

eliminates up to 99.9% of bacteria and prevents their reproduction

action puissante

élimine jusqu'à 99,9% des bactéries et empêche leur prolifération

leistungsstarke wirkung

eliminiert bis zu 99,9% Bakterien und ihre Verbreitung verhindern.

ação potente

elimina até 99,9% das bactérias e impede a sua reprodução



continuous protection

always active, 24 hours a day, with or without sunlight

protection continue

toujours actif, 24 heures sur 24 avec ou sans lumière naturelle

dauerschutz

immer aktiv, Rund um die Uhr, mit oder ohne Sonnenlicht

proteção contínua

permanente ativo, 24 horas por dia, com ou sem luz solar



eternal effectiveness

thanks to technology integrated into the product

efficacité permanente

grâce à la technologie intégrée dans le produit

dauerhafte wirksamkeit

dank der im Produkt integrierten Technologie

eficácia permanente

graças à tecnologia incorporada no produto



guaranteed quality

by the partnership with Microban®

qualité garantie

en partenariat avec Microban®

garantierte qualität

dank der Partnership mit Microban®

qualidade garantida

em parceria com a Microban®



the safest place in the world

continuous active antibacterial action

- We have chosen Microban®, the global leader in antibacterial technology, to make our tiles even safer.
- There are more bacteria on one hand than people on the Earth.
- Bacterial growth can double in number every 20 minutes on unprotected surfaces.

Floors in areas with high levels of pedestrian traffic, such as schools, offices, hospitals and public buildings are ideal places for microbial and bacterial growth, but our homes, despite daily cleaning, can also be contaminated by germs and bacteria from outside.

Margres always offers the highest quality products, together with unparalleled beauty and cutting-edge solutions.

Today, thanks to ongoing work at the Panariagroup Research Centre and a prestigious agreement with the global leader in antibacterial technology Microban®, we are proud to announce that Margres porcelain stoneware, produced with Microban® technology, are designed with something more than beauty and durability in mind: biological health and safety for our living, leisure and working environments.

Thanks to built-in technology based on silver, our tiles are protected by an innovative antibacterial shield that eliminates up to 99.9% of bacteria on surfaces and guarantees long-lasting protection against wear and tear, climatic conditions and repeated cleans in any usage environment.

Microban silver technology is notified with the Biocidal Products Directive (BPD) under the appropriate product types as required by the EU Biocidal Products Directive, 98/8/EC.

In addition, Microban® technology is active 24 hours a day, guaranteeing continuous protection day and night, keeping tiles more hygienic in between cleans.

l'endroit le plus sûr au monde

action antibactérienne active en permanence

- Nous avons choisi Microban®, le leader mondial en technologie antibactérienne, pour rendre nos carrelages encore plus sûrs.
- Il y a plus de bactéries sur une main que d'habitants sur la terre.
- Sur les surfaces non protégées, la prolifération des bactéries peut se multiplier par deux toutes les 20 minutes.

Les sols des zones à fort passage de piétons, comme par exemple, les écoles, bureaux, hôpitaux et bâtiments publics, sont des endroits qui se prêtent à la prolifération microbienne et bactérienne, mais, malgré un nettoyage quotidien, nos foyers peuvent aussi être contaminés par des germes et des bactéries venant de l'extérieur.

Margres propose toujours des produits de la plus haute qualité, alliés à une beauté hors pair et des solutions à la pointe de la technologie.

À l'heure actuelle, grâce aux travaux continus du Panariagroup Research Centre, et à un contrat prestigieux avec Microban®, le leader mondial en technologie antibactérienne, nous sommes fiers d'annoncer que les carrelages en grès cérame pleine masse Margres, produits en incorporant la technologie Microban®, sont conçus en recherchant quelque chose de plus que l'esthétique et la durabilité, à savoir la santé et la sûreté biologiques pour nos espaces de vie, de loisirs et de travail.

Grâce à la technologie incorporée basée sur l'argent, nos carrelages sont protégés par un bouclier antibactérien innovateur qui élimine jusqu'à 99,9% des bactéries sur les surfaces et garantit une protection durable contre l'usure, les conditions climatiques et les nettoyages à répétition dans tous les lieux d'utilisation.

La technologie à base d'argent Microban est notifiée avec la Directive sur les produits biocides (Biocidal Products Directive, BPD) sous les types de produits appropriés tel que requis par la Directive européenne sur les produits biocides, 98/8/EC.

Par ailleurs, la technologie Microban® reste active 24 heures par jour, ce qui garantit une protection ininterrompue jour et nuit, maintenant les carrelages dans un état plus hygiénique entre les nettoyages.

der sicherste ort der welt

die aktive antibakterielle aktion geht weiter

- Wir haben uns für Microban®, den Weltmarktführer in antibakterieller Technologie entschieden, um unsere Fliesen noch sicherer zu machen.
- In der Fläche einer Hand leben mehr Bakterien als Menschen auf der Erde.
- Bakterielles Wachstum kann sich auf ungeschützten Oberflächen alle 20 Minuten verdoppeln.

Fußböden in Bereichen mit hohem Fußgängeraufkommen wie Schulen, Büros, Krankenhäusern und öffentlichen Gebäuden sind ideale Orte für mikrobisches und bakterielles Wachstum, und sogar unsere Wohnungen können trotz täglicher Reinigung durch Erreger und Bakterien von außen verseucht sein. Margres-Produkte bieten immer höchste Qualität in Verbindung mit unerreichter Schönheit und bahnbrechenden Lösungen.

Heute geben wir, dank der andauernden Forschungsarbeit des Panariagroup Research Centre und einem Übereinkommen mit Microban®, dem Weltmarktführer in antibakterieller Technologie bekannt, dass die anhand der Microban® -Technologie gefertigten Margres-Fliesen mehr als nur Schönheit und Strapazierfähigkeit verkörpern: Gesundheit und biologische Sicherheit für unsere Wohn-, Freizeit- und Arbeitsbereiche.

Dank der silberbasierten Technologie sind unsere Fliesen durch eine innovative antibakterielle Barriere geschützt, die bis zu 99,9% der Bakterien an der Oberfläche eliminiert und einen dauerhaften Schutz gegen Abnutzung, Witterung und wiederholte Reinigung in jeglichem Einsatzumfeld bietet.

Die Microban Silbertechnologie wurde gemäß der Anforderungen der EU-Richtlinie für Biozid-Produkte (98/8/CE) unter dem Schutz der Richtlinie für Biozid-Produkte (BPD, Biocidal Product Directive) registriert.

Außerdem ist die Microban®-Technologie 24 Stunden am Tag aktiv und garantiert auf diese Weise Tag- und Nachtschutz, indem sie die Fliesen zwischen den Putzvorgängen hygienisch hält.

o local mais seguro do mundo

ação antibacteriana ativa contínua

- Escolhemos o Microban®, o líder global em tecnologia antibacteriana, para tornar os nossos mosaicos ainda mais seguros.
- Há mais bactérias numa mão do que pessoas na Terra.
- O crescimento bacteriano pode duplicar de número a cada 20 minutos, em superfícies não protegidas.

Os pavimentos das áreas com elevados níveis de tráfego pedestre, tais como escolas, escritórios, hospitais e edifícios públicos são locais ideais para o crescimento microbiano e bacteriano, mas as nossas casas, apesar da limpeza diária, também podem ser contaminadas por germes e bactérias do exterior. A Margres oferece sempre produtos da mais elevada qualidade, aliados a uma beleza inigualável e soluções de vanguarda.

Atualmente, graças ao trabalho contínuo no Panariagroup Research Centre de um acordo prestigioso com a Microban®, o líder global em tecnologia antibacteriana, temos o orgulho de anunciar que os mosaicos Margres, produzidos com a tecnologia Microban®, são concebidos tendo em mente algo mais do que a beleza e durabilidade: ainda mais saúde e segurança biológica para os nossos ambientes domésticos, de lazer e trabalho.

Grças à tecnologia incorporada com base de prata, os nossos mosaicos estão protegidos por uma barreira antibacteriana inovadora que elimina até 99,9% das bactérias na superfície e garante uma proteção duradoura contra o desgaste, condições climáticas e limpezas repetidas em qualquer ambiente de utilização. A tecnologia de prata Microban foi registada junto da Diretiva de Produtos Biocidas (BPD, Biocidal Product Directive), sob os tipos de produto adequados conforme requerido pela Diretiva de Produtos Biocidas da UE, 98/8/CE. Além disso, a tecnologia Microban® está ativa 24 horas por dia, garantindo proteção contínua dia e noite, mantendo os mosaicos mais higiénicos entre as limpezas.

index

colour map

collections

linea collections

useful information

calibers

certification

general sales conditions

important notes

laying suggestions

magres green

outdoor extra thick

package

pr()tect

symbols

technical information

think zero

an action to be tangible has to start from the basics, from the spaces we live in, from the decisions we make

At the global level, buildings, homes, and the construction sector are today responsible for approximately 36% of the world's total energy consumption and 37% of all CO2 emissions related to energy*. Within this context, the construction sector can and must contribute to accelerating decarbonisation and developing alternative, low-CO2 emission, solutions in an effort to achieve zero emissions by 2050. That's why choosing the right materials for residential, commercial, and public spaces is instrumental to decreasing our environmental impact. Today, clients and designers must be increasingly meticulous when selecting construction materials and techniques, if there is to be any hope of achieving the Paris Agreement's objective of limiting global warming to 1.5°C. *2021 GLOBAL STATUS REPORT FOR BUILDINGS AND CONSTRUCTION, Global Alliance for Buildings and Constructions

Pour être tangible, une action doit partir de la base, des espaces dans lesquels nous vivons, des décisions que nous prenons

A l'échelle mondiale, les bâtiments, les habitations et le secteur de la construction sont aujourd'hui responsables d'environ 36 % de la consommation totale d'énergie dans le monde et de 37 % de toutes les émissions de CO2 liées à l'énergie*. Dans ce contexte, le secteur de la construction peut et doit contribuer à l'accélération de la décarbonisation et au développement de solutions alternatives à faible émission de CO2, dans le but d'atteindre l'objectif de zéro émission d'ici 2050. C'est pourquoi choisir les bons matériaux pour les espaces résidentiels, commerciaux et publics est essentiel pour réduire notre impact sur l'environnement. Aujourd'hui, les maîtres d'ouvrage et les concepteurs doivent être de plus en plus méticuleux dans le choix des matériaux et des techniques de construction, s'ils veulent avoir un espoir d'atteindre l'objectif de l'Accord de Paris, qui consiste à limiter le réchauffement de la planète à 1,5°C. *RAPPORT D'ÉTAPE GLOBAL 2021 SUR LES BÂTIMENTS ET LA CONSTRUCTION, Alliance mondiale pour les bâtiments et les constructions.

we reduce the distance between us and zero impact, reducing everything in between

nous réduisons la distance qui nous sépare de l'impact zéro, en réduisant tout ce qui se trouve entre les deux . wir verringern den Abstand zwischen uns und der Nullbelastung und reduzieren alles, was dazwischen liegt. diminuímos a distância entre nós e o impacto zero, reduzindo tudo o que está no meio



-65%

consumption of raw materials
consommation de matières premières
Verbrauch von Rohstoffen
consumo de matérias primas



-80%

consumption of water
consommation d'eau
Wasserverbrauch
consumo de água



-30%

consumption of energie
consommation d'énergie
Energieverbrauch
o consumo de energia



-30%

CO2 emissions in the atmosphere
CO2 émissions dans l'atmosphère
CO2 Emissionen in die Atmosphäre
CO2 emissões na atmosfera.



-66%

pollution caused by transport
pollution produite par les transports
transportbedingte Umweltverschmutzung
poluição causada pelos transportes

The data refers to ultra-thin slabs when compared to standard-thickness porcelain stoneware tile . Les données se rapportent aux dalles ultrafines par rapport aux carreaux en grès cérame d'épaisseur standard . Die Daten beziehen sich auf ultradünne Platten im Vergleich zu Fliesen aus Feinsteinzeug mit Standarddicke . Os dados reportam-se a lajes ultrafinas, quando comparadas com mosaicos em grés porcelânico de espessura

our ultra-thin slabs. the most sustainable ceramic surface in the world with co2 compensated 100%

Our ultra-thin slabs are born sustainable, but we didn't stop there. Because we've worked to reduce the CO2 emissions generated by their production and compensate for residual emissions as well. To go beyond. To achieve a zero-impact production, well beyond legal requirements. Thus creating ultra-thin slabs that compensate for 100% of their CO2 emissions is the world's most sustainable ceramic surface! The thinnest tile on the market, at 3mm thick, is a testament to Panariagroup's leadership in the innovation of ceramic's natural sustainability.

unsere ultradünnen Platten. die nachhaltigste keramische oberfläche der welt mit 100% CO2-Kompensation

Unsere ultradünnen Platten werden bereits nachhaltig produziert, aber das war noch nicht alles. Denn wir haben daran gearbeitet, die bei ihrer Herstellung entstehenden CO2-Emissionen zu reduzieren und auch die verbleibenden Emissionen zu kompensieren. Um darüber hinauszugehen. Um eine umweltfreundliche Null-Emissionen-Produktion zu erreichen, die weit über die gesetzlichen Anforderungen hinausgeht. So haben wir ultradünne Platten geschaffen, die 100 % ihrer CO2-Emissionen kompensieren: die nachhaltigste Keramikoberfläche der Welt! Die dünnste Fliese auf dem Markt mit einer Dicke von 3 mm ist ein Beweis für die innovationsführende Rolle der Panariagroup im Bereich der natürlichen Nachhaltigkeit von Keramik.

nos dalles ultra-minces. la surface céramique la plus durable au monde avec une compensation de CO2 à 100%.

Nos dalles ultra-minces sont déjà produites de manière durable, mais nous ne nous sommes pas arrêtés là. Car nous avons travaillé pour réduire les émissions de CO2 générées par leur production et compenser également les émissions résiduelles. Pour aller plus loin. Pour atteindre une production à impact zéro, en allant bien au-delà des exigences légales. En créant ainsi des dalles ultra-minces qui compensent 100 % de leurs émissions de CO2, nous avons créé la surface céramique la plus durable du monde! La mosaïque la plus fine du marché, d'une épaisseur de 3 mm, témoigne du leadership de Panariagroup en matière d'innovation dans le domaine de la durabilité naturelle de la céramique.

as nossas lajes ultrafinas. a superfície cerâmica mais sustentável do mundo, com 100% de compensação de CO2.

As nossas lajes ultrafinas já são produzidas de forma sustentável, mas não nos ficámos por aí, uma vez que trabalhamos no sentido de reduzir as emissões de CO2 geradas pela sua produção e também de compensar as emissões residuais. Para ir mais além. Para alcançar uma produção com impacto zero, ultrapassando largamente os requisitos legais. Assim, a criação de lajes ultrafinas que compensam em 100% as suas emissões de CO2 significa a criação da superfície cerâmica mais sustentável do mundo! O mosaico mais fino do mercado, com 3mm de espessura, é um testemunho da liderança da Panariagroup na inovação da sustentabilidade natural da cerâmica.

Eine Aktion, die greifbar sein soll, muss bei den Grundlagen beginnen, bei den Räumen in denen wir leben, von den Entscheidungen, die wir treffen

Auf globaler Ebene sind Gebäude, Wohnungen und der Bausektor heute für etwa 36 % des weltweiten Gesamtenergieverbrauchs und 37 % aller energiebedingten CO2-Emissionen verantwortlich*. In diesem Zusammenhang kann und muß der Bausektor dazu beitragen, die Dekarbonisierung zu beschleunigen und alternative Lösungen mit geringen CO2-Emissionen zu entwickeln, um bis zum Jahr 2050 Null-Emissionen zu erreichen. Deshalb ist die Wahl der richtigen Materialien für Wohn-, Geschäfts- und öffentliche Räume entscheidend für die Verringerung unserer Umweltbelastung. Heutzutage, müssen Bauherren und Planer bei der Auswahl von Baumaterialien und -techniken immer sorgfältiger vorgehen, wenn das Ziel des Pariser Abkommens, die globale Erwärmung auf 1,5 °C zu begrenzen, erreicht werden soll. *BERICHT ÜBER DIE GLOBALE SITUATION IM JAHR 2021 FÜR GEBÄUDE UND BAUWESEN, Globale Allianz für Gebäude und Bauwesen.

uma ação para ser tangível tem de começar a partir do que é básico, dos espaços em que vivemos, das decisões que tomamos

A nível global, os edifícios, as casas e o setor da construção são hoje em dia responsáveis por aproximadamente 36% do consumo total de energia a nível mundial e por 37% de todas as emissões de CO2 relacionadas com energia*. Neste contexto, o setor da construção pode e tem de contribuir para acelerar a descarbonização e desenvolver soluções alternativas, com baixas emissões de CO2, num esforço para se alcançar zero emissões até 2050. É por isso que a escolha dos materiais corretos para espaços residenciais, comerciais e públicos é fundamental para diminuir o nosso impacto ambiental. Atualmente, os clientes e projetistas têm de ser cada vez mais meticolosos na selecção de materiais e técnicas de construção, para que haja alguma esperança de se alcançar o objetivo do Acordo de Paris de limitar o aquecimento global a 1,5°C. *RELATÓRIO DA SITUAÇÃO GLOBAL EM 2021 RELATIVA A EDIFÍCIOS E CONSTRUÇÃO, Aliança Global para Edifícios e Construções.



inhabit the present live the future

Margres creates ceramic collections to live the present and the future, surrounded by beauty, protected by the quality of an exclusive design of living in total freedom. The same beauty and marvelous harmony that we dream for the world around us.

For this, Margres creates and protects, by reducing to its minimum the environmental impact coming from its activity, through the constant research of the total eco-sustainability in the working environment, on the materials used and in the productive processes, as the obtained environmental certificates demonstrate. We want to contribute for a better world and only what is really eco-sustainable can be considered as development with future vision...

This is our daily commitment and our social responsibility.

| sustainable development | commitments |
|--|---|
| customer services and relationships with other stakeholders | satisfaction of customers and other interested parties, seeking the internationalization of their brands and products in the various markets; |
| continuous improvement | innovation and product development anticipating the expectations of its customers and ensuring the sustainability of the products throughout their life cycle; |
| efficiency | implementation of a culture of operational excellence that maximizes the efficiency of processes; |
| social goals | involvement and motivation of its employees, since they are an important asset for the success of the company; |
| environmental protection | environmental protection, including pollution prevention, contributing to the minimization of environmental impacts, and opting, whenever possible and economically viable, for the best available technologies, in order to improve environmental performance; |
| health, safety and well-being | prevention and minimization of risk to the health and safety of employees in order to contribute to their integrity and quality of life; |
| relationships with society | compliance with the applicable conformity requirements inherent in its activities, products and services. |

habiter le present vivre l'avenir

Margres crée des collections pour vivre le présent et l'avenir, encadrés par la beauté, protégés par la qualité d'un design exclusif à vivre en toute liberté.

La même beauté et la même harmonie dont nous rêvons pour notre monde. C'est pour cette raison que Margres crée et protège en réduisant le plus possible l'impact environnemental de son activité, à travers la recherche permanente de l'équilibre écologique dans l'environnement de travail, dans les matières utilisées et dans le processus productif, comme le démontrent les certifications environnementales obtenues. Nous voulons contribuer à ce que vous viviez dans un monde plus beau, plus écologique donc plus développé et d'avenir. Ceci est notre compromis quotidien et notre responsabilité sociale.

| développement durable | engagements |
|--|--|
| service clientèle et autres parties intéressées | la satisfaction des clients et des autres parties prenantes, cherchant l'internationalisation de ses marques et produits sur les différents marchés; |
| amélioration continue | l'innovation et le développement des produits, avec une prévision des attentes de ses clients, en assurant la durabilité des produits tout au long de leur cycle de vie; |
| efficacité | la mise en œuvre d'une culture d'excellence opérationnelle qui incite à la maximisation de l'efficacité des processus; |
| sociaux | l'implication et la motivation de ses employés car ils constituent un actif essentiel pour la réussite de l'entreprise; |
| protection environnementale | la protection de l'environnement, y compris la prévention de la pollution, contribuant ainsi à minimiser les impacts environnementaux, en optant, lorsque possible et économiquement réalisable, pour la meilleure technologie disponible, afin d'améliorer la performance environnementale; |
| sécurité, santé et bien-être | la prévention et la réduction des risques pour la santé et la sécurité des employés afin de contribuer à leur intégrité et qualité de vie; |
| rapport avec la société | respect des obligations de conformité applicables, inhérentes à ses activités, produits et services. |

in der gegenwart wohnen, in der zukunft leben

Margres produziert Keramik Kollektionen um in der Gegenwart und der Zukunft zu wohnen, vollkommen in Schönheit, ausgestattet mit der Qualität eines exklusiven Designs, damit Sie in Freiheit leben.

Die gleiche Schönheit und wundervolle Harmonie die wir uns für unsere Umwelt wünschen. Das heißt, dass Margres erschafft und schützt, dabei die Umweltbelastung deren Aktivität auf ein Minimum reduziert, mittels der ständigen Forschung nach der totalen Ökonachhaltigkeit an den Produktionsstätten, den benutzten Materialien, und den Herstellungsprozessen, wie die erlangten Umweltzertifikate darlegen. Wir wollen dazu beitragen in einer besseren Welt zu leben, dabei wissen wir, dass die Ökonachhaltigkeit die Zukunftsentwicklung ist ... Es ist unsere tägliche Anstrengung und soziale Verantwortung.

| nachhaltige entwicklung | verpflichtungen |
|--|--|
| kundenbezogene, aber auch für andere beteiligte zu erbringende leistungen | zufriedenheit der kunden und anderer interessierter beteiligten und streben nach internationalisierung der marken und produkte auf den verschiedenen märkten; |
| kontinuierliche verbesserungen | innovation und entwicklung der produkte, wobei die erwartungen der kunden vorweggenommen werden, und sicherung der nachhaltigkeit der produkte über den gesamten lebenszyklus hinweg; |
| effizienz | umsetzung einer kultur der betrieblichen exzellenz, die die maximierung der effizienz der verfahren verstärkt; |
| betriebsbezogen | einbindung und motivation der mitarbeiter, denn sie stellen die bestimmenden aktiva des unternehmens dar; |
| umweltschutz | umweltschutz, einschließlich vermeidung von umweltverschmutzung, der zur minimisierung der umweltauswirkungen beiträgt und wo immer dies möglich und wirtschaftlich vertretbar ist, die besten verfügbaren technologien auswählen, um die umwelleistung zu verbessern; |
| sicherheit, gesundheit und wohlstand | vorbeugung und minimierung der risiken und gefahren für die gesundheit und sicherheit der mitarbeiter, um zur integrität und lebensqualität beizutragen; |
| firnenbezogen | einhaltung der anwendbaren compliance-verpflichtungen, die mit ihren produkten und dienstleistungen verbunden sind. |

habitar o presente viver o futuro

A Margres, cria coleções cerâmicas para habitar o presente e o futuro, plenas de beleza, dotadas da qualidade de um exclusivo design, para viver em liberdade. A mesma beleza e a mesma maravilhosa harmonia que sonhamos para o mundo em nosso redor. Isto é, a Margres, cria e protege, reduzindo ao mínimo o impacto ambiental da sua atividade, por meio da constante pesquisa da total eco sustentabilidade no local de trabalho, nas matérias utilizadas, e nos processos produtivos, como demonstram as certificações ambientais obtidas. Queremos contribuir para que vivamos num mundo melhor, sabendo que a eco sustentabilidade é desenvolvimento olhando para o futuro...

É o nosso esforço quotidiano e a nossa responsabilidade social.

| desenvolvimento sustentável | compromissos |
|---|--|
| serviço ao cliente e restantes partes interessadas | Satisfação dos clientes e restantes partes interessadas, procurando a internacionalização das suas marcas e produtos nos diversos mercados; |
| melhoria contínua | Inovação e desenvolvimento dos produtos antecipando as expectativas dos seus clientes e assegurando a sustentabilidade dos produtos ao longo do seu ciclo de vida; |
| eficiência | Implementação de uma cultura de excelência operacional que potencie a maximização da eficiência dos processos; |
| sociais | Envolvimento e motivação dos seus colaboradores pois constituem um activo determinante para o sucesso da empresa; |
| proteção ambiental | Proteção do ambiente, incluindo a prevenção da poluição, contribuindo para a minimização dos impactos ambientais e optando sempre que possível e economicamente viável pelas melhores tecnologias disponíveis, a fim de melhorar e desempenho ambiental; |
| segurança, saúde e bem-estar | Prevenção e minimização do risco para a saúde e segurança dos colaboradores por forma a contribuir para sua integridade e qualidade de vida; |
| relação com a sociedade | Cumprimento das obrigações de conformidade aplicáveis inerentes às suas atividades, produtos e serviços. |

certification

certification . zertifizierung . certificação



The GREENGUARD brand certifies products that guarantee the highest standards of indoor air quality.

All MARGRES collections in porcelain stoneware, monoporous and laminated stoneware have obtained the GREENGUARD GOLD certification, that is, the UL standard with the strictest limits on VOC (Volatile Organic Compounds) emissions, thus being in a position to guarantee the best health conditions for people who live and dwell in indoor spaces. Therefore, they can be used in environments such as schools and healthcare facilities, frequented by sensitive people, such as children and the elderly.

GREENGUARD GOLD is a widely recognised certification, required by sustainable construction programmes and by design and construction regulations around the world, such as LEED (international) and BREEAM (UK).

La marque GREENGUARD certifie des produits qui garantissent les plus hauts standards de qualité de l'air dans les espaces intérieurs.

Toutes les collections MARGRES en grès cérame, monoporeuse et grès laminé ont obtenu la certification GREENGUARD GOLD, c'est-à-dire, la norme UL avec les limites les plus strictes d'émissions de COV (composés organiques volatils), étant ainsi en mesure de garantir les meilleures conditions sanitaires aux personnes qui vivent et habitent les espaces intérieurs. Ils peuvent donc être utilisés dans des environnements tels que les écoles et les établissements de santé, fréquentés par des personnes sensibles, comme les enfants et les personnes âgées.

GREENGUARD GOLD est une certification largement reconnue et exigée par les programmes de construction durable et les réglementations de conception et de construction dans le monde entier, telles que LEED (international) et BREEAM (Royaume-Uni).

Die Marke GREENGUARD zertifiziert Produkte, die die höchsten Standards der Luftqualität in Innenräumen garantieren.

Alle MARGRES-Kollektionen aus Feinsteinzeug, Monoporös und laminiertem Feinsteinzeug haben die GREENGUARD GOLD-Zertifizierung erhalten, d.h. die UL-Norm mit den strengsten Grenzwerten für FOV-Emissionen (Flüchtiger Organischer Verbindungen) und sind somit in der Lage, die besten Gesundheitsbedingungen für Menschen, die in Innenräumen leben und wohnen, zu gewährleisten. Daher, können sie in Umgebungen wie Schulen und Gesundheitseinrichtungen eingesetzt werden, die von empfindlichen Menschen wie Kindern und älteren Menschen frequentiert werden.

GREENGUARD GOLD ist eine Zertifizierung, die weithin anerkannt und von nachhaltigen Bauprogrammen und Design- und Bauvorschriften auf der ganzen Welt gefordert wird, wie LEED (international) und BREEAM (UK).

A marca GREENGUARD certifica produtos que garantem os mais elevados padrões de qualidade do ar em espaços interiores.

Todas as coleções MARGRES em grés porcelânico, monoporosa e grés laminado obtiveram a certificação GREENGUARD GOLD, ou seja, a norma UL com os mais rigorosos limites relativos às emissões de COV (Compostos Orgânicos Voláteis), estando, assim, em condições de garantir as melhores condições de salubridade às pessoas que vivem e habitam espaços interiores. Por conseguinte, podem ser utilizadas em ambientes como escolas e estabelecimentos de saúde, frequentados por pessoas sensíveis, como crianças e idosos.

A GREENGUARD GOLD é uma certificação amplamente reconhecida e exigida pelos programas de construção sustentável e pelos regulamentos de projeto e construção em todo o mundo, tais como o LEED (internacional) e o BREEAM (Reino Unido).

MARGRES
CERAMIC TILES

certification

certification . zertifizierung . certificação

cutting-edge technology

Each raw material used, each productive process and each technology of the complex activity of the Margres sites are studied in order to reduce the environmental impact, by saving, recycling, filtering, with the will of transforming the waste in resources and optimize the use of energy. Margres is on the cutting-edge of adopting ecologically sustainable practices and this is demonstrated by the most accurate controls, repeated on a daily basis.

spitzentechnologie

Jeder benutzte natürliche Rohstoff, jeder Herstellungsprozess und jede Technologie der komplexen Aktivität in den Industriesektoren der Margres werden studiert, um dabei die Umweltbelastung zu reduzieren, zu sparen und zu recyklieren (verwerten), mit dem Willen, den Abfall in Ressourcen umzuwandeln und den Gebrauch der erzeugten Energie zu optimieren. Margres ist an der Spitze in der Anpassung der nachhaltigen ökologischen Maßnahmen, welche durch die sorgfältigen Kontrollen, die jeden Tag durchgeführt werden, dargestellt werden.



reused non-fired material
réutilisation du tesson
wiederverwendung unbearbeiteter scherben
reutilização de caco cru



recycling of fired material
recyclage du tesson cuit
recycling von erhitzten scherben
reciclagem de caco cozido



water recycling from the production process
recyclage des eaux du processus productif
recycling von in verfahren benutztet wasser
reciclagem de água do processo



low gas emissions to atmosphere
faibles émissions de gaz dans l'atmosphère
geringe abgabe gashaltiger emissionen in die atmosphäre
baixas emissões gasosas para a atmosfera

technologie d'avant-garde

Chaque matière première, chaque processus productif et chaque technologie de la complexe activité des établissements de Margres sont étudiés de façon à limiter l'impact environnemental en épargnant, recyclant et filtrant avec la volonté de transformer les déchets en ressources et optimiser l'usage de l'énergie produite. Margres est à l'avant-garde dans l'action et les pratiques pour l'environnement comme le démontrent les contrôles les plus exigeants répétés au quotidien.

tecnologia de vanguarda

Cada matéria prima natural utilizada, cada processo produtivo e cada tecnologia da complexa atividade das unidades industriais da Margres, são estudadas de forma a minimizar o impacto ambiental, poupando, e reciclando, com a vontade de transformar desperdícios em recursos e otimizar a utilização da energia produzida. A Margres está na vanguarda na adoção de medidas ecologicamente sustentáveis as quais são demonstradas pelos mais minuciosos controlos quotidianamente efetuados.



energy saving
économie d'énergie
energieeinsparung
poupança de energia



packing from 100% recycled materials
100% de matériaux recyclables utilisés dans l'emballage
100% recycling-material wird für verpackungen benutzt
100% de materiais recicláveis utilizados na embalagem



ceramic products sustainability
durabilité des produits céramiques
nachhaltigkeit von keramikprodukten
sustentabilidade dos produtos cerâmicos



FAO pallets
FAO palettes
FAO paletten
paletes FAO

index

colour map

collections

linea collections

useful information

calibers

certification

general sales conditions

important notes

laying suggestions

magres green

outdoor extra thick

package

pr()tect

symbols

technical information

think zero

certification

certification . zertifizierung . certificação



the environment certification

Margres have obtained the most prestigious International environmental certifications. Agencies and control bodies have officially recognized the work done by the company for the safeguarding of the earth's natural resources. These certifications are proof of the high standards attained by Margres, a company which is a forerunner in terms of sustainable development. These are a clear proof of how it is possible to reconcile quality, industrial innovation and design with a serious policy for environmental safeguard.

la certification environnementale

Les établissements Margres ont obtenu de prestigieuses certifications environnementales internationales. Les entités et les organismes de contrôle ont officiellement reconnu le travail fourni par ces entreprises pour la préservation des ressources naturelles de la planète. Cette certification témoigne des bonnes pratiques environnementales de Margres, dans la protection du développement durable. C'est une démonstration concrète de l'engagement de l'entreprise en termes de Qualité, d'Innovation et de Design, le tout allié à une sérieuse politique de protection de l'environnement.

umweltzertifizierung

Die Einrichtung der Margres haben internationale Umweltzertifikate von hohem Ansehen erhalten. Überwachungsbehörden und Überwachungseinrichtungen haben offiziell die vollendeten Tätigkeiten des Unternehmens zur Wahrung der natürlichen Ressourcen des Planeten anerkannt. Diese Zertifikate bescheinigen die bewährten Umweltmethoden der Margres zum Schutz der nachhaltigen Entwicklung. Dies ist eine eindeutige Veranschaulichung der Möglichkeit, wie man Qualität, industrielle Innovation und Design mit einer ernsten Politik des Umweltschutzes abstimmen kann.

a certificação ambiental

Os estabelecimentos da Margres obtiveram certificações ambientais internacionais de grande prestígio. Entidades e organismos de controlo reconheceram oficialmente o trabalho feito pela empresa para a salvaguarda dos recursos naturais do planeta. Esta certificação testemunha as boas práticas ambientais da Margres, na salvaguarda do desenvolvimento sustentável. Esta é uma demonstração concreta de como é possível conciliar Qualidade, Inovação Industrial e Design com uma séria política de salvaguarda do ambiente.



ISO 14001
for production sites with low impact and high efficiency.



ISO 14001
produit fabriqué sans négliger l'environnement



ISO 14001
Produktion unter Einbeziehung der Umwelt

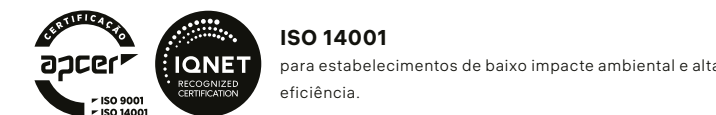

ISO 14001
para estabelecimentos de baixo impacto ambiental e alta eficiência.

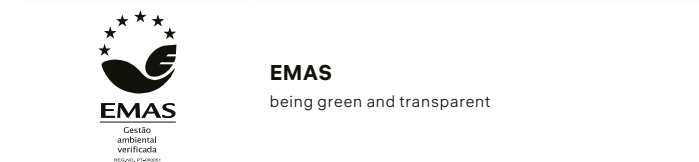

EMAS
being green and transparent



EMAS
pour être vert et transparent



EMAS
grün und transparent

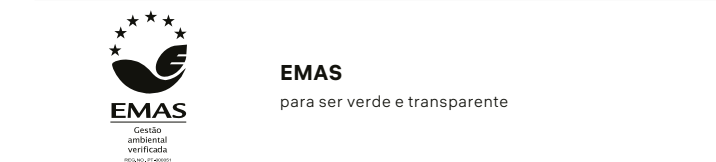

EMAS
para ser verde e transparente

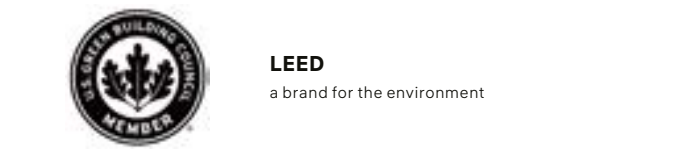

LEED
a brand for the environment



LEED
une marque pour l'environnement



LEED
eine Marke für die Umwelt

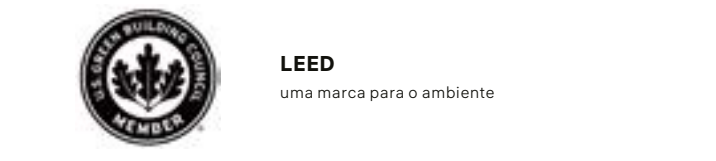

LEED
uma marca para o ambiente

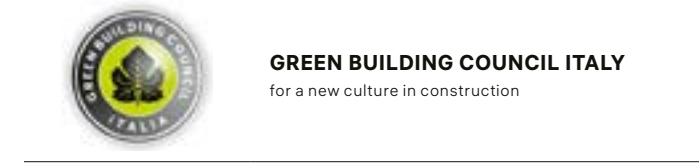

GREEN BUILDING COUNCIL ITALY
for a new culture in construction



GREEN BUILDING COUNCIL ITALY
pour une nouvelle culture de construction



GREEN BUILDING COUNCIL ITALY
für einer neues Aufbaukur



GREEN BUILDING COUNCIL ITALY
para uma nova cultura de construção

certification

certification . zertifizierung . certificação

EMAS



certification

certification . zertifizierung . certificação

APCER



IQNET



MARGRES
CERAMIC TILES

index

colour map

collections

linea collections

useful information

calibers

certification

general sales

conditions

important notes

laying suggestions

magres green

outdoor extra thick

package

pr()tect

symbols

technical information

think zero

certification

certification . zertifizierung . certificação



CSTB

Centre Scientifique et Technique du Bâtiment

The quality of the Margres porcelain ceramic tile has been certified by the main institutions in the field, namely the Centre Scientifique et Technique du Bâtiment in France, benefiting from the prestige of the QB-UPEC brand mark and for CERTIF in Portugal.

La qualité du grès cérame de Margres a obtenu le certificat des principales institutions de la spécialité notamment du Centre Scientifique et Technique du Bâtiment en France, jouissant du prestige de produit de marque QB-UPEC et par CERTIF au Portugal.

Die Qualität des Feinsteinzeugs von Margres ist von den wichtigsten Institutionen dieses Fachbereichs zertifiziert, namentlich das Centre Scientifique et Technique du Bâtiment in Frankreich, das ihm die Klassifizierung QB-UPEC verlieh, und das CERTIF in Portugal.

A qualidade do Grés Porcelânico da Margres encontra-se certificada pelas principais instituições da especialidade, nomeadamente pelo Centre Scientifique et Technique du Bâtiment França, usufruindo deste o prestígio de produto de marca QB-UPEC e pela CERTIF em Portugal.



CERTIF

certification

certification . zertifizierung . certificação



| | |
|------------|--------|
| concept | P. 139 |
| evoke | P. 105 |
| grove | P. 153 |
| hybrid | P. 93 |
| jungle | P. 117 |
| natural | P. 187 |
| prestige | P. 127 |
| pure stone | P. 69 |
| slabstone | P. 175 |
| subway | P. 191 |
| tecnica | P. 217 |
| time 2.0 | P. 201 |
| tool | P. 163 |

| |
|---|
| ■ |
| ■ |
| ■ |
| ■ |
| ■ |
| ■ |
| ■ |
| ■ |
| ■ |
| ■ |
| ■ |
| ■ |
| ■ |
| ■ |
| ■ |

| |
|---|
| ■ |
| ■ |
| ■ |
| ■ |
| ■ |
| ■ |
| ■ |
| ■ |
| ■ |
| ■ |
| ■ |
| ■ |
| ■ |
| ■ |
| ■ |

| |
|---|
| ■ |
| ■ |
| ■ |
| ■ |
| ■ |
| ■ |
| ■ |
| ■ |
| ■ |
| ■ |
| ■ |
| ■ |
| ■ |
| ■ |
| ■ |



pour plus d'informations, consultez <https://evaluation.cstb.fr>



for more information, consult <https://margres.com/en/company>
 pour plus d'informations, consultez <https://margres.com/fr/institutionnel>
 Weitere Informationen finden Sie unter <https://margres.com/de/firma>
 para mais informações, consulte <https://margres.com/pt/empresa>

index

colour map

collections

linea collections

useful information

calibers

certification

general sales

conditions

important notes

laying suggestions

magres green

outdoor extra thick

package

pr()tect

symbols

technical information

think zero

intended uses

domaines d'emploi . verwendungszwecke . utilizações previstas

The characteristics of the product and the ease of installation, both with or without adhesive (dry installation on grass, gravel, or elevated floors), make the 20MM thick porcelain tile by Margres the best solution for external flooring of public and residential areas, such as urban spaces, pavements, garden paths, car parks, terraces, swimming pool edges, bathing facilities, parks and much more.
The best solution to match external and internal spaces.

Les caractéristiques du produit ainsi que l'extrême facilité de pose aussi bien à sec (sur herbe, gravier, sols surélevés) qu'avec adhésif, font du grès cérame Margres épaisseur 20MM, la meilleure solution pour les pavages externes de zones publiques et résidentielles: places urbaines, trottoirs, voies piétonnes, parkings, terrasses, bords de piscine, établissements balnéaires, aménagement public paysager et bien d'autres domaines encore.
Une solution optimale pour obtenir un ensemble parfaitement coordonné entre intérieur et extérieur.

Die Produkteigenschaften und extreme Einfachheit sowohl der Trockenverlegung (auf Gras, Kies, als Doppelboden) als auch der Klebverlegung, machen das Feinsteinzeug von Margres mit 20MM Stärke zur besten Lösung bei Bodenbelägen im Außenbereich von öffentlichen und privaten Anlagen: Stadtplätze, Bürgersteige, Wege, Parkplätze, Terrassen, Poolumrandungen, Badeanlagen, öffentliche Grünanlagen und vieles mehr.
Die beste Lösung um eine optimale Koordination zwischen Innen- und Außenbereich zu erhalten.

As características técnicas bem como a facilidade de instalação, com ou sem colas (instalação a seco em relva, gralilha ou pavimentos sobrelevados), fazem das placas cerâmicas Margres 20MM a melhor solução para a pavimentação de espaços exteriores sejam eles públicos ou privados, tais como jardins, garagens, caminhos pedonais, terraços, piscinas, áreas urbanas, etc.
Trata-se igualmente de uma boa solução para combinar espaços interiores e exteriores.



instructions for matching sizes and pedestals in elevated floor installation

instruction pour le couplage des formats et supports lors de la pose surélevée
anweisungen für die verbindung von formaten und auflagen bei der verlegung von doppelböden
instruções de combinação de tamanhos e suportes na aplicação sobreelevada

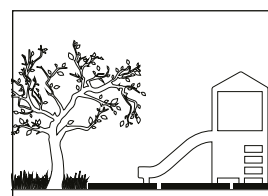
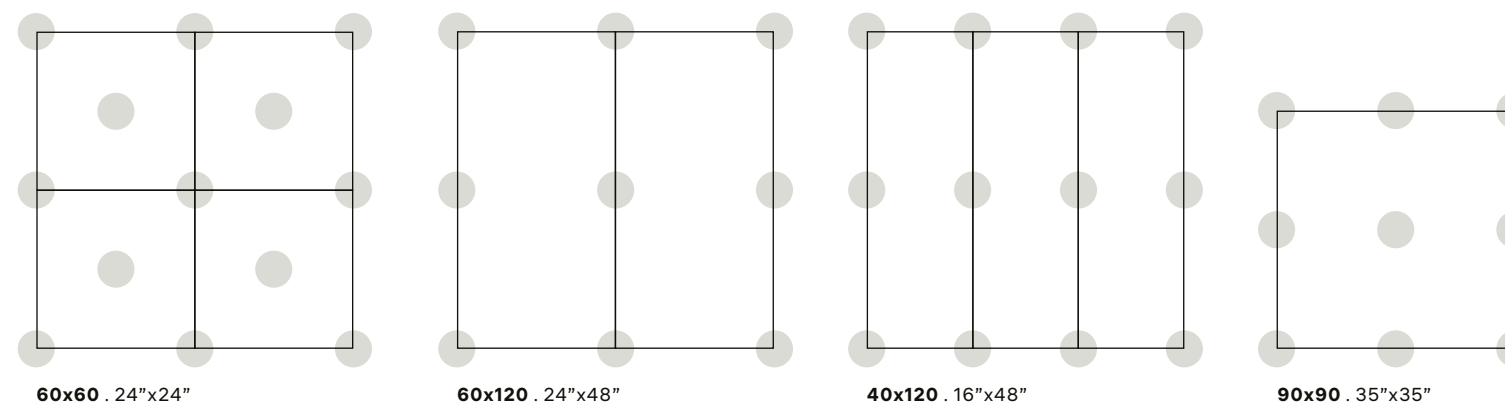

gardens and public areas
jardins et espaces publics
gärten und öffentliche anlagen
jardins e espaços públicos

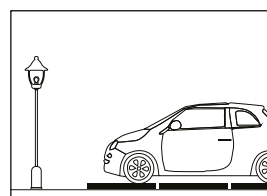

parking lots
parkings
parkplätze
parques de estacionamento

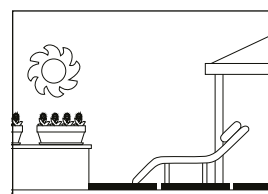

terraces
terrasses
terrassen
terraços

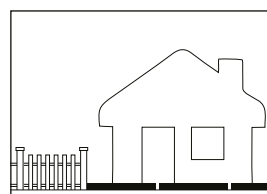

sidewalks and pedestrian areas
chaussées, zones piétonnes
bürgersteige, zugänge und andere fußgängerzonen
calçadas, acessos e zonas pedonais

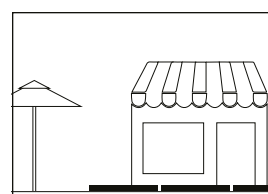

seaside resorts
complexes balnéaires
badekomplexe und seebäder
complexos e estâncias balneares

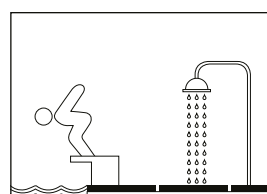

pool surrounding areas
contours de piscines
bereiche in der umgebung von schwimmbecken
envolventes de piscina

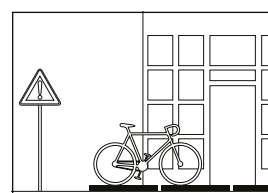

urban areas
zones urbaines
städtische gebiete
áreas urbanas

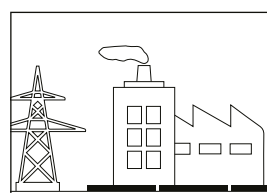

industrial areas
zones industrielles
industriegebiete
zonas industriais

special pieces

pièces spéciales . spezialteile . peças especiais

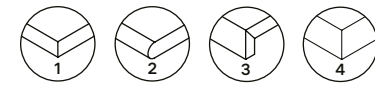

| | straight edge margelle stufenplatte base 30x60 E ASR 12"x24" | bullnose margelle arrondie stufenplatte abgerundet base boleada 30x60 E ASR 12"x24" | step extra thick 20mm nez de marche forte épaisseur 20mm massive stufenplatte 20mm degrau espessurado 20mm 30x60 E ASR 12"x24" | 30x90 E ASR 12"x36" | 30x120 E ASR 12"x48" | step extra thick 20mm corner* nez de marche forte épaisseur 20mm angle* ecke massive stufenplatte 20mm* degrau espessurado 20mm canto* 30x60 E ASR 12"x24" | 30x90 E ASR 12"x36" | 30x120 E ASR 12"x48" |
|-------------------|--|---|--|-------------------------------|--------------------------------|--|-------------------------------|--------------------------------|
| evoke | ■ MP-6490 | ■ MP-6500 | ■ MP-6590 | ■ MP-6640 | ■ MP-6685 | ■ MP-6680 | ■ MP-6700 | ■ MP-6740 |
| grove | ■ MP-6490 | ■ MP-6500 | ■ MP-6590 | | ■ MP-6685 | ■ MP-6680 | | ■ MP-6740 |
| jungle | ■ MP-6490 | ■ MP-6500 | ■ MP-6590 | | ■ MP-6685 | ■ MP-6680 | | ■ MP-6740 |
| pure stone | ■ MP-6490 | ■ MP-6500 | ■ MP-6590 | | ■ MP-6685 | ■ MP-6680 | | ■ MP-6740 |
| slabstone | ■ MP-6490 | ■ MP-6500 | ■ MP-6590 | | | ■ MP-6680 | | |
| subway | ■ MP-6490 | ■ MP-6500 | ■ MP-6590 | | | ■ MP-6680 | | |
| tool | ■ MP-6490 | ■ MP-6500 | ■ MP-6590 | | | ■ MP-6680 | | |

step extra thick 20mm
nez de marche forte épaisseur 20mm
ecke massive stufenplatte 20mm
degrau espessurado 20mm

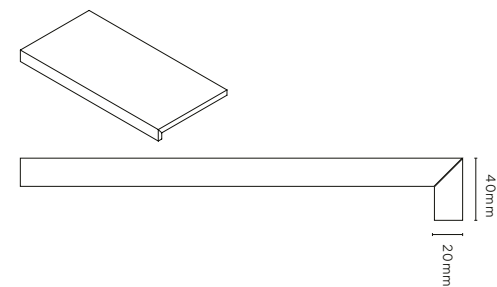

step extra thick 20mm corner
nez de marche forte épaisseur 20mm angle
ecke massive stufenplatte 20mm
degrau espessurado 20mm canto

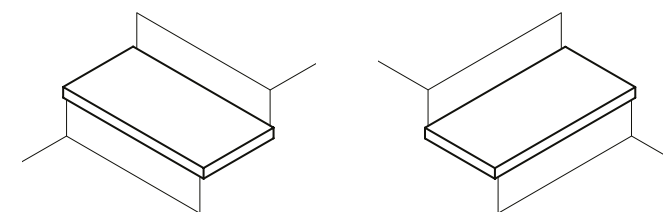

right corner . angle droit
rechten ecke . canto direito

left corner . angle gauche
links ecke . canto esquerdo

*Available in right and left corner
*Disponible dans les coin droit et gauche
*Erhältlich in der rechten Ecke und links
*Disponível no canto direito e esquerdo

swimming pool edges

margelles de piscine . beckenrandsteine . bordos de piscina

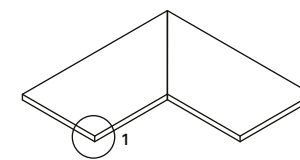
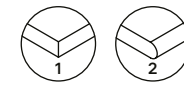

straight edge inner corner
margelle angle bord droit intérieur
eckstufe
canto interior

30x60 . 12"x24"
E ASR MP-6620

(sold per two pieces set . vendu à la paire
paarweise verkauft . vendida ao par)

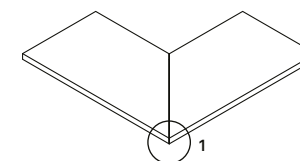

straight edge outer corner
margelle angle bord droit extérieur
eckstufe außenseite
canto exterior

30x60 . 12"x24"
E ASR MP-6620

(sold per two pieces set . vendu à la paire
paarweise verkauft . vendida ao par)

overflow grille 20MM OVER
grille 20MM
überlauf überlauf 20MM
grelha 20MM

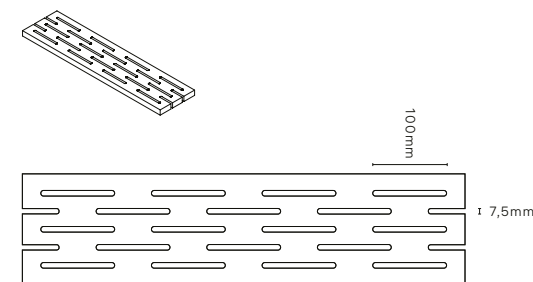

Available in all 20mm thickness ranges.
Disponible dans toutes les collections avec épaisseur 20mm.
Verfügbar in allen 20mm Stärke Serien.
Disponível em todas as coleções com espessura 20mm.

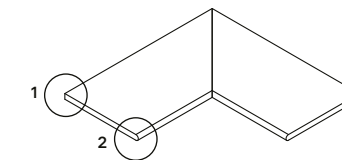

bullnose inner corner
margelle bord intérieur arrondi
abgerundete innenecke (gärung)
canto interior boleado

30x60 . 12"x24"
E ASR MP-6650

(sold per two pieces set . vendu à la paire
paarweise verkauft . vendida ao par)

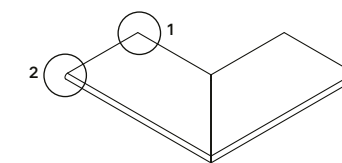

bullnose outer corner
margelle bord extérieur arrondi
abgerundete aussenecke (gärung)
canto exterior boleado

30x60 . 12"x24"
E ASR MP-6650

(sold per two pieces set . vendu à la paire
paarweise verkauft . vendida ao par)

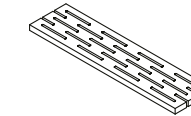

overflow grille MG
grille MG
überlauf MG
grelha MG
15x60 . 6"x24"
E ASR MP-6520

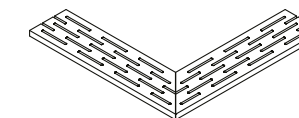

overflow corner grille MG
angle grille MG
überlauf ecke MG
canto grelha MG
15x60 . 6"x24"
E ASR MP-6700

(sold per two pieces set . vendu à la paire
paarweise verkauft . vendida ao par)

useful information

calibers

certification

general sales
conditions

important notes

laying suggestions

magres green

outdoor extra thick

package

pr()tect

symbols

technical information

think zero

technical information

— information technique . technische information . informação técnica

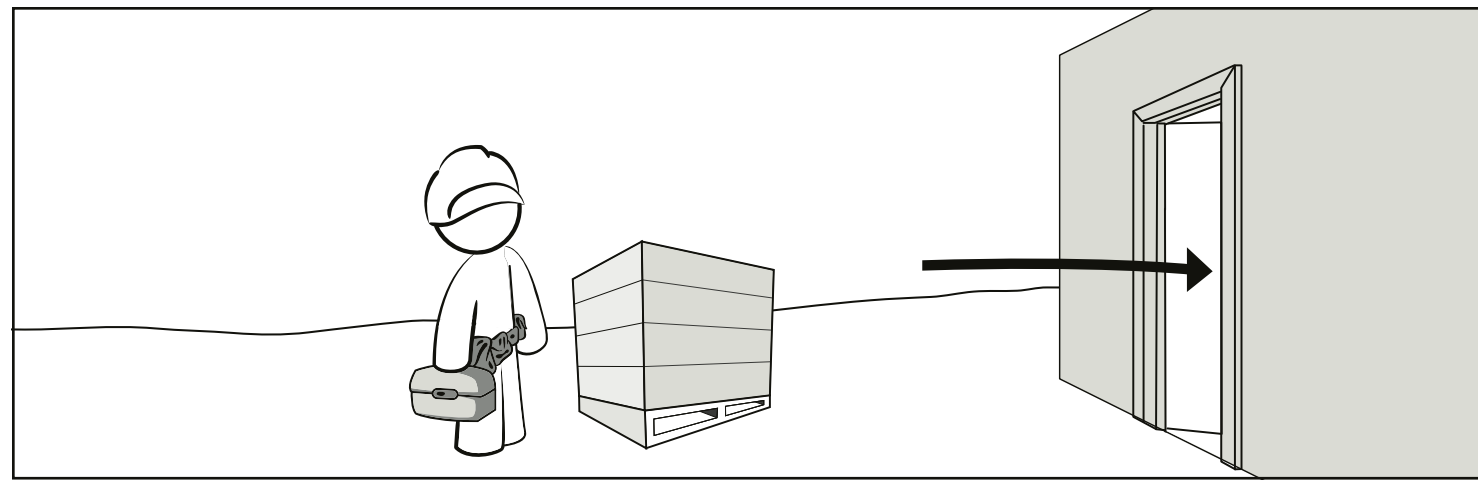

Before (beginning the) laying (of) ceramic material, you should take the following aspects into account:

- Check if the ceramic material is suitable for (use at) the selected site, according to its specifications and technical characteristics;
- Check whether there is enough material to conclude the work;
- Check the boxes to see/confirm in the boxes if the product is in the same shade, choice and caliber;
- Claims regarding these items cannot be accepted after tile setting.

The good performance of the ceramic material depends strongly on the conditions of application for which it is extremely important to ensure the following assumptions:

Avant de commencer la pose du matériau céramique, les aspects suivants devront être pris en considération:

- Vérifier si le matériau céramique est indiqué pour une utilisation dans le lieu choisi, conformément à ses spécifications et caractéristiques techniques;
- Vérifier s'il existe la quantité de matériau suffisante pour réaliser le chantier;
- Confirmer dans les boîtes si le produit est du même ton, de la même qualité, et du même calibre;
- Les réclamations relatives au matériel déjà posé ne pourront pas être acceptées.

La bonne performance du matériau céramique dépend fortement des conditions d'application. Il est donc extrêmement important de garantir les conditions préalables suivantes:

Vor dem Beginn der Verlegearbeiten sollten Sie folgende Punkte berücksichtigen:

- Bitte überprüfen Sie, ob die gewählte Fliese laut ihrer Oberflächenbeschaffenheit und ihren technischen Eigenschaften geeignet für das Einsatzgebiet ist;
- Bitte prüfen Sie nach, ob die Menge der gewählten Fliese ausreicht, um das geplante Bauprojekt fertig zu stellen;
- Bitte prüfen Sie, ob die Fliesen aus verschiedenen Kartons dieselbe Beschaffenheit, (Ton, Wahl und Kaliber) haben;
- Diesbezügliche Beanstandungen können nach der Verlegung nicht berücksichtigt werden.

Die Leistungsfähigkeit der Fliese hängt stark davon ab, wie die Fliesen verlegt werden. Daher ist es sehr wichtig, die folgenden Punkte zu beachten:

Antes de iniciar o assentamento do material cerâmico, deverá ter em consideração os seguintes aspetos:

- Verificar se o material cerâmico é indicado para utilizar no local selecionado de acordo com as suas especificações e características técnicas;
- Verificar se existe material suficiente para realizar a obra;
- Confirmar nas caixas se o produto é da mesma tonalidade/lote, escolha e calibre;
- Não se aceitam reclamações relativas a materiais já aplicados.

O bom desempenho do material cerâmico depende fortemente das condições de aplicação pelo que é de extrema importância garantir os seguintes pressupostos:

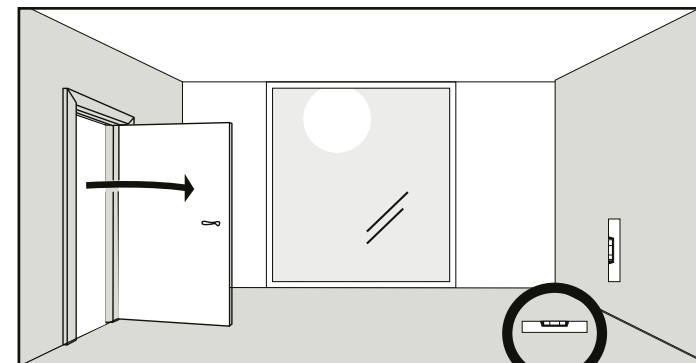

01

support

The support must be stable, free of debris, dust and cracks. Curing times and stability of the treatments to which the support may have been subjected should be respected.

You should check its flatness and stabilize it, if necessary with the help of products suitable for the purpose.

These aspects are vital for wall and floor ceramic tiles.

le support

Le support doit être stable, exempt de résidus, fentes et poussières. Les temps de durcissement et de stabilité des traitements auxquels il doit être soumis devront être respectés.

La planéité du support doit être vérifiée et le nivellement doit être réalisé si cela est nécessaire, à l'aide de produits appropriés.

Ces aspects sont essentiels pour les revêtements de sol et muraux céramiques.

der untergrund

Der Untergrund muss stabil, sauber, sowie frei von Rissen und Staub sein. Sollte der Untergrund vor dem Verlegen der Fliesen speziell behandelt werden müssen, so sollten Sie darauf achten, dass die Behandlung gut gelungen und abgeschlossen ist, bevor Sie die Fliesen verlegen.

Sie sollten den Untergrund inspizieren. Falls er nicht eben ist, muss er mit Hilfe von passenden Produkten grundiert werden.

Diese Vorsicht ist angebracht und eine unabdingbare Voraussetzung für das fachgerechte Verlegen von Boden- und Wandfliesen.

o suporte

O suporte deve apresentar-se estável, limpo de resíduos, fendas e poeiras. Deverão ser respeitados os tempos de cura e estabilidade dos tratamentos a que possa ter sido sujeito.

Deve fazer-se a verificação da planaridade do mesmo, procedendo à regularização, se necessário com a ajuda de produtos adequados a esse fim.

Estes aspetos são vitais para pavimentos e revestimentos cerâmicos.

technical information

information technique . technische information . informação técnica

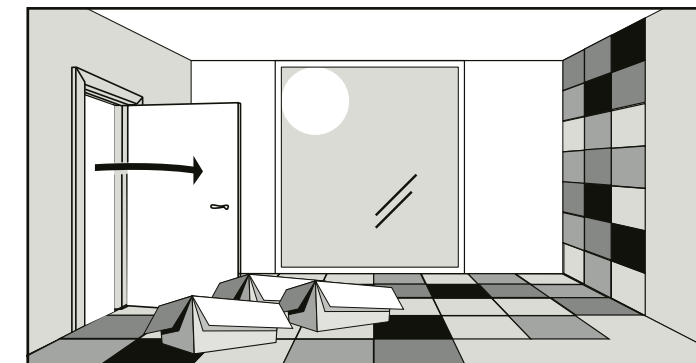

02

material

For a better visual effect of the product, it is advisable to use alternating ceramic pieces taken from various packages simultaneously.

If the product has shade variations or has different graphics and shades, it should be applied randomly.

le matériau

Pour obtenir un meilleur effet visuel avec le produit, il est conseillé d'utiliser de forme alternée des pièces céramiques retirées simultanément de plusieurs emballages.

Si le produit est dénuancé ou a un aspect graphique différent et une tonalité différente, il devra être appliqué de forme aléatoire.

das material

Damit Sie das beste Ergebnis erzielen, ist es ratsam, die Fliesen immer aus verschiedenen Paketen zu wählen und in regelmäßig abwechselnder Folge zu verlegen.

Falls das Produkt diverse Farbschattierung, einen unterschiedliche Farbton oder grafisches Design aufweist, müssen die Fliesen auf diese Weise verlegt werden.

o material

Para obter um melhor efeito visual do produto, aconselha-se a utilização, alternada, de peças cerâmicas retiradas de várias embalagens em simultâneo.

Caso o produto seja destonalizado ou tenha gráfica e tonalidade diferente, deverá ser aplicado de forma aleatória.

index

colour map

collections

linea collections

useful information

calibers

certification

general sales conditions

important notes

laying suggestions

magres green

outdoor extra thick

package

pr()tect

symbols

technical information

think zero

technical information

information technique . technische information . informação técnica

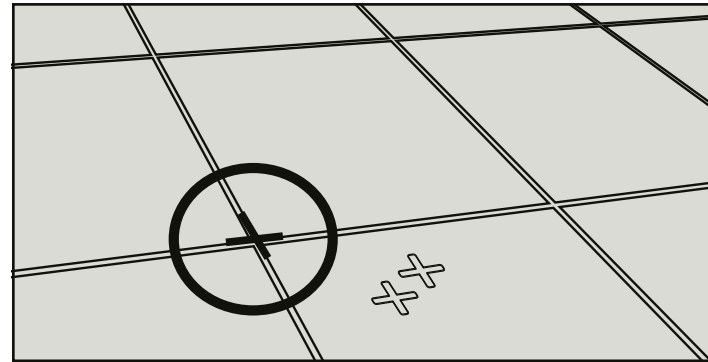

≥ 2mm ≥ 3mm

03

joins for tile-laying

For a perfect application of the ceramic pieces, you should definitely use joints. They fulfill important aesthetic and technical functions, facilitating alignment of the materials, absorbing any possible deformation liable to be felt in the structure - floor and wall - thus preventing the transmission of deformations to the ceramic pieces.

We advise the use of leveling systems when applying big ceramic formats material.

Use the minimum recommended joints so as to ensure a good aesthetic aspect of the ceramic pieces, and respect the rules of application as follows.

NOTE: Regardless of the values presented here, the person applying it should always follow the regulations of the countries where he is doing this application work.

joins de pose

L'utilisation de joints de pose est obligatoire afin d'obtenir une pose parfaite des pièces céramiques,. Ils remplissent une importante fonction esthétique et technique. Ils facilitent l'alignement des matériaux et absorbent d'éventuelles déformations qui peuvent se produire dans la structure – sols et murs – et empêchent donc la transmission de ces déformations aux pièces céramiques. Nous recommandons l'utilisation de niveleurs lors de l'application de matériaux de grand format

Utiliser Les joints minimaux recommandés afin de garantir un bon aspect esthétique des pièces céramiques et respecter les normes d'application sont les suivants.

REMARQUE: Indépendamment des valeurs ici présentées, l'applicateur devra toujours suivre les réglementations du pays où il réalise ce travail d'application.

das verfugen

Um die keramischen Platten perfekt zu verlegen, sollten Sie die Wand oder den Boden ordnungsgemäß verfugen. Die Fugen haben wichtige ästhetische und technische Funktionen. Sie erleichtern das Aufreihen der Fliesen; sie absorbieren eventuelle Verformungen der Wand oder des Bodens, und vermeiden dadurch die Übertragung dieser Verformungen auf die Fliesen.

Wir empfehlen die Benutzung von selbstnivellierenden Abstandhaltern, wenn es darum geht, Fliesen von grösseren Formaten zu verlegen, wie zum Beispiel Die empfohlenen Fugenbreiten, welche eine schöne Optik sowie eine regelgerechte Verlegung gewährleisten, sind nachfolgend angegeben.

WICHTIG: Abgesehen von den oben angegebenen Fugenbreiten, muss der Fliesenleger immer den jeweils geltenden landesspezifischen Vorschriften Folge leisten.

juntas de assentamento

Tendo em vista uma perfeita aplicação das peças cerâmicas, deve usar-se obrigatoriamente juntas de assentamento. Estas cumprem importantes funções estéticas e técnicas, facilitando o alinhamento dos materiais, absorvendo eventuais deformações que se possam fazer sentir na estrutura – chão e parede – e impedindo, assim, a transmissão destas deformações às peças cerâmicas.

Aconselhamos a utilização de niveladores aquando da aplicação de material de grandes formatos.

Utilizar as juntas mínimas recomendadas de forma a garantir um bom aspeto estético das peças cerâmicas, bem como respeitar as normas de aplicação.

NOTA: independentemente dos valores aqui apresentados, o aplicador deverá sempre seguir as normativas dos países onde está a fazer este trabalho de aplicação.

| | application . pose . anwendung . aplicação | | |
|---|--|---|--|
| finishing finition fertigung acabamento | indoor intérieur innen interior | outdoor extérieur außen exterior | raised floor dalles sur plot doppelboden sobreelevado |
| non rectifié non rectifié presskante não retificado | 3mm | 4mm * | - |
| rectified rectifié rektifiziert retificado | 2mm | 3mm * | - |
| 20mm rectified 20mm rectifié 20mm rektifiziert 20mm retificado | 2mm | 3mm * | 3mm |

* it's recommended to increase in 2mm the minimum joint in the darker colours. For further information please go to our website and read product's technical data sheet.

* pour les couleurs foncées il est recommandé de rajouter 2mm au joint minimum. Consultez la fiche technique du produit respectif sur le site web.

* Bei dunklen Farben wird empfohlen, 2 mm zur Mindestfuge noch weiter hinzuzufügen. Konsultieren Sie das technische Datenblatt des Produkts auf der Website.

* para as cores escuras recomenda-se acrescentar 2mm à junta mínima. Consultar a ficha técnica do respetivo produto no site.

MARGRES
CERAMIC TILES

technical information

information technique . technische information . informação técnica

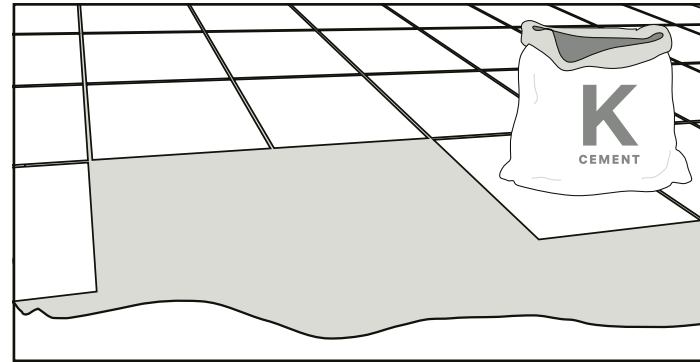

04

glue and mortar

The mortars, grouting mortars, glue-cements, and glues to be used should take into account both the support and the intended purpose of the ceramic pieces - indoor, outdoor, wall, floor - and their typology – Porcelain stoneware.

You should follow the instructions provided by the manufacturer on its use.

colle et mortiers

Les mortiers, mortiers de rejointoiment, ciments-colles et colles à utiliser devront tenir compte du support et de la fin à laquelle sont destinées les pièces céramiques - intérieur, extérieur, mur, plancher - ainsi que de leur typologie - Grès cérame.

Vous devrez suivre les instructions indiquées par le fabricant pour son utilisation.

kleber und mörtel

Welchen Mörtel, welchen Zementkleber oder welche andere Verbundmittel Sie am besten verwenden, hängt sowohl vom Untergrund als auch vom Material (Monoporosa, glasierte Fliesen) ab. Es kommt ebenso darauf an, ob die Fliesen im Außen- Feinsteinzeug.

Bitte befolgen Sie die Herstellerangaben zum Gebrauch des Produktes.

cola e argamassas

As argamassas, argamassas de rejuntamento, cimentos-colas e colas a utilizar deverão ter em conta o suporte e o fim a que se destinam as peças cerâmicas - interior, exterior, parede, pavimento - e a sua tipologia - Grés porcelânico.

Deverá seguir as instruções indicadas pelo fabricante sobre a sua utilização.

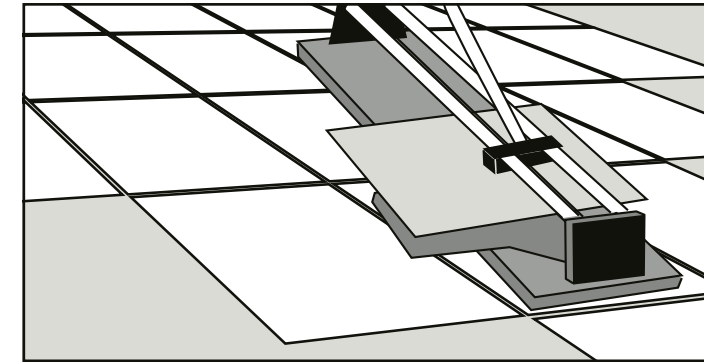

05

cutting instructions

We recommend wet cutting or the score and snap method during the installation process.

Do not dry cut using power tools during the installation process.

Improper installation techniques could expose installer to harmful silica dust.

instructions de découpe

Nous recommandons la découpe avec refroidissement d'eau ou usage d'un découpant manuel avec méthode de marquage et decoupage pendant la pose.

Ne pas utiliser d'outils électriques ou de decoupage à sec pendant la pose.

Des techniques de pose inadéquates pourront exposer le poseur à des poussières de silice et nuire à la santé.

schneideempfehlung

Wir empfehlen das Nassschneiden oder die Ritz- und Brechmethode während des Installationsprozesses.

Während des Installationsvorgangs nicht mit Elektrowerkzeugen trocken schneiden.

Durch unsachgemäße Installationstechniken kann der Installateur schädlichem Quarzstaub ausgesetzt werden.

instruções de corte

Recomendamos o corte com arrefecimento de água ou utilização de cortador manual com método de marcação e corte durante o processo de instalação.

Não usar ferramentas elétricas com corte a seco durante o processo de instalação.

Técnicas de instalação impróprias poderão expor o instalador à poeira de sílica de forma prejudicial.

index

colour map

collections

linea collections

useful information

calibers

certification

general sales
conditions

important notes

laying suggestions

magres green

outdoor extra thick

package

pr()tect

symbols

technical information

think zero

technical information

— information technique . technische information . informação técnica

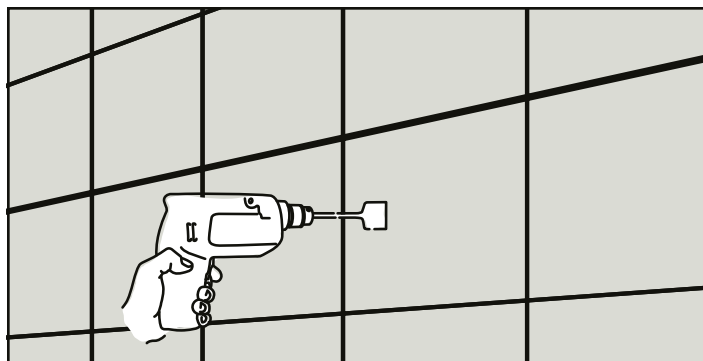

06

holes

For drilling you should use diamond twist drills with a diameter adaptable to the desired hole.

perçages

Pour le perçage, utiliser des trépan diamantés avec un diamètre adapté au trou désiré.

löcher

Löcher sollten im gewünschten Durchmesser mittels einer Diamanthammerbohrkrone in die Fliese gebohrt werden.

furos

Na furação deverão ser utilizadas brocas cranianas diamantadas com diâmetro adaptável ao furo pretendido.

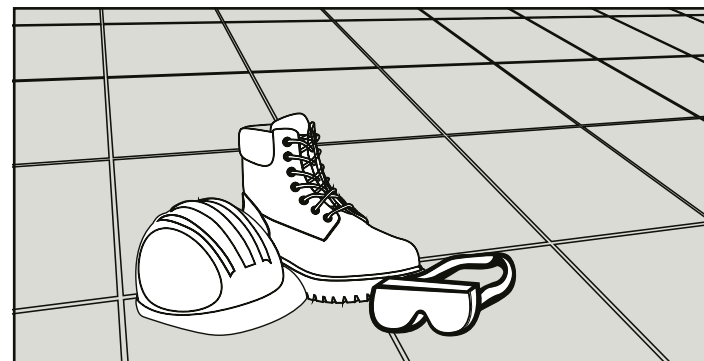

07

safety and preparation for laying the material

We advise the use of appropriate PPE (personal protective equipment), namely safety footwear, protective gloves and even goggles (safety glasses) and hearing protection in operations of cutting material.

Good practices must be followed in terms of lifting and carrying loads.

sécurité lors de la préparation et de la pose du matériau

Il est conseillé d'utiliser un EPI (équipement de protection individuelle) approprié, notamment des chaussures de sécurité, des gants de protection, mais aussi des lunettes et une protection auditive lors des opérations de coupe du matériau.

Respectez les bonnes pratiques concernant le levage et le transport manuel de charges devront être appliquées.

sicherheitshinweise für das verlegen von fliesen

Wir empfehlen Ihnen, immer die passende Schutzkleidung zu tragen. Wir ermahnen Sie eindringlich, Schutzschuhe, -handschuhe, -brille sowie Gehörschutz zu benutzen, wenn Sie die Fliesen zuschneiden.

Achten Sie bitte auf die richtige Körperhaltung, wenn Sie Lasten heben und tragen.

segurança na preparação e assentamento do material

Aconselha-se a utilização de EPI (equipamento de proteção individual) adequado, nomeadamente, calçado de segurança, luvas de proteção e ainda óculos e proteção auditiva nas operações de corte do material.

Devem ser cumpridas as boas práticas a nível do levantamento e transporte manual de cargas.

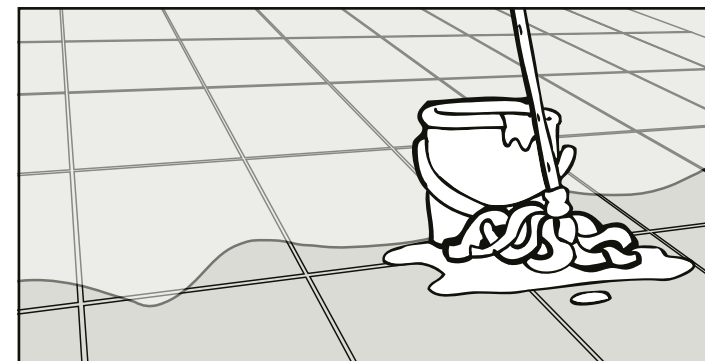

08

protection and cleaning

All residues of glue and grout mortar should be cleaned from the surface of the parts immediately after application and in accordance with the manufacturer's instructions.

Immediately after the laying of ceramic material it is recommended that the ceramic parts are / will be duly protected. For dirt removal after the work, such as left-over joints, cements, etc., it is recommended that you use a buffered descaling acid to remove all residues.

In daily maintenance, ordinary detergents may be used, respecting the dilutions recommended by the respective manufacturer.

Regarding decorated pieces, you should avoid the use of abrasive cleansers that may damage the pieces.

Pieces decorated through the depositing of titanium particles - Gold, Silver and Copper - which give them a metallic aspect should be handled with care. The final cleaning and maintenance of this type of product should be made with detergents suitable for metals - stainless steel brightener - so as to create an antistatic effect that can repel dirt and protect the product from fats and corrosion.

Regular cleaning of the product should be done with a damp cloth moisturized with water or window cleaner, and after it gets dry, a dry cloth shall be used.

protection et nettoyage

Tous les résidus de colle et de mortier de jointoiment doivent être nettoyés de la surface des pièces immédiatement après l'application et conformément aux instructions du fabricant.

Immédiatement après la pose du matériau céramique, il est recommandé de protéger correctement les pièces céramiques. Pour l'élimination de la saleté résultant des travaux, comme les résidus de joints, ciments, etc., il est recommandé d'utiliser un acide tamponné désincrustant.

L'entretien quotidien pourra être réalisé avec des détergents ordinaires, en respectant les dilutions recommandées par le fabricant respectif.

Pour les pièces décorées, l'utilisation de produits de nettoyage abrasifs devra être évitée car ils pourront endommager les pièces.

Les pièces décorées grâce au dépôt de particules de titane - Gold, Silver et Copper - qui lui confèrent un aspect métallique, devront être manipulées avec soin. Le nettoyage final et d'entretien de ce type de produit devra être réalisé avec des détergents spécifiques pour les métaux - agent de brillantage d'acier inox - afin de créer un effet antistatique qui puisse repousser la saleté et protéger le produit des graisses et de la corrosion.

Le nettoyage régulier du produit doit être effectué avec un chiffon imbibé d'eau ou de nettoyant pour vitres et, après séchage, on doit passer un chiffon sec.

technical information

information technique . technische information . informação técnica

schutz und reinigung

Alle Rückstände von Klebstoff und Fugenmörtel sollten von der Oberfläche der Stücke unmittelbar nach dem Auftragen und in Übereinstimmung mit den Anweisungen des Herstellers gereinigt werden.

Bitte vergessen Sie nicht sofort nach Beendigung der Verlegearbeiten, die verflieste Fläche ordnungsgemäß zu schützen. Waschen Sie die verflieste Fläche mit Säure um etwaigen Schmutz (wie z.B.: Schlieren vom Fugenmaterial, Zement, etc.) zu beseitigen.

Für die alltägliche Pflege empfehlen wir die Verwendung von handelsüblichen Reinigungsmitteln. Beachten Sie bitte die Verdünnungsanweisung des Herstellers des Produktes.

Die Pflege und die Reinigung der keramischen Platten ist sehr einfach und sollte mit neutralen Putzmitteln durchgeführt werden.

Bitte befolgen Sie die Herstellerangaben zum Gebrauch des Produktes.

Schleifmittel können zur Beschädigung der Dekore führen und sind daher zu vermeiden.

Gold, Silver und Copper Stücke die durch die Ablagerung von Titanpartikeln - die ihnen einen metallischen Aspekt geben, verziert sind, sollten mit Vorsicht behandelt werden. Die Endreinigung und Wartung dieses Produkttyps sollte mit für Metalle geeigneten Reinigungsmitteln - Aufheller aus rostfreiem Stahl - durchgeführt werden, um eine antistatische Wirkung zu erzielen, die Schmutz abweisen und das Produkt vor Fetten und Korrosion schützen kann.

Die regelmäßige Reinigung des Produkts sollte mit einem mit Wasser oder Glasreiniger angefeuchteten Tuch erfolgen. Nach dem Trocknen sollte man die Flächen mit einem trockenen Tuch abwischen.

proteção e limpeza

Todos os resíduos de cola e argamassa de rejuntamento devem ser limpos da superfície das peças, imediatamente após a sua aplicação e de acordo com as instruções do fabricante.

Imediatamente após o assentamento do material cerâmico recomenda-se que as peças cerâmicas sejam devidamente protegidas. Para remoção de sujidade pós-obra, tais como resto de junta, cimentos, etc, recomenda-se a utilização de um ácido desincrustante tamponado para remoção de todos os resíduos.

Na manutenção diária poderão ser utilizados detergentes comuns, respeitando as diluições recomendadas pelo respetivo fabricante.

Relativamente às peças decoradas, dever-se-á evitar a utilização de produtos de limpeza abrasivos, que poderão danificar as peças.

As peças decoradas através da deposição de partículas de titânio - acabamento Gold, Silver e Copper - que lhe conferem um aspeto metálico deverão ser manuseadas com cuidado. A limpeza final e de manutenção deste tipo de produto deverá ser feita com detergentes próprios para metais - abrilhantador de aço inox - de forma a criar um efeito antiestático que possa repelir a sujidade e proteger o produto de gorduras e corrosão.

A limpeza regular do produto deverá ser feita com um pano humedecido em água ou limpa-vidros e após secagem deverá ser passado um pano seco.

index

colour map

collections

linea collections

useful information

calibers

certification

general sales conditions

important notes

laying suggestions

magres green

outdoor extra thick

package

pr()tect

symbols

technical information

think zero

technical information

information technique . technische information . informação técnica

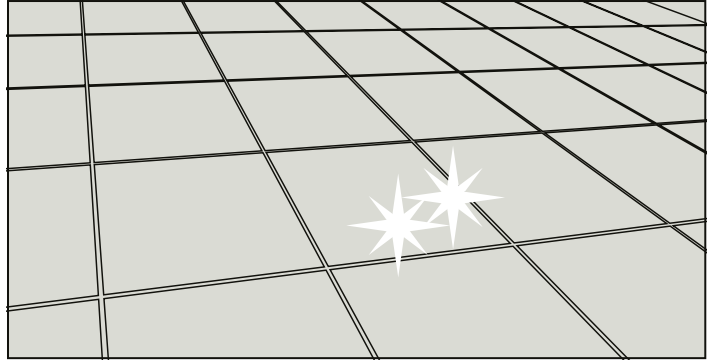

09

polished and soft shiny products

The parts of POLISHED and SOFT SHINY finishes series require specialized application and maintenance treatment.

The POLISHED and SOFT SHINY finishes are recommended, as well as for wall cladding, also for flooring in residential or light commercial areas that are not subjected to heavy traffic, where anti-slip characteristics are not required. The occasional presence of small inconsistencies or little spots on the surface is to be considered a characteristic of the material and of its unique production process. If the product is laid in direct contact with external environments, it is recommended to use protective solutions to reduce the formation of scratches.

Glue and Mortar

Preferably use mortars for grouting of color identical to the color of the product, and according to its specification - stoneware.

Application

In its application, you should take utmost care in removing the mortars used for grouting. Cleaning must be carried out with a wet cloth or sponge while the joint mortars are still wet, and avoid the use of abrasive detergents that could damage the parts.

Protection and Cleaning

The final cleaning and maintenance of the product should be done with suitable detergents for floorings.

Diluted highly concentrated detergent should be used in accordance with the supplier's instructions and, depending on the degree of dirt, dilution of the detergent may be greatly reduced and in some cases may reach the proportion of 1/3 (detergent / water).

Scrub with a micro-fiber cleaning cloth.

If the product is heavily soiled, we advise you to clean it manually.

In very exceptional cases of non-removal of dirt with the above presented method, we recommend the use of a white polymer foam (1) used only with water.

(1) Commercially known as magic sponge.

produits polis et adoucis

Les pièces des séries à finition POLI et ADOUCI nécessitent un traitement d'application et d'entretien spécialisé.

En plus des revêtements, la finition POLI et ADOUCI est également recommandée pour les sols dans les environnements résidentiels ou commerciaux légers peu soumis à des contraintes élevées, pour lesquels aucune prestation antidérapante n'est requise. La présence sporadique de petites irrégularités ou de points à la surface doit être considérée comme une caractéristique du matériau et de sa fabrication particulière. Si le produit est placé en contact direct avec l'extérieur, il est conseillé d'utiliser des solutions de protection afin d'éviter la formation de

rayures. Dans les zones à passage de charges lourdes concentrées, l'utilisation de produits d'épaisseur réduite n'est pas recommandée.

Colle et mortier

Utilisez des mortiers pour le jointoiment, de préférence de couleur identique à celle du produit, et selon les spécifications du produit - grès.

Application

Lors de l'application, vous devez faire très attention à l'enlèvement des mortiers utilisés pour le jointement. Le nettoyage doit être effectué avec un chiffon humide ou une éponge, alors que les mortiers des joints sont encore humides, et on doit éviter l'utilisation de détergents abrasifs qui pourraient endommager les pièces.

Protection et nettoyage

Le nettoyage final et l'entretien du produit doivent être effectués avec des détergents appropriés pour les revêtements de sol.

On doit utiliser un détergent hautement concentré, dilué conformément aux instructions du fournisseur. En fonction du degré de salissure, la dilution du détergent pourra être peut être considérablement réduite et dans certains cas, elle peut atteindre la proportion de 1/3 (détergent/eau).

Frotter avec un chiffon de nettoyage en microfibre.

Si le produit est très sale, nous vous conseillons de le nettoyer à la main.

Dans les cas très exceptionnels de non-élimination de la saleté avec la méthode présentée ci-dessus, nous recommandons l'utilisation d'une mousse polymère blanche (1) utilisée uniquement avec de l'eau.

(1) Commercialement appelée éponge magique.

polierte und halbpoliert produkte

Die Serien Reihen mit POLIERTER und HALB POLIERTER Fertigstellung erfordern eine spezielle Anwendung und Wartung.

Die POLIERTEN und HALBPOLIERTEN Oberflächen werden nicht nur für Wandverkleidungen empfohlen, sondern auch für Böden in Wohn- bzw. Gewerbebereichen, die keiner hohen Belastung ausgesetzt sind und bei denen keine rutschhemmende Wirkung erforderlich ist. Das sporadische Vorhandensein von kleinen Unebenheiten oder Punkten auf der Oberfläche ist als ein Merkmal von Material und besonderer Verarbeitung zu betrachten. Wird das Produkt in direkten Kontakt mit der Außenseite gebracht, wird empfohlen, Schutzlösungen zu verwenden, um die Bildung von Kratzern zu vermeiden. In Bereichen, die schwerer Belastung ausgesetzt sind, ist die Verwendung von Produkten mit reduzierter Stärke nicht empfehlenswert.

Klebstoff und Mörtel

Verwenden Sie Betumenmasse, vorzugsweise mit einer Farbe, die mit der Farbe des Produkts identisch ist, und gemäß der Produktspezifikation - Steinzeug.

Anwendung und erste Reinigung

Sie sollten beim Entfernen des zur Ausfugung verwendeten Mörtels vorsichtig vorgehen. Die Reinigung sollte durchgeführt werden, solange der Fugenmörtel noch feucht ist. Verwenden Sie dazu ein feuchtes Tuch oder einen Schwamm und vermeiden Sie kratzenden oder scheuernden Mittel, die die Teile beschädigen könnten.

Wenn die Teile einen trockenen Überschuss an Abdichtung aufweisen, entfernen Sie sie am besten mit einem sauberen, trockenen Papiertuch oder einem Stofftuch. Diese Reinigung kann entweder manuell oder mit einem geeigneten Spatel erfolgen.

Wir empfehlen, bei dieser Reinigung keine Schleifmittel oder kontaminierenden Materialien zu verwenden.

Wenn für die Reinigung flüssige Produkte verwendet werden, kann dies dazu führen, dass die gewünschte Wirksamkeit der abweisenden und schützenden Behandlung mit der wasserfesten Anwendung verringert wird.

Wartung

Die finale Reinigung und Pflege des Produkts muss mit für Fußböden geeigneten Reinigungsmitteln erfolgen.

Es sollte ein hochkonzentriertes Reinigungsmittel verwendet werden, das gemäß den Anweisungen des Lieferanten verdünnt werden soll. Je nach Verschmutzungsgrad muss die Verdünnung des Waschmittels möglicherweise erheblich reduziert werden, in einigen Fällen mit einem Anteil von 1/3 (Reinigungsmittel / Wasser).

Mit einem Mikrofaser-Reinigungstuch einreiben.

Wenn das Produkt sehr schmutzig ist, empfehlen wir, es manuell zu reinigen.

In Ausnahmefällen, in denen mit der oben beschriebenen Methode der Schmutz nicht entfernt werden kann, empfehlen wir die Verwendung eines weißen Polymerschaums (1), der nur mit Wasser verwendet wird.

(1) Im Handel als magischer Schwamm bekannt.

produtos polidos e amaciados

As peças das séries de acabamento polido e amaciado exigem um tratamento de aplicação e de manutenção especializadas.

O acabamento POLIDO e AMACIADO, para além de ser aconselhado para revestimentos, é também indicado para pavimentos de ambientes residenciais ou comerciais de tráfego ligeiro, não sujeitos a elevada utilização, ou onde não sejam requeridas quaisquer prestações antiderrapantes. A presença esporádica de pequenas não uniformidades ou pontos na superfície deve ser considerada uma característica do material e do seu particular acabamento. Se o produto for colocado em contato direto com o exterior, recomenda-se o uso de soluções protetoras de modo a reduzir a possibilidade de formação de riscos. É da responsabilidade do instalador providenciar sempre a proteção das peças cerâmicas acabadas e limpas, antes da entrega ao cliente, utilizando materiais de proteção adequados (por ex. painéis de aglomerado, folhas de cartão, etc.).

Cola e Argamassa

Utilizar argamassas para betumação, de preferência de cor idêntica à cor do produto, e de acordo com a especificação do produto - grés.

Aplicação e primeira limpeza

Na sua aplicação deverá ter o máximo cuidado na remoção das argamassas utilizadas para rejuntar. A limpeza deve ser efetuada, enquanto as argamassas da junta ainda estiverem húmidas, com um pano ou esponja molhada, devendo-se evitar a utilização de detergentes abrasivos que poderão danificar as peças.

Caso as peças apresentem excesso seco de impermeabilizante, a melhor forma de o remover é, esfregando com papel ou pano limpo e seco, podendo essa limpeza ser realizada manualmente ou usando uma monoespátula apropriada. Aconselhamos que esta limpeza seja realizada sem nenhum tipo de materiais abrasivos ou contaminantes.

Uma eventual limpeza com produtos líquidos pode ser potenciadora na diminuição da eficácia do tratamento repelente e protetivo pretendido com a aplicação impermeabilizante.

Manutenção

A limpeza final e de manutenção do produto deverá ser feito com detergentes próprios para pavimento.

Deverá ser usado detergente de alta concentração diluído conforme a indicação do fornecedor, e dependendo do grau de sujidade, a diluição do detergente poderá ter de ser bastante reduzida, podendo em alguns casos chegar à proporção de 1/3 (detergente/água).

Esfregar com um pano de limpeza de micro-fibra.

No caso de o produto apresentar muita sujidade, aconselhamos a que a limpeza seja feita manualmente.

Em casos muito excecionais da não remoção da sujidade com o método apresentado acima, recomendamos o uso de uma espuma polimérica branca (1) usada apenas com água.

(1) Comercialmente conhecida como esponja mágica.

technical information

information technique . technische information . informação técnica

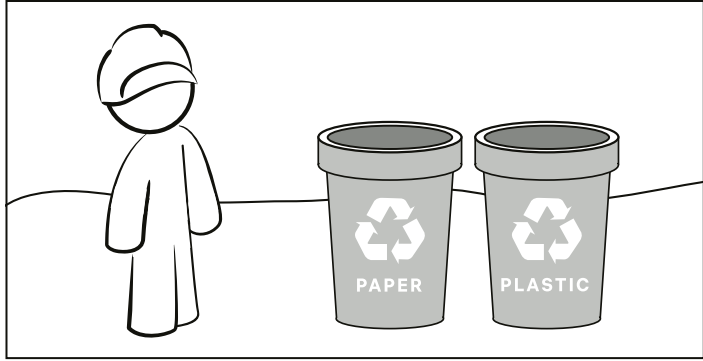

10

life cycle

The environmental impacts of our products are distributed through their life cycle complying extraction, raw materials transport, production, distribution, use and end of life.

Margres minimize these impacts through good practices of environmental management.

At the end of the product 's life cycle, Margres asks for your best management, favoring the reuse or recycling in a perspective of a circular economy.

cycle de vie

Les impacts environnementaux de nos produits sont distribués tout au long de leur cycle de vie, dans les phases d'extraction, de transport des matières premières, de production, de distribution, d'utilisation et de fin de vie. Chez Margres on minimise ces impacts environnementaux grâce aux bonnes pratiques de gestion de l'environnement.

Dans l'utilisation et la fin de vie, on appelle à votre meilleure gestion en privilégiant la réutilisation ou le recyclage dans une perspective d'économie circulaire.

lebenszyklus

Die Umweltbelastung unserer Produkte prägt jede Phase ihres Lebenszyklus – die Gewinnung und das Transport der Rohstoffe, die Produktion, die Lieferung, der Gebrauch, die Entsorgung. Margres verniedlicht durch gute Programme des Umweltmanagements die Umweltbelastung.

In der Phase des Gebrauchs und der Entsorgung bitten wir Sie um eine bevorzugte Auswahl von Weiterverwenden oder Recycling.

ciclo de vida

Os impactos ambientais dos nossos produtos distribuem-se ao longo do seu ciclo de vida, nas etapas extração, transporte de matérias-primas, produção, distribuição, uso e fim de vida. A Margres minimiza estes impactes ambientais, através de boas práticas de gestão ambiental.

No uso e fim de vida, apelamos à vossa melhor gestão, privilegiando a reutilização ou a reciclagem numa perspectiva de economia circular.

index

colour map

collections

linea collections

useful information

calibers

certification

general sales conditions

important notes

laying suggestions

magres green

outdoor extra thick

package

pr()tect

symbols

technical information

think zero

technical information

technical features

données techniques . technischen eigenschaften . características técnicas

| technical features caractéristiques techniques técnicas eigenschaften características técnicas | test method méthode d'essai prüfmethode norma de ensaio | prescribed value valeur prescrite vorgeschriebener wert valor da norma ISO 13006 / EN 14411 | typical value valeur typique typischer wert valor típico | MARGRES |
|---|--|--|---|---------|
| size - length and width . dimension - longueur et largeur abmessungen - länge und breite . dimensão - comprimento e largura | ISO 10545 - 2 | rectified ±0,3%, max. ± 1 mm not rectified ±0,6%, max. ± 2 mm | conform . conforme gemäß . conforme | |
| side straightness . rectitude des arêtes kantengeradheit . rectilinearidade das arestas | | rectified ±0,3%, max. ± 0,8 mm not rectified ±0,5%, max. ± 1,5 mm | conform . conforme gemäß . conforme | |
| rectangularity . orthogonalité rechtwinkligkeit . ortogonalidade | | rectified ±0,3%, max. ± 1,5 mm not rectified ±0,5%, max. ± 2 mm | conform . conforme gemäß . conforme | |
| warpage . planéité ebenflächigkeit . planaridade | | rectified ±0,4%, max. ± 1,8 mm not rectified ±0,5%, max. ± 2 mm | conform . conforme gemäß . conforme | |
| thickness . épaisseur dicke . espessura | | ±5%, max. ± 0,5 mm | conform . conforme gemäß . conforme | |
| water absorption . absorcion d'eau wasseraufnahme . absorção de água | ISO 10545-3 | ≤ 0,5% | conform . conforme gemäß . conforme | |
| modulus of rupture . module de rupture biegung modul . módulo de ruptura | ISO 10545 - 4 | ≥ 35N/mm ² | conform . conforme gemäß . conforme | |
| breaking strength (s) . résistance à la flexion (s) biegefestigkeit (s) . resistência à flexão (s) | | ≥ 1300 N | conform . conforme gemäß . conforme | |
| deep abrasion resistance . résistance à l'abrasion profonde widerstand gegen tiefenverschleiß . resistência à abrasão profunda | ISO 10545-6 | ≤ 175 mm ³ | conform . conforme gemäß . conforme | |
| linear thermal expansion . dilatation thermique linéaire lineare wärmeausdehnung . dilatação térmica linear | ISO 10545-8 | as indicated by manufacturer comme indiqué par le producteur wie vom hersteller angegeben conforme indicado pelo fabricante | conform . conforme gemäß . conforme | |
| thermal shock resistance . résistance au chocs thermique temperaturwechselbeständigkeit . resistência ao choque térmico | ISO 10545 - 9 | required . nécessaire anforderung . exigida | resistant . résistant beständig . resistente | |
| frost resistance . résistance au gel frostbeständigkeit . resistência ao gelo | ISO 10545 - 12 | required . nécessaire anforderung . exigida | resistant . résistant beständig . resistente | |
| chemical resistance . résistance à l'attaque chimique chemische beständigkeit . resistência ao ataque químico | ISO 10545 - 13 | as indicated by manufacturer comme indiqué par le producteur wie vom hersteller angegeben conforme indicado pelo fabricante | LA - HA resistant . résistant beständig . resistente | |
| stain resistance . résistance aux taches beständigkeit gegen fleckenbildner . resistência às manchas | ISO 10545 - 14 | as indicated by manufacturer comme indiqué par le producteur wie vom hersteller angegeben conforme indicado pelo fabricante | resistant . résistant beständig . resistente | |

It is guaranteed the compliance with the values required by norm EN 14411_Group Bla UGL. Typical Value is merely indicative, which can vary from real data, and does not have the purpose of any trading proposal.
Le respect de la norme EN14411_Group Bla UGL est garanti. La valeur typique annoncée étant indicative, pouvant varier de la valeur réelle, n'ayant pas la nature d'une proposition à caractère.
Es wird die Einhaltung der in der Norm EN 14411_Group Bla UGL geforderten Werte garantiert. Der angegebene Wert ist lediglich ein Richtwert, der von den tatsächlichen Daten abweichen kann und nicht Teil des Handelsvertrages darstellt.
É garantido o cumprimento da norma EN 14411_Group Bla UGL. O valor típico anunciado é meramente indicativo, podendo variar dos dados reais, não tendo a natureza de proposta negociada.

The technical characteristics stated in this catalogue do not invalidate the consultation of updated information on the website and technical data sheets.
Les caractéristiques techniques déclarées dans ce catalogue n'empêchent pas la consultation de l'information à jour dans le site web et fiches techniques.
Die in diesem Katalog angegebenen technischen Eigenschaften verzichtet nicht auf das Lesen der aktualisierten Informationen und der technischen Datenblätter auf der Website.
As características técnicas declaradas neste catálogo, não invalidam a consulta de informação atualizada no site e Fichas Técnicas.

ISO 13006-Annex G (Grupo Bla UGL)
EN 14411-Annex G (Grupo Bla UGL)

technical information

technical features

données techniques . technischen eigenschaften . características técnicas

| technical features caractéristiques techniques técnicas eigenschaften características técnicas | test method méthode d'essai prüfmethode norma de ensaio | prescribed value valeur prescrite vorgeschriebener wert valor da norma ISO 13006 / EN 14411 | typical value valeur typique typischer wert valor típico | LINEA |
|--|--|--|---|--|
| size - length and width . dimension - longueur et largeur abmessungen - länge und breite . dimensão - comprimento e largura | ISO 10545 - 2 | rectified ±0,3%, max. ± 1 mm not rectified ±0,6%, max. ± 2 mm | conform . conforme gemäß . conforme | |
| side straightness . rectitude des arêtes kantengeradheit . rectilinearidade das arestas | | rectified ±0,3%, max. ± 0,8 mm not rectified ±0,5%, max. ± 1,5 mm | conform . conforme gemäß . conforme | |
| rectangularity . orthogonalité rechtwinkligkeit . ortogonalidade | | rectified ±0,3%, max. ± 1,5 mm not rectified ±0,5%, max. ± 2 mm | conform . conforme gemäß . conforme | |
| warpage . planéité ebenflächigkeit . planaridade | | rectified ±0,4%, max. ± 1,8 mm not rectified ±0,5%, max. ± 2 mm | conform . conforme gemäß . conforme | |
| thickness . épaisseur dicke . espessura | | ±5%, max. ± 0,5 mm | conform . conforme gemäß . conforme | |
| water absorption . absorcion d'eau wasseraufnahme . absorção de água | ISO 10545-3 | ≤ 0,5% | conform . conforme gemäß . conforme | 0,1% (*) |
| modulus of rupture . module de rupture biegung modul . módulo de ruptura | ISO 10545-4 | ≥ 35 N/mm ² | conform . conforme gemäß . conforme | 50 N/mm ² |
| deep abrasion resistance . résistance à l'abrasion profonde beständigkeit gegen tiefenverschleiß . resistência à abrasão profunda | ISO 10545-6 | ≤ 175 mm ³ | conform . conforme gemäß . conforme | conform . conforme gemäß . conforme |
| linear thermal expansion . dilatation thermique linéaire lineare wärmeausdehnung . dilatação térmica linear | ISO 10545-8 | as indicated by manufacturer comme indiqué par le producteur wie vom hersteller angegeben conforme indicado pelo fabricante | conform . conforme gemäß . conforme | a ≤ 7x10 ⁻⁶ °C ⁻¹ |
| frost-resistance . résistance au gel frostbeständigkeit . resistência ao gelo | ISO 10545-12 | required . nécessaire anforderung . exigida | resistant . résistant beständig . resistente | resistant . résistant beständig . resistente |
| chemical resistance . résistance à l'attaque chimique chemische beständigkeit . resistência ao ataque químico | ISO 10545 - 13 | as indicated by manufacturer comme indiqué par le producteur wie vom hersteller angegeben conforme indicado pelo fabricante | LA - HA resistant . résistant beständig . resistente | LA - HA resistant . résistant beständig . resistente LB-HB polished . poli . poliert . polido smooth |
| stain resistance . résistance aux taches fleckenbeständigkeit . resistências às manchas | ISO 10545-14 | as indicated by manufacturer comme indiqué par le producteur wie vom hersteller angegeben conforme indicado pelo fabricante | resistant . résistant beständig . resistente | 5 resistant . résistant beständig . resistente ≥ 3 polished . poli . poliert . polido smooth |
| fire reaction . réaction au feu brandverhalten . reação ao fogo | EN 13823 EN 9239-1 | CPR (UE) 305/2011, 2000/147/E, UNI EN 13501-1 | conform . conforme gemäß . conforme | Class A1 - 6mm Class A2-s1,d0 - 5,5mm . 3,5mm (walls, mur, wand, revestimento) Class A1 _{f1} - 6mm Class A2 _{f1} -s1 - 5,5mm . 3,5mm (floor, sol, boden, pavimento) |
| thermal conductivity . conductivité thermique wärmeleitfähigkeit . condutividade | EN 12524 | - | conform . conforme gemäß . conforme | λ = 1,3 W/m °K λ = 0.7 BTU/ft.h °F |

(*) Average value referred to ceramic material only . Valeur moyenne se référant au matériau céramique . Durchschnittswert bezogen auf das Keramikmaterial . Valor médio refere-se apenas o material cerâmico.

It is guaranteed the compliance with the values required by norm EN 14411_Group Bla UGL. Typical Value is merely indicative, which can vary from real data, and does not have the purpose of any trading proposal.
Le respect de la norme EN14411_Group Bla UGL est garanti. La valeur typique annoncée étant indicative, pouvant varier de la valeur réelle, n'ayant pas la nature d'une proposition à caractère.
Es wird die Einhaltung der in der Norm EN 14411_Group Bla UGL geforderten Werte garantiert. Der angegebene Wert ist lediglich ein Richtwert, der von den tatsächlichen Daten abweichen kann und nicht Teil des Handelsvertrages darstellt.
É garantido o cumprimento da norma EN 14411_Group Bla UGL. O valor típico anunciado é meramente indicativo, podendo variar dos dados reais, não tendo a natureza de proposta negociada.

Linea is not intended for use in areas subject to the passage of heavy concentrated loads (for example, hard-wheeled trolleys).
Linea n'est pas conçu pour être utilisé dans des zones soumises au passage de charges lourdes et concentrées (par exemple, des chariots à roues rigides).
Linea ist nicht für den Einsatz in Bereichen bestimmt, in denen konzentrierte, schwere Lasten bewegt werden (z. B. Wagen mit harten Rädern).
Linea não é indicado para utilização em zonas sujeitas a passagem de cargas pesadas concentradas (por exemplo, carrinhos com rodas rígidas).

The technical characteristics stated in this catalogue do not invalidate the consultation of updated information on the website and technical data sheets.
Les caractéristiques techniques déclarées dans ce catalogue n'empêchent pas la consultation de l'information à jour dans le site web et fiches techniques.
Die in diesem Katalog angegebenen technischen Eigenschaften verzichtet nicht auf das Lesen der aktualisierten Informationen und der technischen Datenblätter auf der Website.
As características técnicas declaradas neste catálogo, não invalidam a consulta de informação atualizada no site e Fichas Técnicas.

MARGRES
CERAMIC TILES

index

colour map

collections

linea collections

useful information

calibers

certification

general sales
conditions

important notes

laying suggestions

magres green

outdoor extra thick

package

pr()tect

symbols

technical information

think zero

calibers

calibres . kaliber . calibres

calibers

calibres . kaliber . calibres

| size format formato formato (cm) | thickness épaisseur dicke espesura | P | X | V | S | T | C | R |
|---|---|-----------------|---------------|---------------|---------------|-----------------|----------------|----------------|
| 120x120 | 9mm | 1198,0 x 1198,0 | | | | 1201,6 x 1201,6 | | |
| 90x90 | 9,5 mm | - | 895,0 x 895,0 | 890,0 x 890,0 | - | - | - | - |
| | 10,5 mm | - | 895,0 x 895,0 | 890,0 x 890,0 | - | - | - | - |
| | 11,0 mm | - | 895,0 x 895,0 | 890,0 x 890,0 | - | - | - | - |
| | 20,0 mm | 898,0x898,0 | - | - | - | - | - | - |
| 89x89 | 9,5 mm | - | - | 890,0 x 890,0 | - | - | - | - |
| 88x88 | 9,5 mm | - | - | - | 881,0 x 881,0 | - | - | - |
| 60x120 | 9,5 mm Prestige + Endless | - | - | - | - | - | 595,0 x 1192,0 | 592,0 x 1187,0 |
| | 9,5 mm | - | - | - | - | 599,8 x 1201,6 | - | - |
| | 10,5 mm | - | - | - | - | 599,8 x 1201,6 | - | - |
| | 11,0 mm | - | - | - | - | 599,8 x 1201,6 | - | - |
| | 20,0 mm | 598,0x1198,0 | - | - | - | - | - | - |
| 60x60 | 8,5 mm Prestige | - | - | - | - | - | 595,0 x 595,0 | 592,0x592,0 |
| | 8,5 mm | - | - | - | - | 599,8 x 599,8 | 595,0 x 595,0 | - |
| | 9,5 mm | - | - | - | - | 599,8 x 599,8 | 595,0 x 595,0 | - |
| | 10,0 mm | - | - | - | - | 599,8 x 599,8 | 595,0 x 595,0 | - |
| | 14,0 mm | - | - | - | - | 599,8 x 599,8 | 595,0 x 595,0 | - |
| | 20,0 mm | 598,0 x 598,0 | - | - | - | - | 595,0 x 595,0 | - |
| 45x90 | 9,0 mm | - | 446,5 x 895,0 | 444,0 x 890,0 | - | - | - | - |
| 30x60 | 8,5 mm | - | - | - | - | 298,9 x 599,8 | 296,5 x 595,0 | - |
| | 9,5 mm | - | - | - | - | 298,9 x 599,8 | 296,5 x 595,0 | - |
| | 10,0 mm | - | - | - | - | 298,9 x 599,8 | 296,5 x 595,0 | - |

| size format formato formato (cm) | thickness épaisseur dicke espesura | A | B | D | E | H | L | M |
|---|---|---------------|---------------|---------------|---------------|---------------|---------------|---------------|
| 30x30 | 8,5 mm | 296,1 x 296,1 | 297,4 x 297,4 | 298,7 x 298,7 | 300,0 x 300,0 | 301,3 x 301,3 | 302,6 x 302,6 | 303,9 x 303,9 |
| | 12,0 mm | 296,1 x 296,1 | 297,4 x 297,4 | 298,7 x 298,7 | 300,0 x 300,0 | 301,3 x 301,3 | 302,6 x 302,6 | 303,9 x 303,9 |
| 20x90 | 9,0 mm | - | 200,0 x 896,0 | 200,4 x 898,0 | 200,9 x 900,0 | 201,3 x 902,0 | 201,8 x 904,0 | - |

| size format formato formato (cm) | thickness épaisseur dicke espesura | P | K | J | B | C | D | E | H | L |
|---|---|----------------|----------------|----------------|----------------|----------------|----------------|----------------|----------------|----------------|
| 40x120 | 20,0 mm | 398,0 x 1198,0 | - | - | - | - | - | - | - | - |
| 20x120 | 8,0 mm | - | - | - | 202,5 x 1200,1 | 203,0 x 1201,4 | 203,5 x 1202,7 | 204,0 x 1204,0 | 204,5 x 1205,3 | 205,0 x 1206,0 |
| | 8,0 mm NR | - | 192,0 x 1192,0 | 196,0 x 1196,0 | - | - | - | - | - | - |
| | 9,5 mm Stage | - | - | - | - | - | - | - | 198,0 x 1200,0 | - |

LIN3A

| size format formato formato (cm) | thickness épaisseur dicke espesura | 3plus mm |
|---|---|-----------------|
| 100x300 | 3,5 mm | 1000,0 x 3000,0 |
| 100x100 | 3,5 mm | 1000,0 x 1000,0 |
| 50x100 | 3,5 mm | 500,0 x 1000,0 |

| size format formato formato (cm) | thickness épaisseur dicke espesura | 5plus mm |
|---|---|----------------|
| 100x300 | 5,5 mm | 997,0 x 3000,0 |
| 100x250 | 5,5 mm | 997,0 x 2500,0 |
| 100x100 | 5,5 mm | 997,0 x 997,0 |
| 50x100 | 5,5 mm | 497,0 x 997,0 |

| size format formato formato (cm) | thickness épaisseur dicke espesura | 6 mm |
|---|---|-----------------|
| 120x260 | 6,0 mm | 1198,0 x 2600,0 |
| 120x120 | 6,0 mm | 1198,0 x 1198,0 |
| 100x300 | 6,0 mm | 997,0 x 3000,0 |
| 100x250 | 6,0 mm | 997,0 x 2500,0 |
| 100x100 | 6,0 mm | 997,0 x 997,0 |
| 60x120 | 6,0 mm | 598,0 x 1198,0 |
| 50x100 | 6,0 mm | 497,0 x 997,0 |

index

colour map

collections

linea collections

useful information

calibers

certification

general sales
conditions

important notes

laying suggestions

magres green

outdoor extra thick

package

pr()tect

symbols

technical information

think zero

symbols

— symbologie . zeichen . simbologia

FULL BODY PORCELAIN

Full Body Porcelain
Grès Cérame Pleine Masse
Durchgefärbtes Feinsteinzeug
Grés Porcelânico Toda a Massa

DIGITEK PORCELAIN STONEWARE

Fully digital graphics
Graphisme totalement digital
Komplett digitale Grafik
Produto com gráfica totalmente digital

LAMINATED PORCELAIN STONEWARE

Reduced thickness porcelain tile
Grés cérame fine épaisseur
Feinsteinzeug mit geringerer Dicke
Grés Porcelânico de baixa espessura

TECHNICAL FULL BODY PORCELAIN

Technical Full Body Porcelain
Grès Cérame Pleine Masse Technique
Technishes, Durchgefärbtes Feinsteinzeug
Grés Porcelânico Toda a Massa Técnico

UGL

Unglazed
Non émaillé
Unglasierte
Não esmaltado

M²

Decors sold per Sqm (m²)
Décorations vendues au m²
Dekorationen verkauft pro m²
Decorações vendidas a m²



Low traffic
Faible passage
Leicht Frequentiert
Baixo tráfego



Medium traffic
Passage modéré
Mittlere Frequentierung
Médio tráfego



Medium high traffic
Passage modéré à élevé
Mittlere bis starke Frequentierung
Médio alto tráfego



High traffic
Fort Passage
Starke Frequentierung
Alto tráfego

PR()TECT

Antibacterial for Life.

An exclusive line of extremely high performance antimicrobial floor and wall tiles, designed for healthy, safe and protected living spaces.
Une ligne exclusive de sols et revêtements antibactériens aux performances très élevées, pour un habitat sain, sûr et protégé.
Eine exklusive Linie an hochwertigen Fußböden und antibakteriellen Wandverkleidungen, für ein gesundes, sicheres und geschütztes Leben.
Uma linha exclusiva de pavimentos e revestimentos antimicrobianos de altíssima performance, projetada para ambientes saudáveis, seguros e protegidos.

laying suggestions

— suggestions de pose . anwendungsvorschläge . sugestões de aplicação —

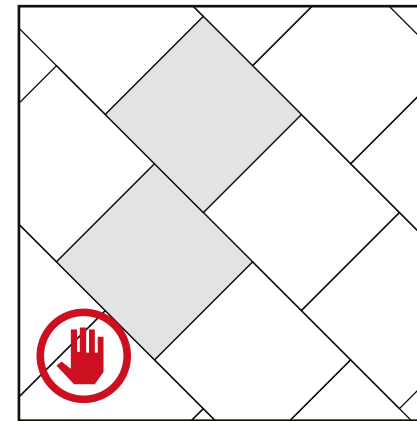
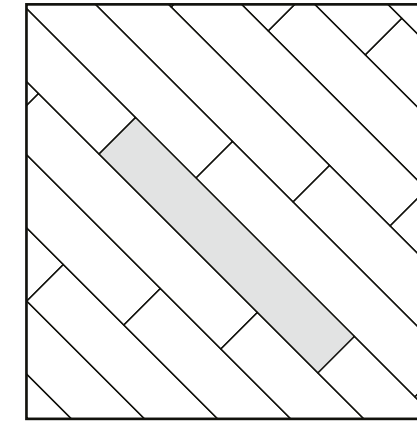
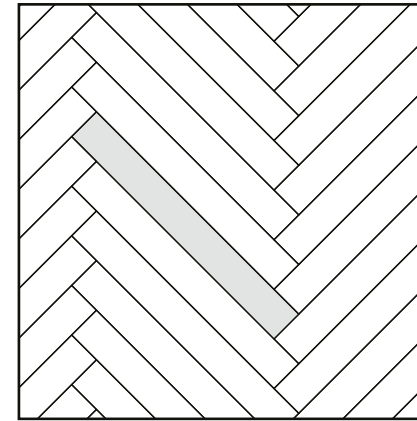

Not recommended
Non recommandé
Nicht empfohlen
Não recomendado

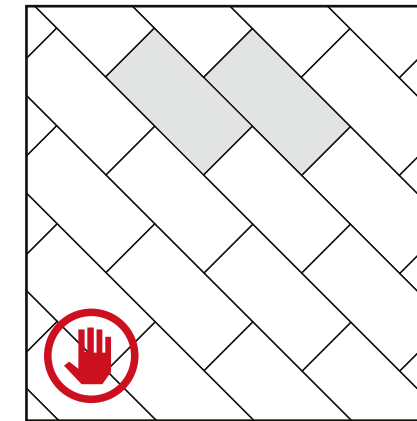

Not recommended
Non recommandé
Nicht empfohlen
Não recomendado

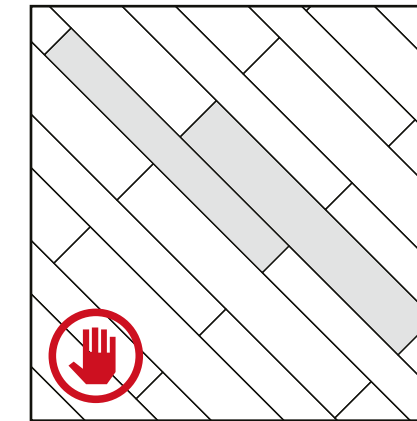

Not recommended
Non recommandé
Nicht empfohlen
Não recomendado

MARGRES
CERAMIC TILES

Gres Panaria Portugal S.A
Chousa Nova - 3830-133 Ílhavo - PORTUGAL

e-mail: margres@margres.com
www.margres.com



APICER
associação portuguesa das indústrias
de cerâmica e cristalaria



projeto gráfico: Viriato & Viriato
coordenação: Marketing Margres
fotografia: MHP - Viriato & Viriato
impressão: Viriato & Viriato
edição de janeiro 2024

[index](#)

[colour map](#)

[collections](#)

[linea collections](#)

[useful information](#)

MARGRES

CERAMIC TILES